

# Guía de Soluciones Extensores HDMI



# Familia de Productos

Extensores  
HDMI por UTP

TT-372-EDID  
TT-383-PRO  
TT-383-PRO-RX  
TT-683  
TT-683-RX  
TT-672  
TT-372-W  
TT-383-W  
TT-383-VGA  
TT-371-KVM



Extensor HDMI  
Inalámbrico

TT-388-A  
TT-388-A-RX  
TT-388-Dongle  
TT-388-M  
TT-388-M-RX  
TT-688  
TT388US-500  
TT388M-DUAL  
TT388-DM  
TT388-DM-RX  
TT388-MINI



Extensor HDMI  
sobre Línea  
Eléctrica

TT-380-PRO  
TT-380-PRO-RX



Divisor HDMI

TT-312-V2.0  
TT-314-PRO  
TT-318-PRO  
TT-314-4K-  
HDbiT-TX  
TT-714-PRO  
TT-718-PRO  
TT-312HDR-2.0  
TT-314HDR-2.0  
TT-318EDID-V2.0



Matrix HDMI

TT-383-Matrix  
TT-683-Matrix  
TT-383-Matrix-RX  
TT-683-Matrix-RX  
TT-414  
TT-818



Switch  
Multiviewer  
Video Wall  
HDMI Switch

TT-401MS  
TT-314VW  
TT-501-V2.0



Mini  
Convertidor  
Extensor  
Repetidor

TT-350-MINI  
TT-352N  
TT-352-4K  
TT-366  
TT-168-4K  
TT-7505  
TT-3061



## Extensores HDMI por UTP

---

| Modelo        | Producto      | Características  |
|---------------|---------------|--|
| TT-372-EDID   | Extensor HDMI | Full 1080P Sobre Cat6 to 60M, con IR y salida loop         |
| TT-383-PRO    | Extensor HDMI | Full 1080P Sobre Cat5/6 to 120M/150M, con IR y salida loop |
| TT-383-PRO-RX | Receptor HDMI | Full 1080P Sobre Cat5/6 to 120M/150M, con IR               |
| TT-683        | Extensor 4K   | 4K@30Hz Sobre Cat5/6 to 120M, con IR                       |
| TT-683-RX     | Extensor 4K   | 4K@30Hz Sobre Cat5/6 to 120M, con IR                       |
| TT-672        | Extensor 4K   | 4K@30Hz Sobre Cat6 to 60M,4K@60Hz to 30M, con IR           |
| TT-371-KVM    | Extensor KVM  | Full 1080P Sobre Cat6 to 60M, con IR, salida loop y KVM    |
| TT-383-VGA    | Extensor VGA  | Full 1080P Sobre Cat5/6 to 120M/150M                       |

# TT372EDID

HDMI sobre CAT6 a **50 m**, con IR y HDMI Loop-out



- HDMI sobre solo CAT6 a **50 m**
- Bucle de salida HDMI en TX para visualización local
- Soporta señal AV sin compresión y transmisión sin pérdidas
- Ajuste automático para que coincida con la longitud del cable de 1 a 50 m de CAT6
- **Sólo una fuente de alimentación en el lado del transmisor**
- Control remoto de infrarrojos
- latencia cero

## Conexión

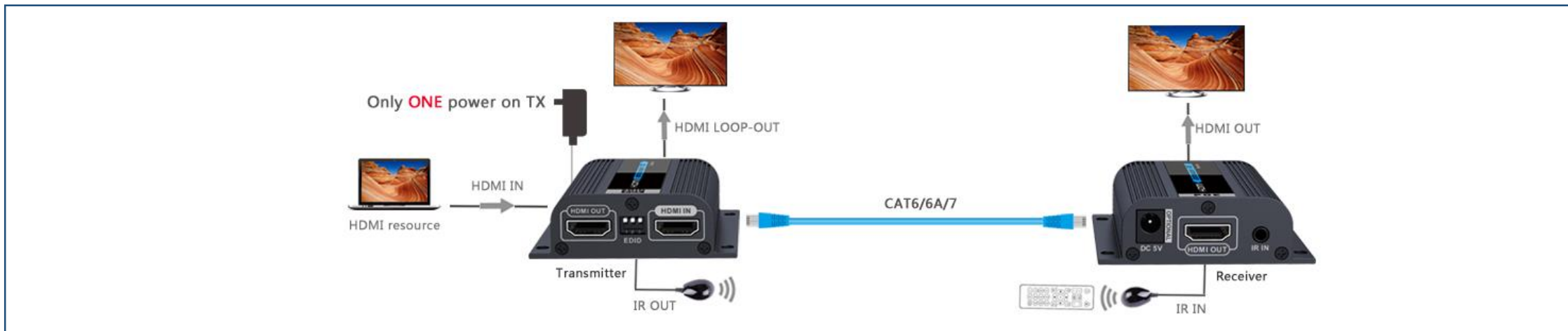

## Características

- HDMI sobre CAT/5e/6 a **120 / 150 m**
- Salida **HDMI Loop-Out**
- Transmisión de IR
- **Cascadeo** a través de switches
- No interfiere con la red existente
- Conexión **uno a muchos**

# TT383PRO

Extensor sobre UTP con salida **Loop-Out**

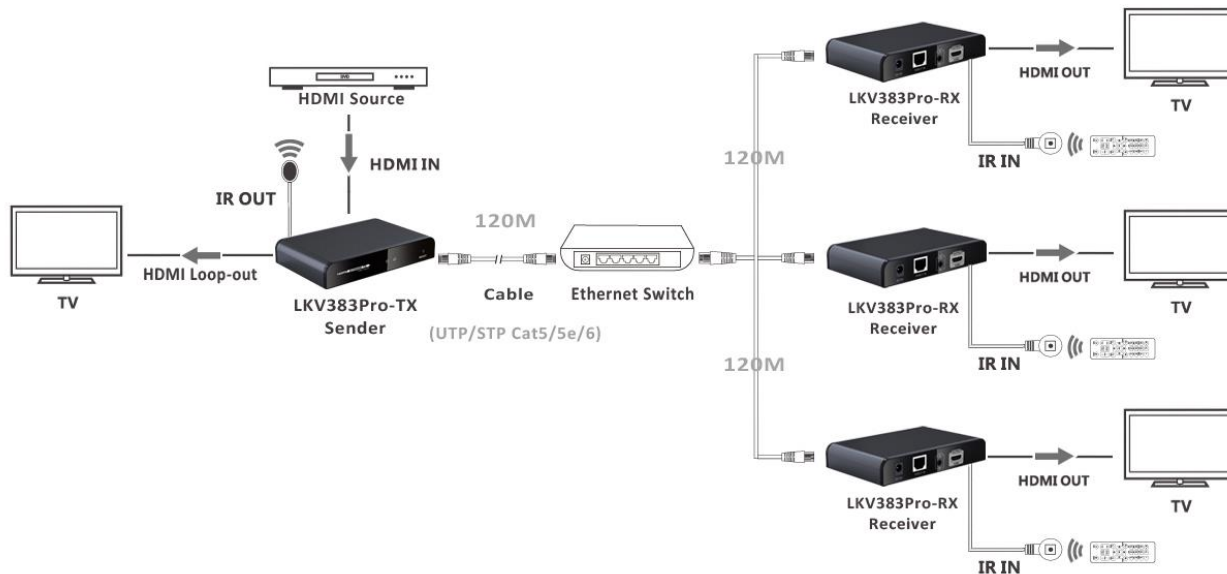

## Cascadeo con switches

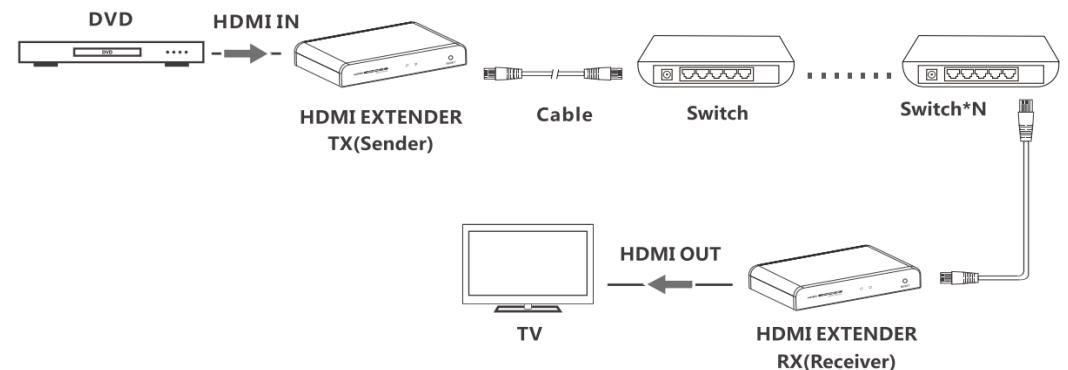

# TT683

## Extensor sobre cable UTP 4K



- 4K sobre CAT5e/6 hasta 120 / 150 m
- Transmisión de IR
- Cascado a través de switches
- Conexión uno a muchos

## Aplicación

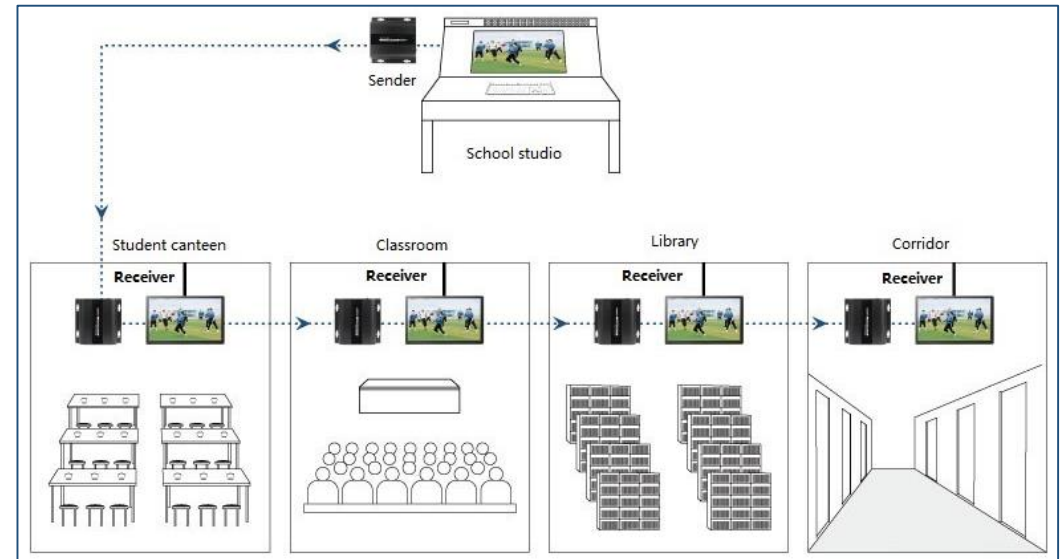
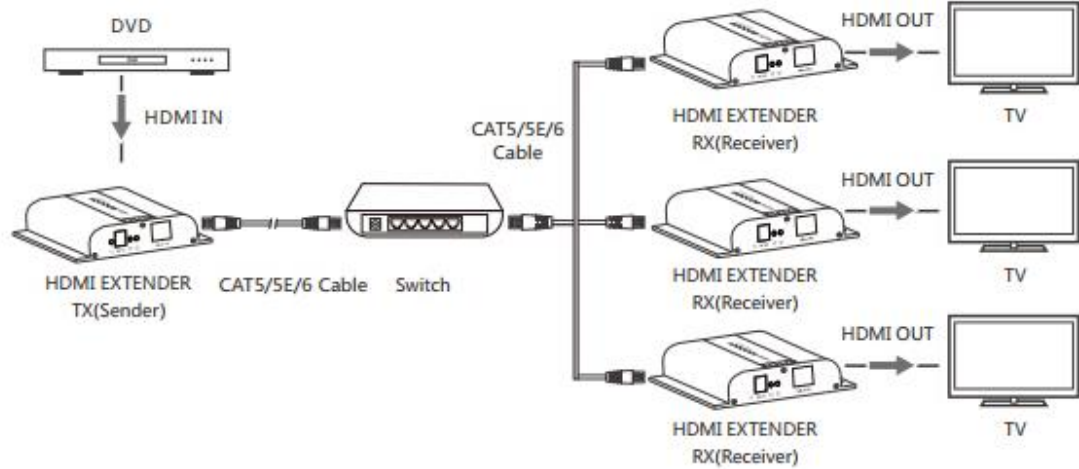



# TT672

Extensor HDMI2.0 **4K** por UTP



Zero latency



4Kx2K@30/60Hz  
ultra HD



Over CAT6  
/6A/7



20-60KHz  
IR passback

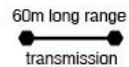

60m long range  
transmission

- HDMI2.0
- HDCP2.2
- 4K @ 30Hz sobre Cat6 a 60m
- 4K @ 60Hz sobre Cat6 a 30m
- Transmisión de IR

## Modo de conexión

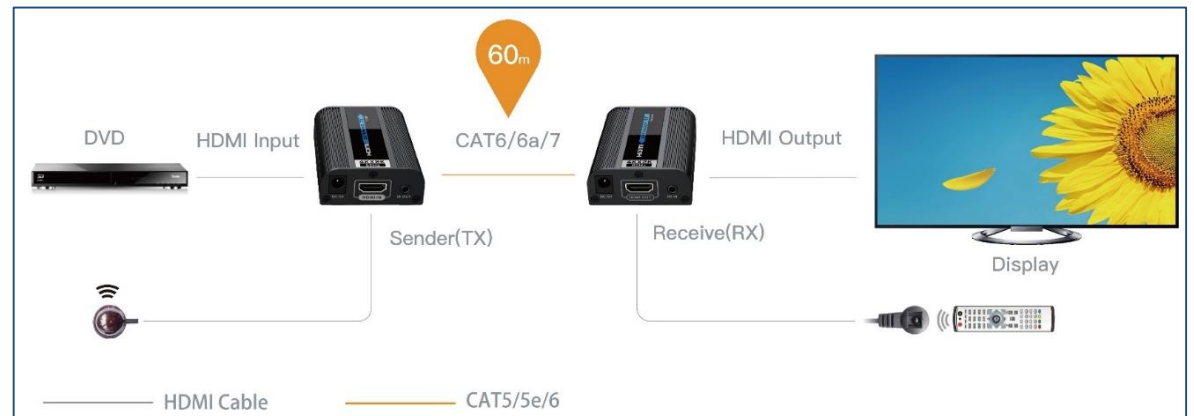

# TT371KVM

## Extensor HDMI con USB2.0



Real time



60M/CAT5



KVM



1080P HD



Compliant CAT5/5e/6



Point to point configuration

- Full 1080P sobre CAT6 a **60M**
- Con salida Loop
- Puertos USB 2.0 para KVM
- Tiempo real, latencia cero

### Modo de conexión

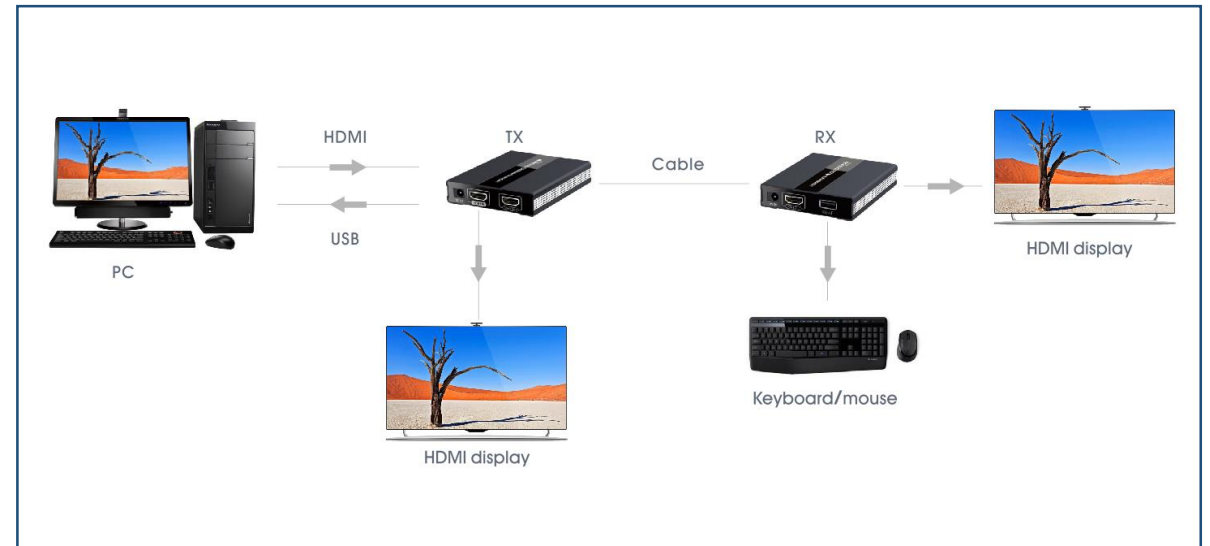



# TT383VGA

Extensor VGA hasta **120 / 150 m**



- Extensor VGA hasta **120 / 150 m**
- Cascado a través de switch
- Soporta 1TX a conexión **253 RX**
- El TX VGA es compatible con el HDMI RX

## 1) Conexión 1 a 1

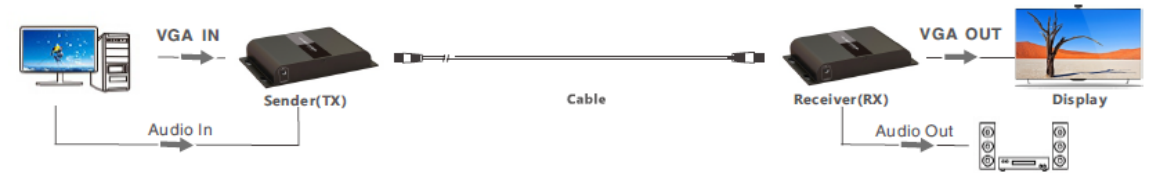

## 2) Conexión en cascada

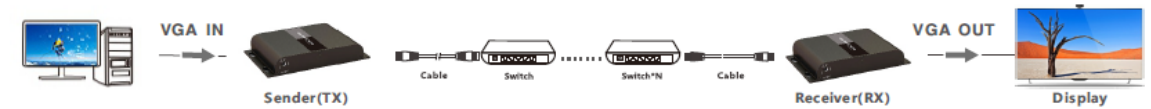

## 3) Conexión 1 a muchas

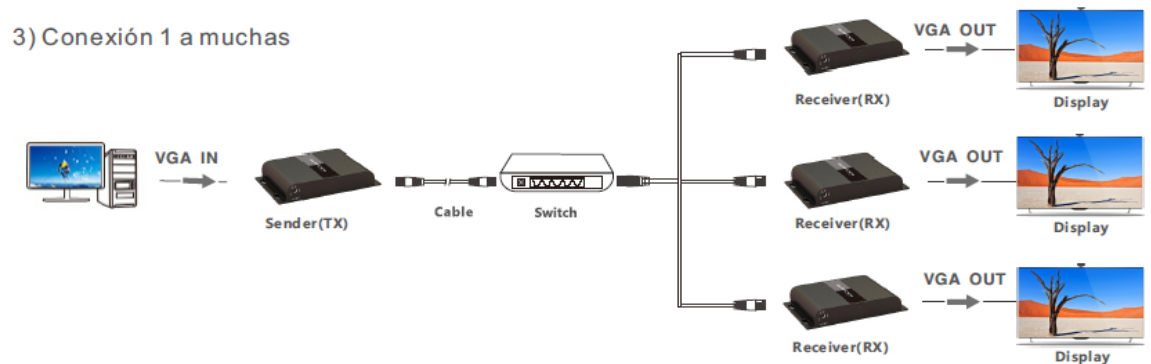

## Extensores HDMI a través de placas de pared

| Modelo   | Producto      | Características                      |
|----------|---------------|--------------------------------------|
| TT-372-W | Extensor HDMI | Full 1080P sobre Cat6 a 60M, con IR  |
| TT-383-W | Extensor HDMI | Full 1080P sobre Cat6 a 120M, con IR |

# TT383W

## Extensor de pared por cable UTP



- HDMI sobre CAT5e/6 a **120 / 150 m**
- **Placa de pared**
- **Conexión uno a muchos**
- Transmisión de IR
- Alimentación 110 /220V

### Conexión uno a uno

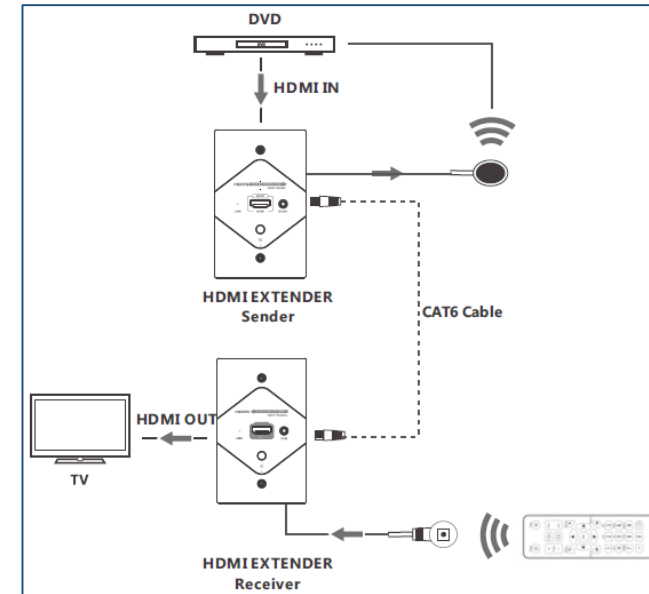

### Conexión uno a muchos

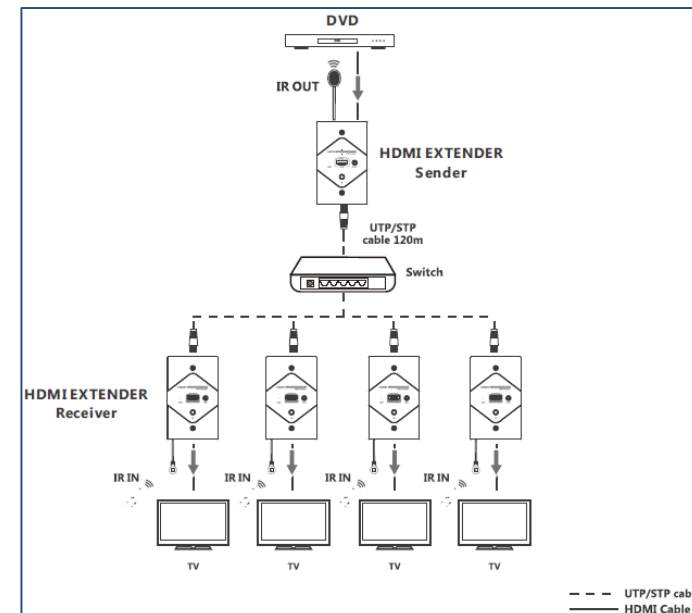

# TT372W

Extensor de pared por cable UTP



## TT372W

- HDMI sobre CAT6 a **50M**
- Placa de pared
- Transmisión de IR
- Alimentación 110/220V

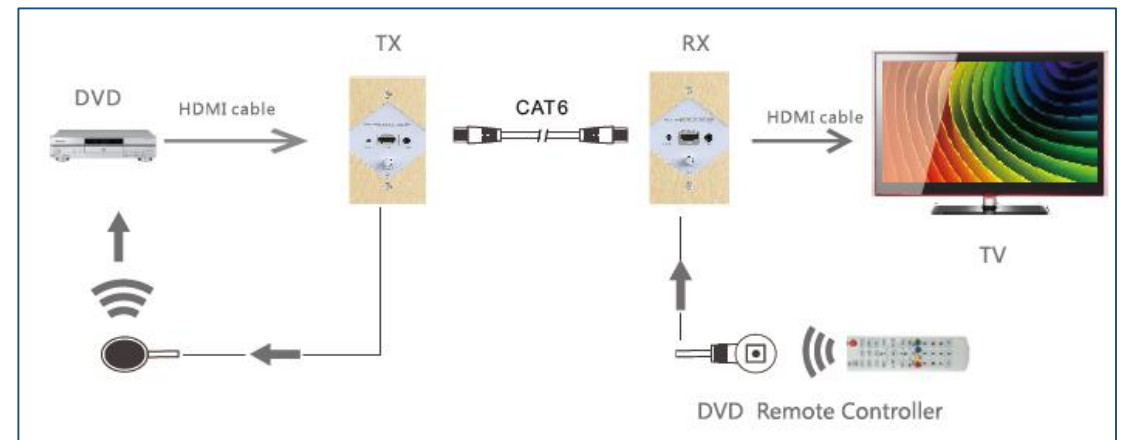

## Extensores HDMI sobre Línea Eléctrica

---

| Modelo       | Producto      | Características   |
|--------------|---------------|---|
| TT-380-PRO   | Extensor HDMI | Full 1080P sobre línea eléctrica hasta 300M, con salida loop & IR |
| TT-380PRO-RX | Extensor HDMI | Receptor Full 1080P sobre línea eléctrica                         |

# TT380PRO

Extensor sobre línea eléctrica **300 m**

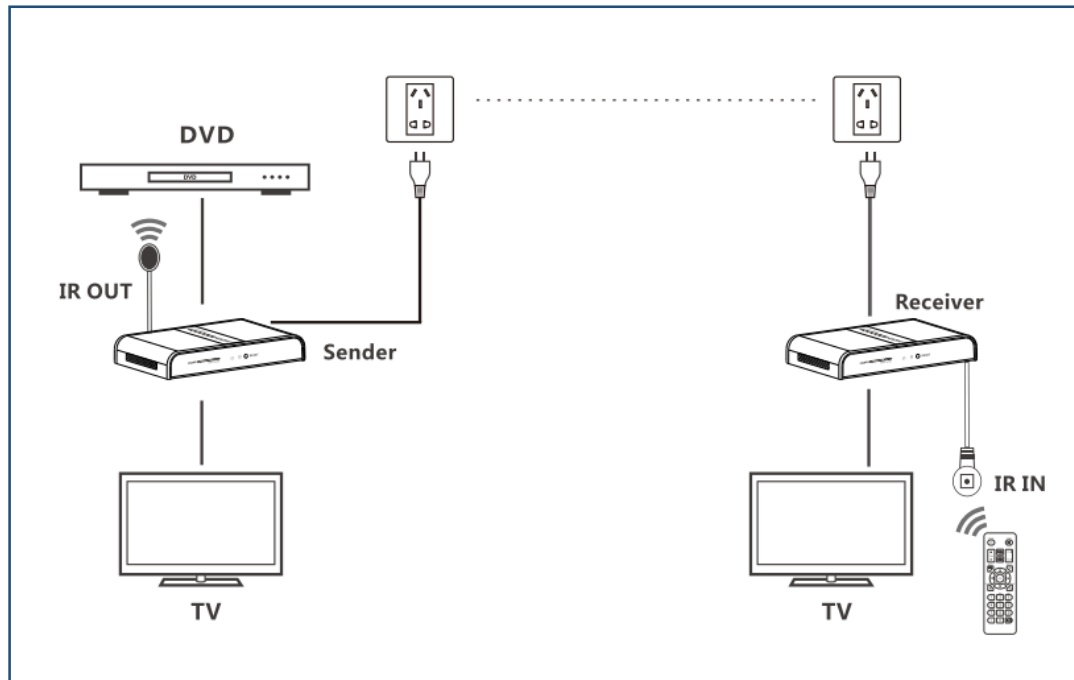

- **1080P** sobre línea eléctrica **300 m**
- Con **IR** & salida **Loop HDMI**
- Conexión **uno a cuatro** ( **TT380PRO-RX** )

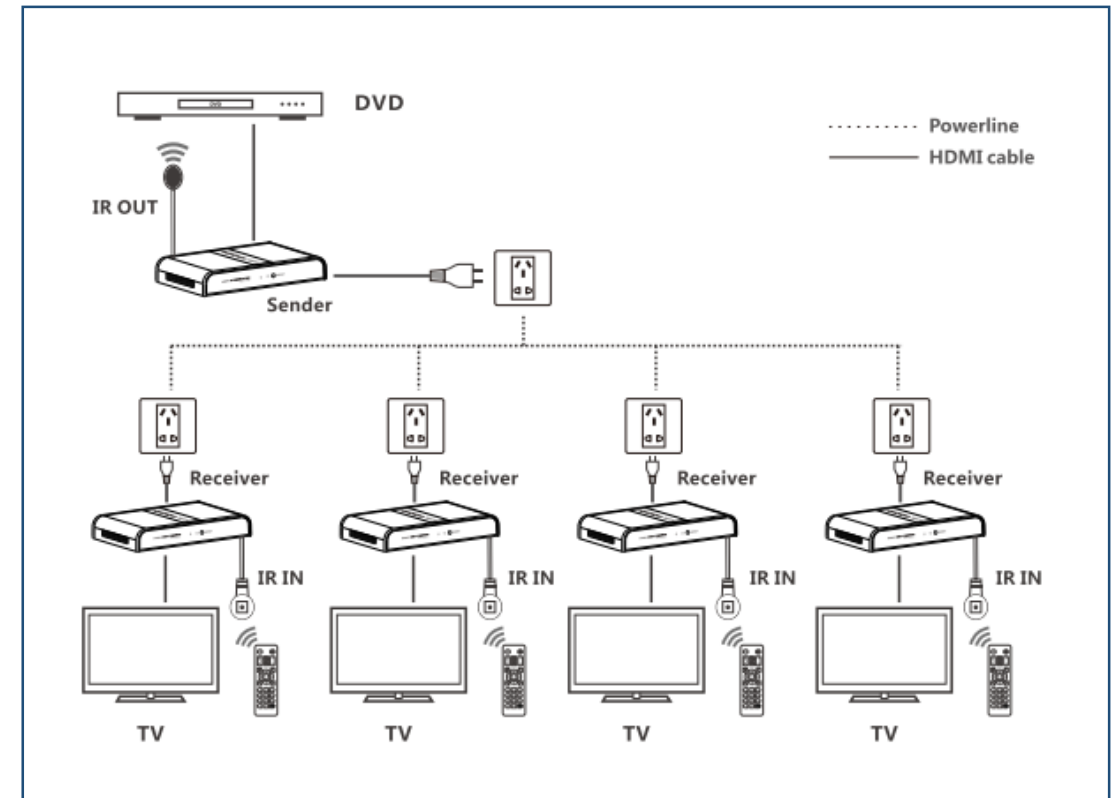



## Extensores HDMI por fibra óptica

---

| Modelo      | Producto      | Características  |
|-------------|---------------|--|
| TT-378-A-4K | Extensor HDMI | Extensor 4K x 2K sobre fibra óptica hasta 20KM, con IR |

# TT378A-4K

Extensor **4K** sobre fibra hasta **20 Km**



- Extensor **4K** sobre fibra hasta **20 Km** ( monomodo )  
**1 Km** ( multimodo )
- Con **IR**
- Conexión **uno a muchos**

## ■ Conexión uno a uno

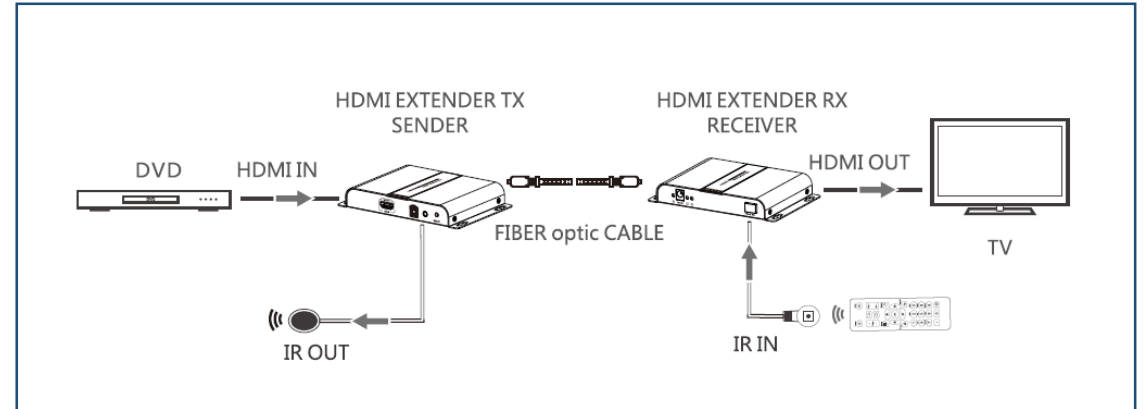

## ■ Conexión uno a muchos

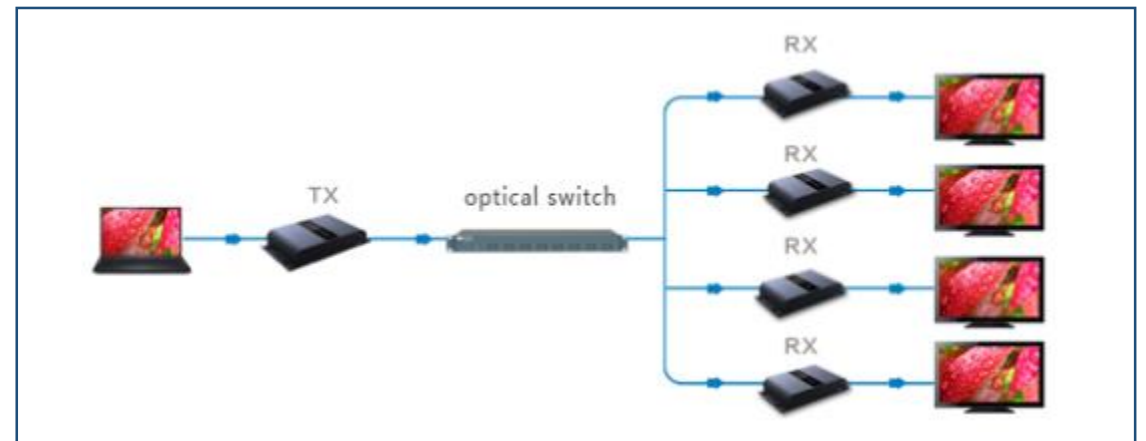

## Extensor HDMI Inalámbrico

| Modelo         | Producto                           | Características  |
|----------------|------------------------------------|--|
| TT-388-A       | 200m Extensor HDMI inalámbrico     | Extensor HDMI inalámbrico para 200m, soporta 1TX a 2RX , con IR  |
| TT-388A-RX     | 200m Receptor HDMI inalámbrico     | Receptor HDMI inalámbrico para 200m, soporta 1TX a 2RX , con IR  |
| TT-688N        | 50m 4K Extensor HDMI inalámbrico   | Extensor HDMI inalámbrico para 4K hasta 50m, salida Loop en TX   |
| TT-688         | 200m 4K Extensor HDMI inalámbrico  | Extensor inalámbrico 4K para 200m, soporta 1TX a 2RX , con IR    |
| TT-388-Dongle  | 50m Adaptador Extensor mini HDMI   | Extensor inalámbrico HDMI para 50m, para IR                      |
| TT-388-M       | 50m Extensor HDMI inalámbrico      | Extensor inalámbrico HDMI 50m, soporta 2TX a 2RX , con IR        |
| TT-388-IR      | Extensor inalámbrico de IR         | Extensor inalámbrico de IR hasta 200M                            |
| TT-388-US-500M | 500m Extensor HDMI inalámbrico     | Extensor HDMI inalámbrico para 500m, soporta 1TX a 16RX , con IR |
| TT-388M-DUAL   | 100m Extensor HDMI inalámbrico     | Extensor HDMI inalámbrico 100m, soporta 2TX a 2RX , con IR       |
| TT-388-DM      | 15m Switch inalámbrico HDMI        | Extensor HDMI inalámbrico 15m, soporta 10TX a 2RX , con IR       |
| TT-388-MINI    | 15m Mini Extensor HDMI inalámbrico | Ultra Mini Extensor HDMI inalámbrico, con IR                     |

# TT388A

Extensor inalámbrico para **200 m**



## Características

- Para **200m** inalámbricamente en **1080P**
- Control **IR**
- Conexión de **1 TX** a **2 RX**

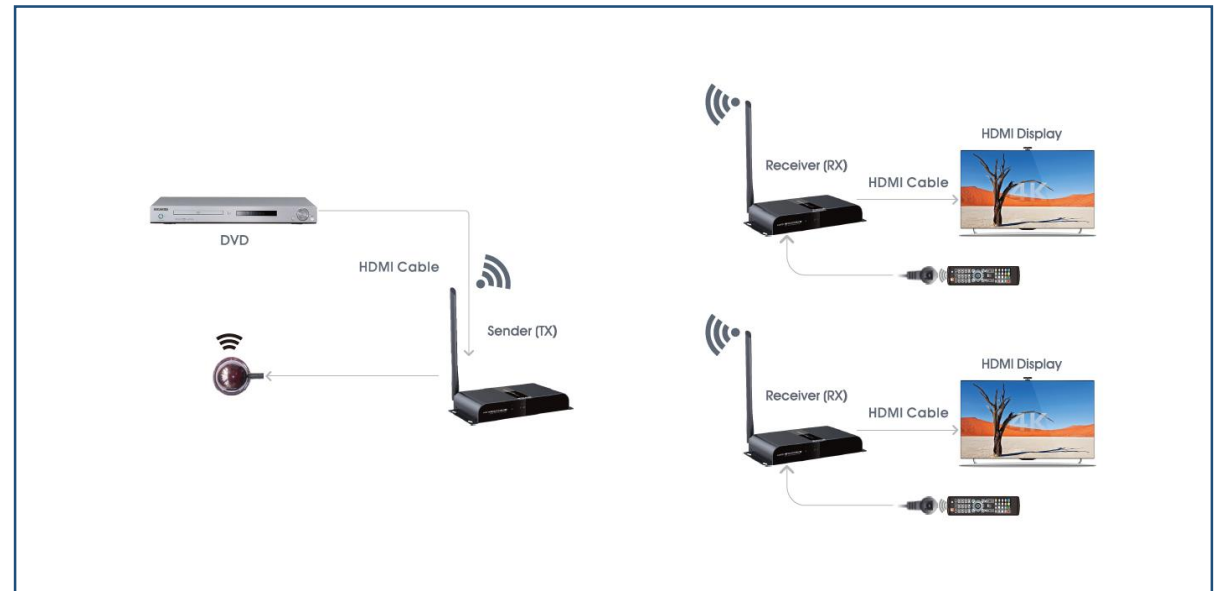

# TT388A-RX

Extensor HDMI inalámbrico para **200 m**



## Características

- Para **200 m** inalámbricamente en **1080P**
- Control **IR**
- Soporta conexión **1 TX a 2 RX**

## ■ Conexión uno a uno

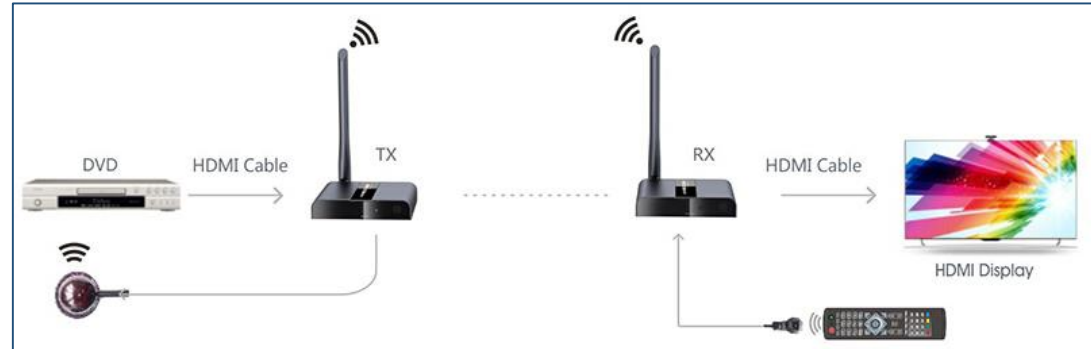

## ■ Conexión uno a dos

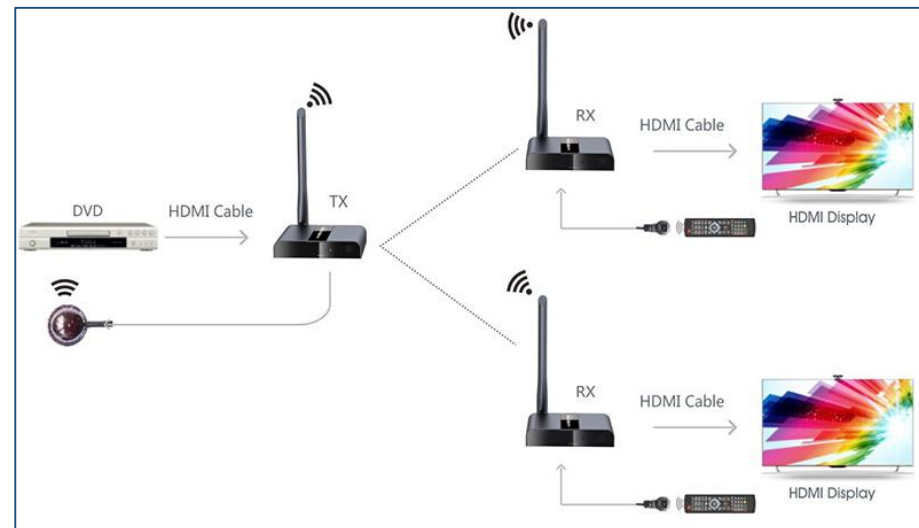

# TT688N

Extensor inalámbrico **4K** para **50 m**



## Características

- Hasta **50m** en **4K** Inalámbricamente
- Salida **loop HDMI** en TX
- Control **IR**
- Plug & Play

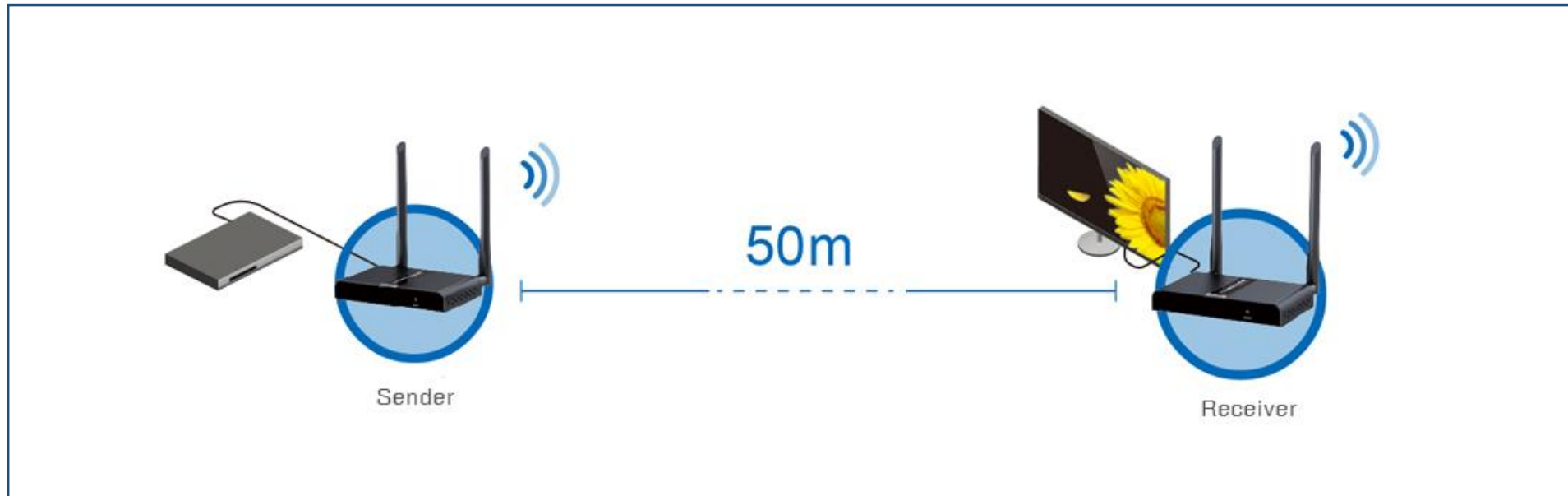



# TT688

**4K** Extensor inalámbrico HDMI **200 m**



## Características

- **4K** inalámbrico hasta **200 m**
- Control IR
- Conexión entre **1 TX** a **2 RX**
- Intercomunicación con VGA/SDI TX/RX

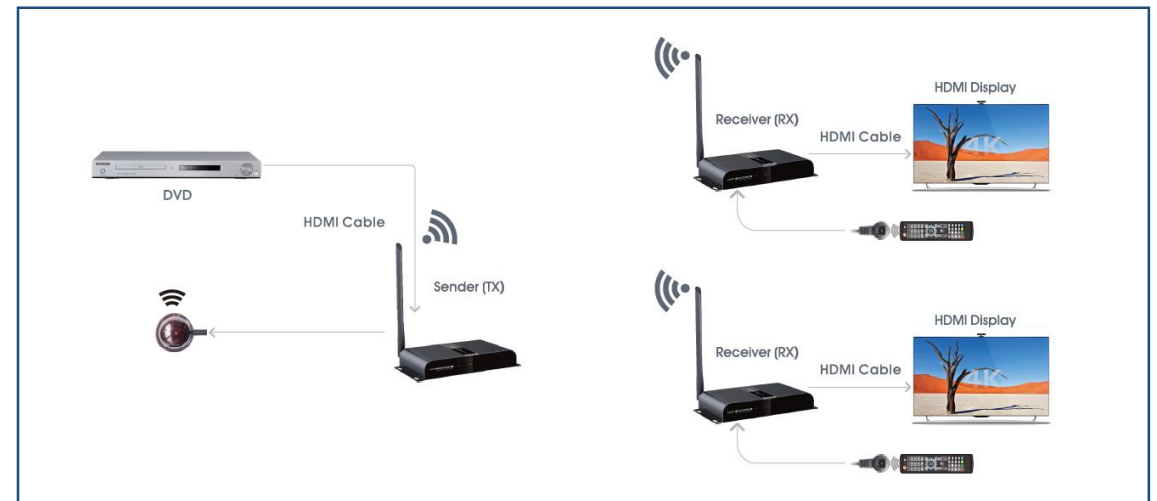

# TT388Dongle

Adaptador Inalámbrico HDMI para **50 m**



## Características

- Envía inalámbricamente **1080P** hasta **50 m**
- Control **IR**
- Alimentación USB en TX
- **HDMI macho** en TX

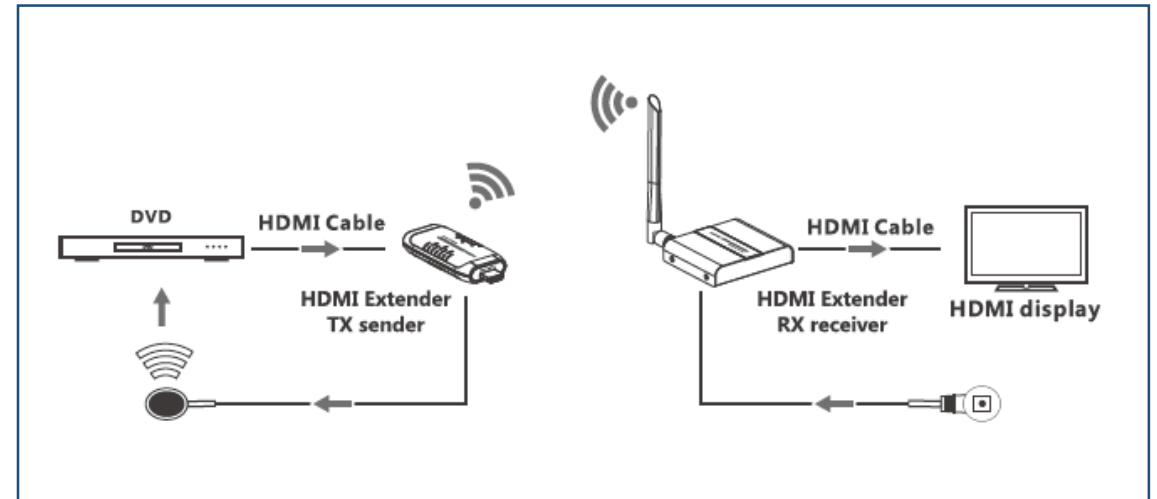

# TT388M

Extensor HDMI Inalámbrico **50 m**



## Características

- **1080P** hasta **50 m** inalámbricamente
- Control IR
- Soporta conexión **1 TX a 2RX**
- Soporta conexión **2 TX a 2RX**

### ■ Conexión uno a uno

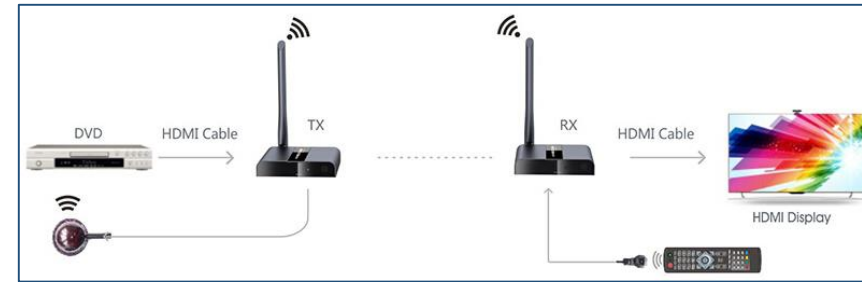

### ■ Conexión uno a dos

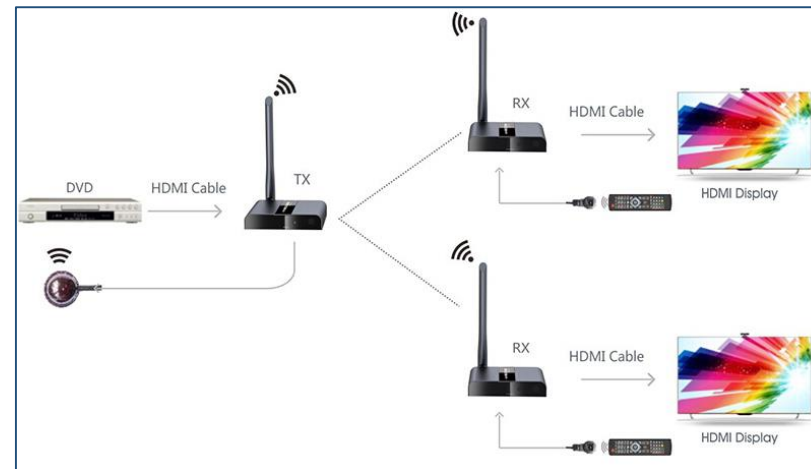

### ■ Conexión dos a dos

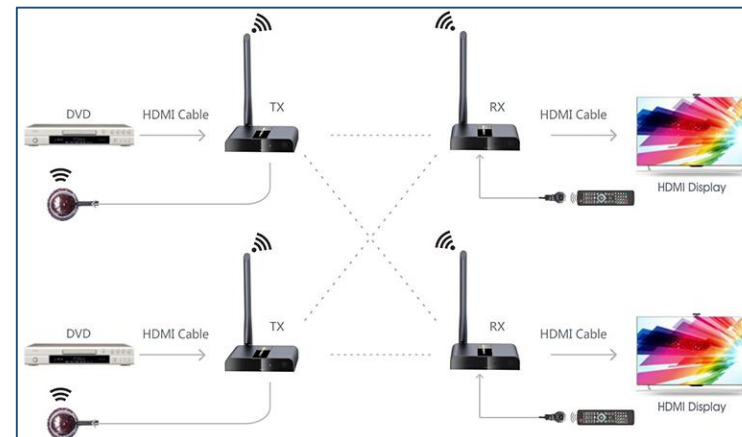

# TT388IR

Extensor inalámbrico de IR **200 m**



## Características

- Señal inalámbrica de IR hasta **200 m**
- Sin interferencia entre dispositivos
- Alta sensibilidad

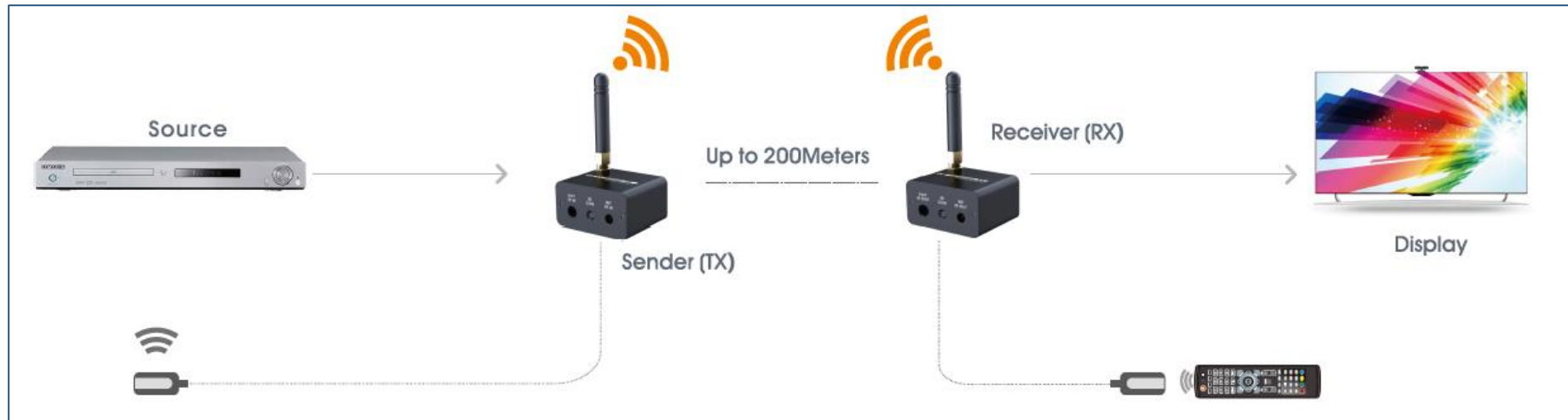

# TT388US-500

Extensor HDMI Inalámbrico para **500 m**



## Características

- Extensor HDMI Inalámbrico para **500 m**
- Soporta conexión **1 TX to 16 RX**
- Excelente señal incluso a través de muros
- Extensor de IR

## ■ Conexión y aplicación

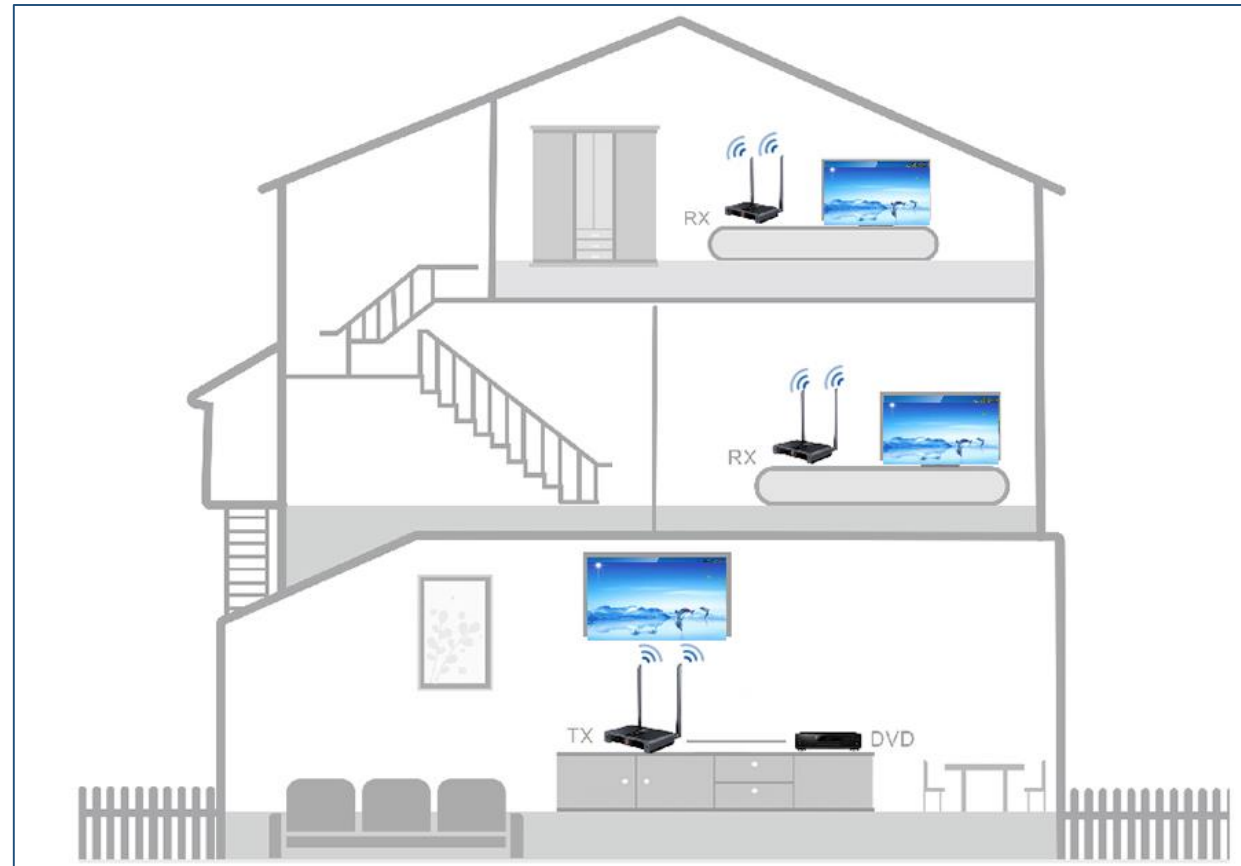

# TT388M-DUAL

Extensor HDMI Inalámbrico para **100 m**



## Características

- Señal en **1080P** hasta **100 m**
- Control **IR**
- Soporta conexión **1 TX to 2 RX**
- Soporta conexión **2 TX to 2 RX**
- Máximo 10 pares por área

- **Conexión uno a uno y dos a dos**

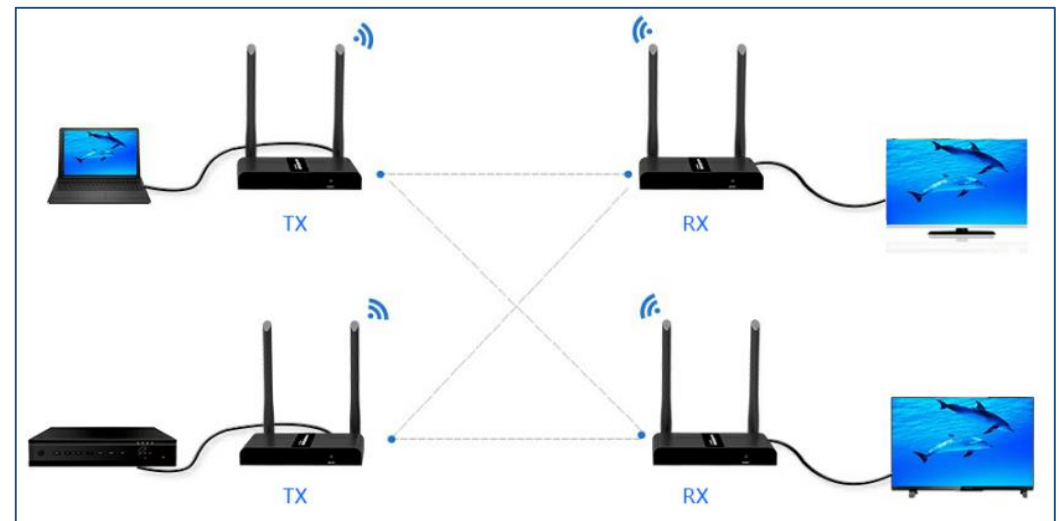



# TT388DM

**15 m** Extensor inalámbrico tipo switch



## Características

- HDMI 1.3
- HDCP1.2
- **1080P** hasta **15 m**
- Switches 10 a 1
- TX requiere fuente de alimentación
- Plug & play

## 15 m Extensor HDMI inalámbrico con switch

- Conexión **Max.10** entradas a 1 salida :

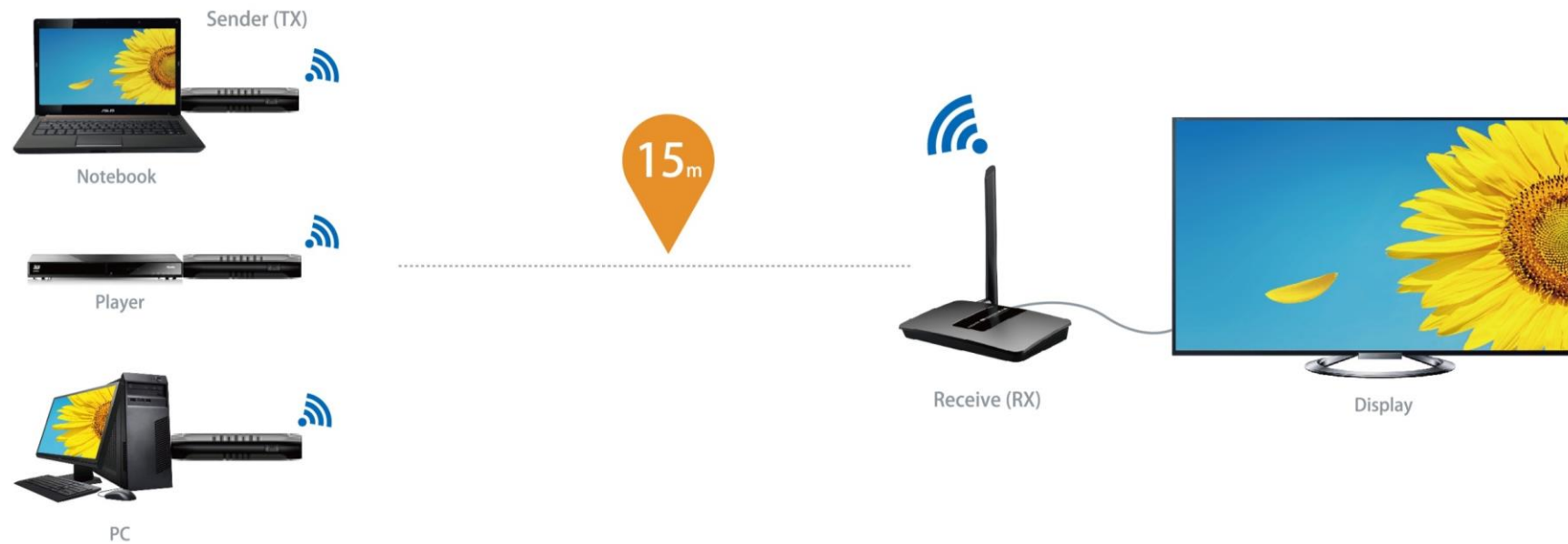

- Aplicación:

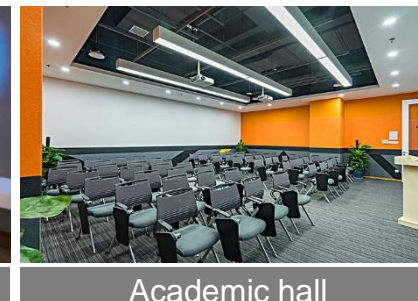
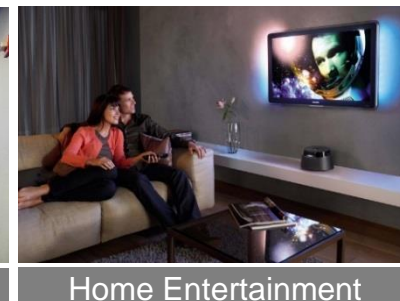

# TT388MINI

**15 m** Mini extensor HDMI inalámbrico

## Características

- Mini extensor para **15M** inalámbrico **1080P**
- Tamaño ultra pequeño
- Alimentación en TX por HDMI, RX por cable USB
- Control **IR**
- Plug & Play



Wireless transmission



Mini design



HDMI / USB port for power



15M



1080P@60Hz



Plug and play



# TT388MINI

15 m Mini extensor HDMI inalámbrico

## ■ Conexión



## ■ Aplicación



Meeting Room



Education



Home Entertainment



Super market

## Divisores HDMI

---

| Modelo No.       | Producto           | Características                                  |
|------------------|--------------------|--|
| TT-312-V2.0      | Divisor 4K 1X2     | HDMI2.0 4K@60Hz Divisor 1X2                      |
| TT-314-PRO       | Divisor 4K 1X4     | 4K@30Hz Divisor 1X4                              |
| TT-318-PRO       | Divisor 4K 1X8     | 4K@30Hz Divisor 1X8                              |
| TT-312HDR-2.0    | Divisor 4K HDR 1X2 | HDMI2.0 4K@60Hz Divisor 1X2, con HDR             |
| TT-314HDR-2.0    | Divisor 4K HDR 1X4 | HDMI2.0 4K@60Hz Divisor 1X4, con HDR             |
| TT-714-PRO       | Divisor HDMI 1X4   | Divisor HDMI 1X4 sobre Cat6 a 40M, con IR        |
| TT-718-PRO       | Divisor HDMI 1X8   | Divisor HDMI 1X8 sobre Cat6 a 40M, con IR        |
| TT-314-4K-HDbitT | Divisor 4K 1X4     | 4K@30Hz Divisor 1X4 sobre Cat5/6 to 120M, con IR |



# TT312-V2.0

## 4K HDMI2.0 Divisor 1 x 2



- HDMI2.0
- HDCP2.2
- UHD 4K @ 60Hz
- Divisor 1X2
- cable HDMI 20 m + 20 m ( Use TT1684K )





# TT314-PRO

## 4K Divisor 1 x 4



- **UHD 4K @ 30Hz**
- **Divisor 1 x 4**
- **Cable HDMI 20 m + 20 m ( Use TT1684K )**

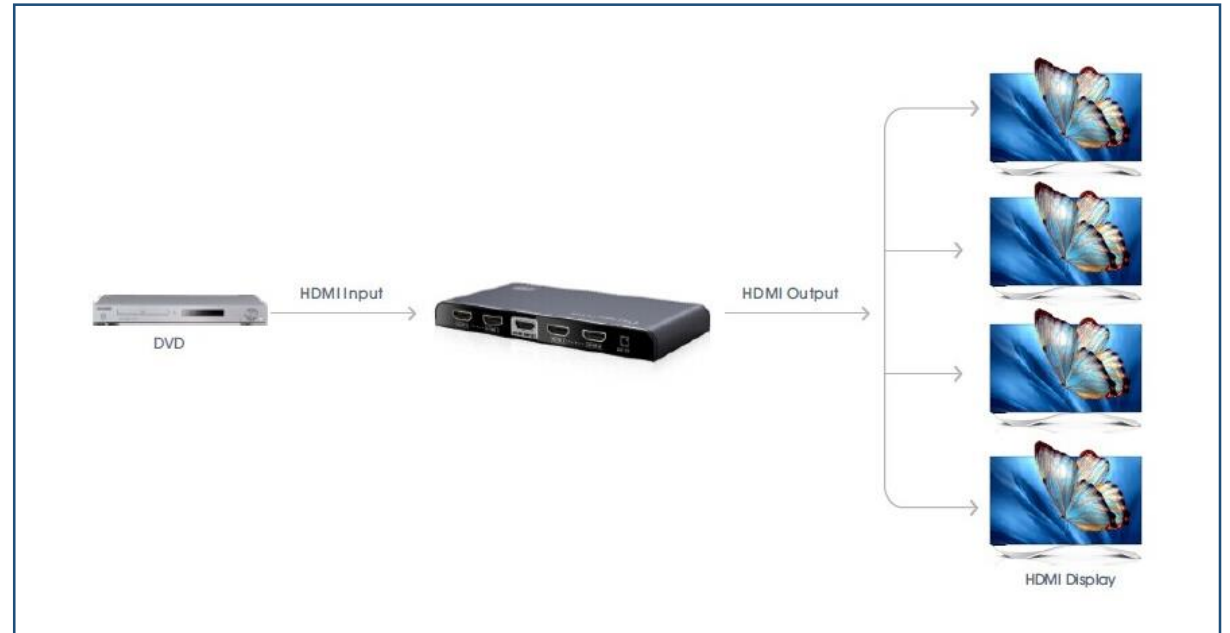

# TT318-PRO

## 4K Divisor 1 x 8



- **UHD 4K @ 30Hz**
- **Divisor 1 x 8**
- **Cable HDMI 20 m + 20 m ( Use TT1684K )**

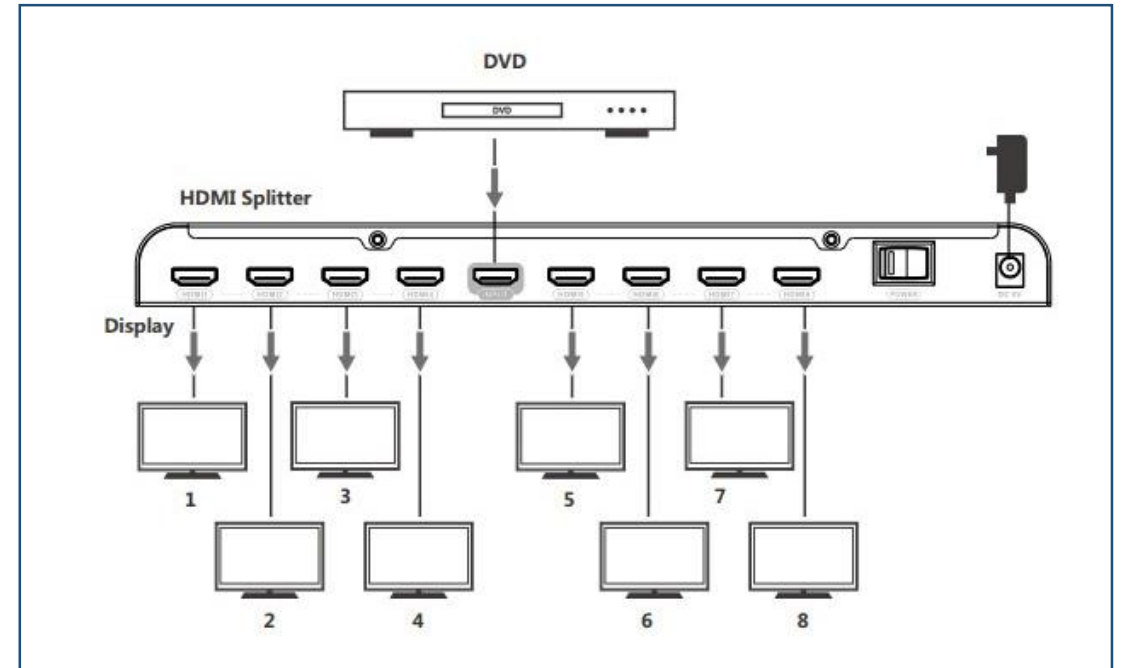

# TT312HDR-2.0

Divisor 1 x 2 **4K** HDMI2.0,HDR



- HDMI 2.0
- HDCP 2.2
- UHD **4K @ 60Hz**
- HDR
- Divisor 1 x 2
- Cable HDMI **20 m + 20 m** ( Use TT1684K )

HDMI 2.0

HDR

4Kx2K@60Hz

Divisor1x2

3D

Plug & Play

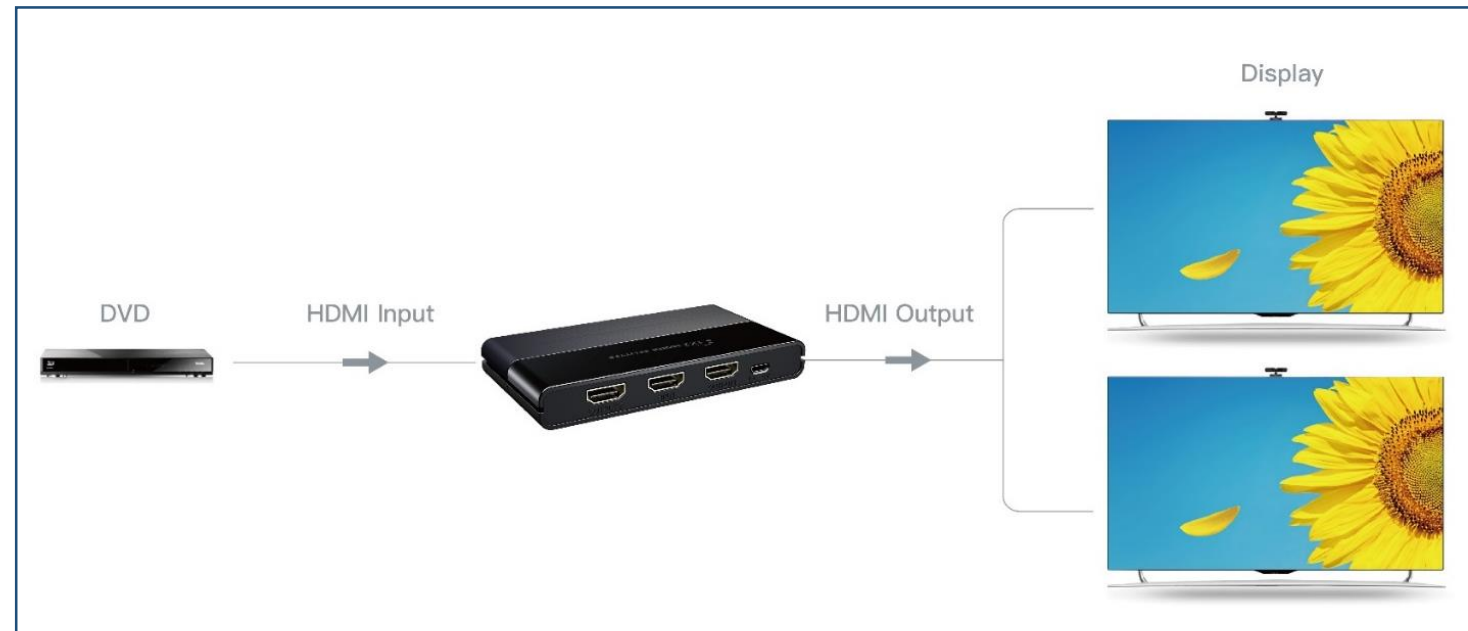

# TT314HDR-2.0

Divisor 1 x 4 **4K** HDMI2.0,HDR



HDMI 2.0

HDR

4Kx2K@60Hz

Divisor 1x4

3D

Plug & Play

- HDMI2.0
- HDCP2.2
- UHD 4K @ 60Hz
- HDR
- Divisor 1X4
- Cable HDMI 20 m + 20 m ( Use TT1684K )

## ■ Conexión

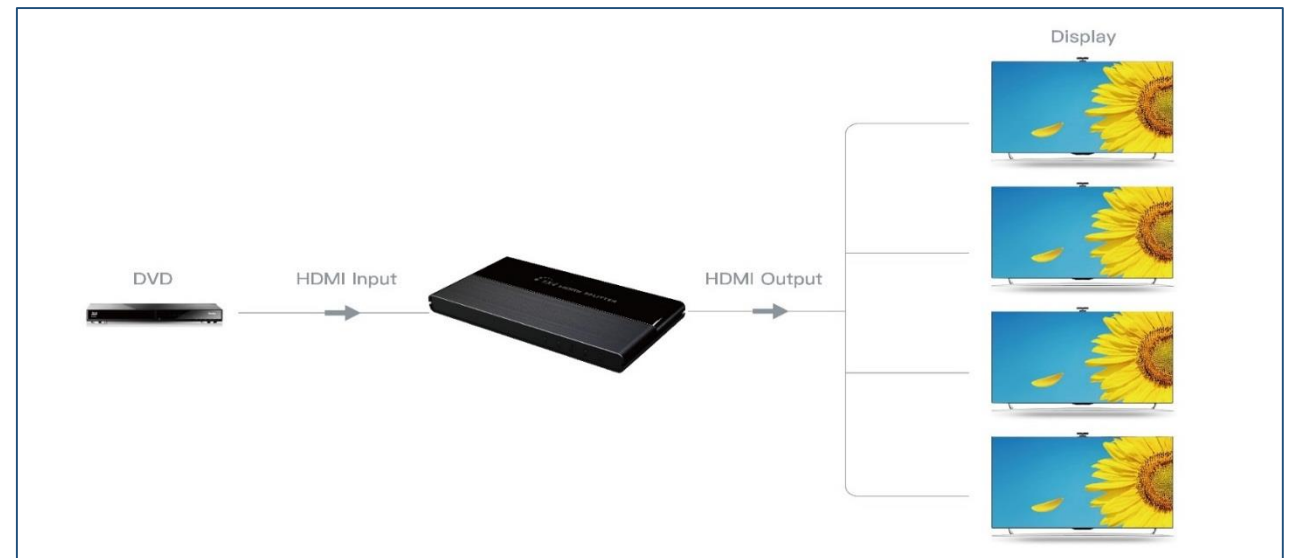

# TT318EDID-V2.0

Divisor 1 x 8 **4K** HDMI2.0



- HDMI2.0
- HDCP2.2
- **UHD 4K @ 60Hz**
- Divisor 1X8
- HDMI cable **20 m + 20 m** ( Use TT1684K )
- Switch EDID

## ■ Conexión

HDMI 2.0

4Kx2K@60Hz

Divisor 1x8

3D

Plug & Play

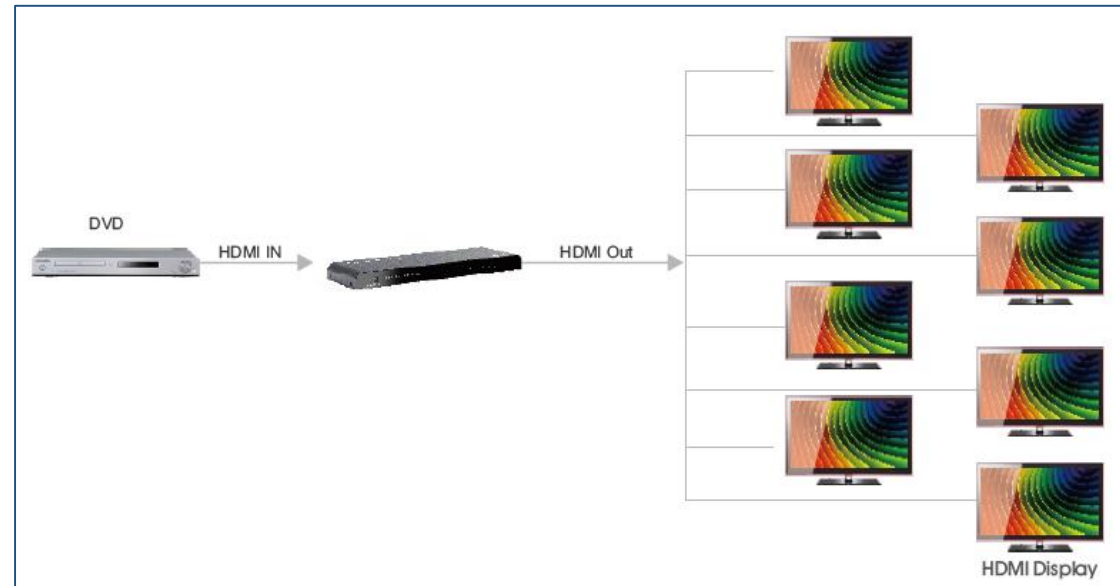

# TT712PRO

HDMI Divisor 1 x 2 sobre Cat6 a **40 m**

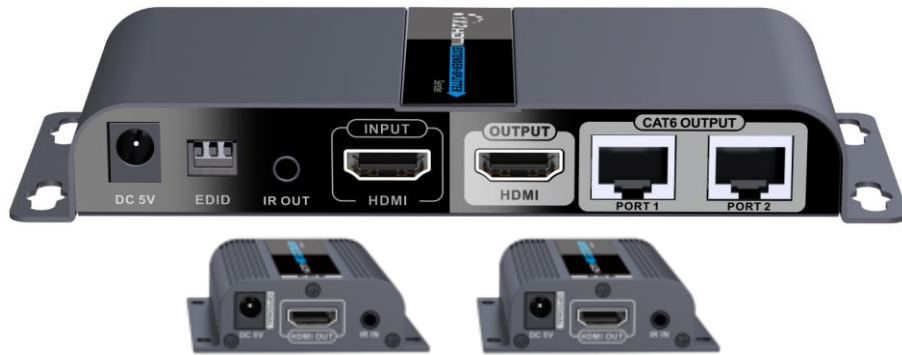

## Características

- Divisor **1080P** 1 x 2
- Sobre CAT6 a **40 m** ( use TT1684K )
- Alimentación – En el transmisor solamente
- HDMI Loop-out  
Control IR

## ■ Conexión

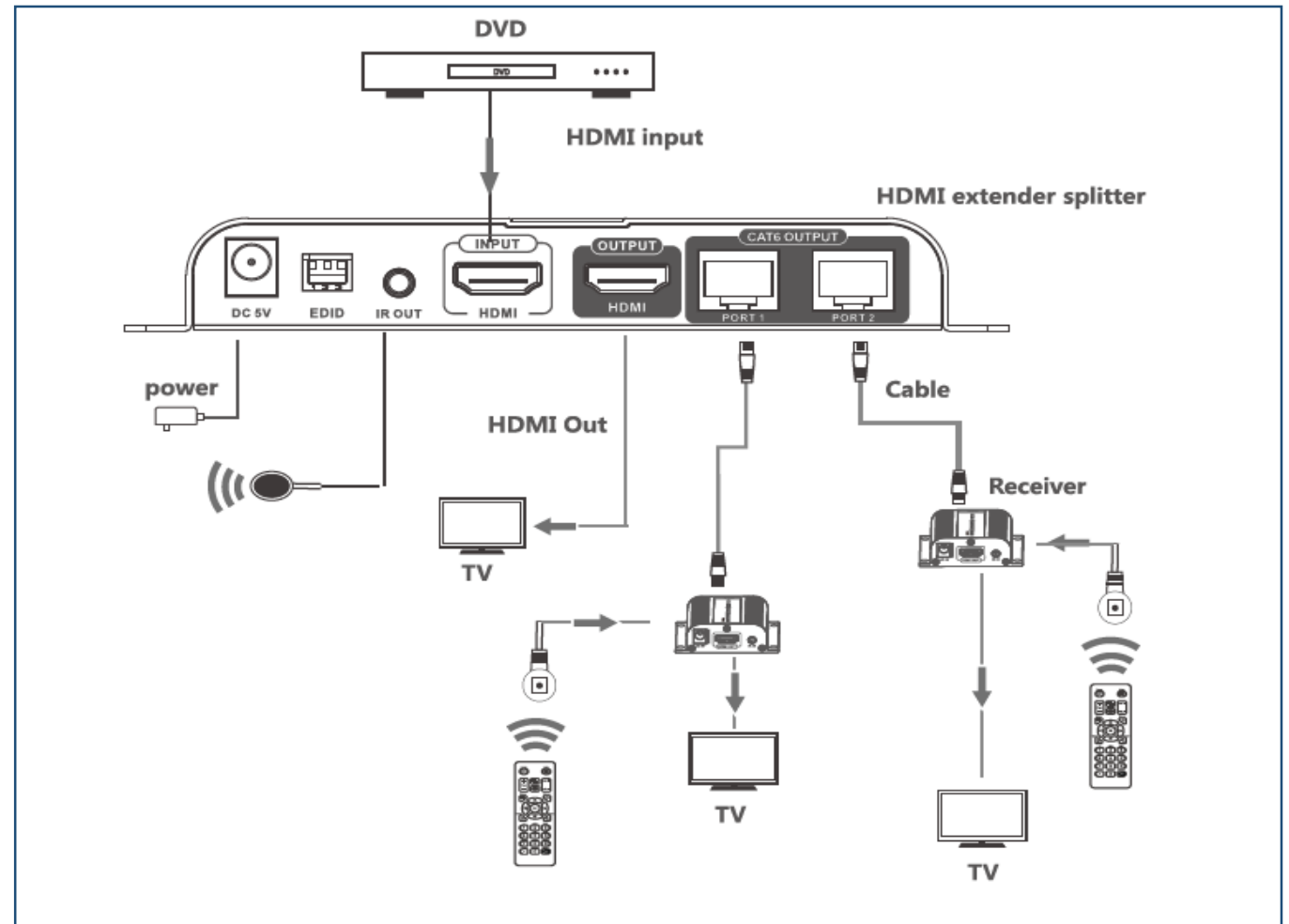

# TT714PRO

Divisor HDMI 1x 4 sobre Cat6 hasta **40M**

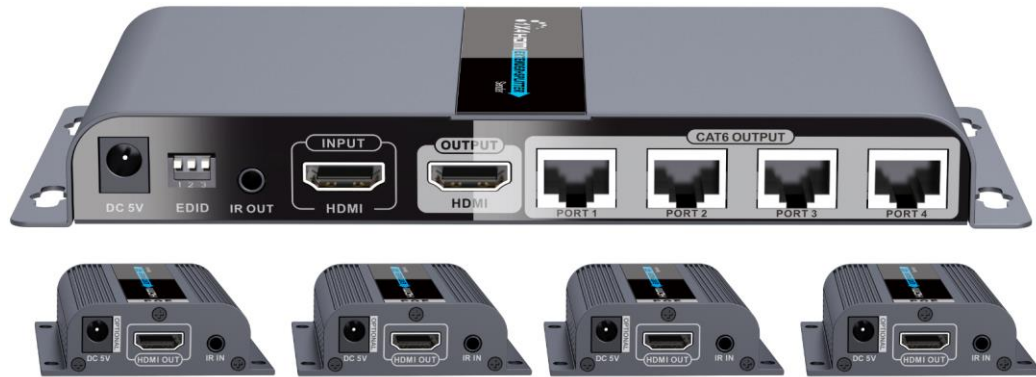

## Características

- Divisor HD **1080P** 1x4
- Sobre UTP CAT6 hasta **40M**
- Alimentación en TX únicamente
- Salida **Loop en HDMI**
- Control **IR**

## ■ Conexión

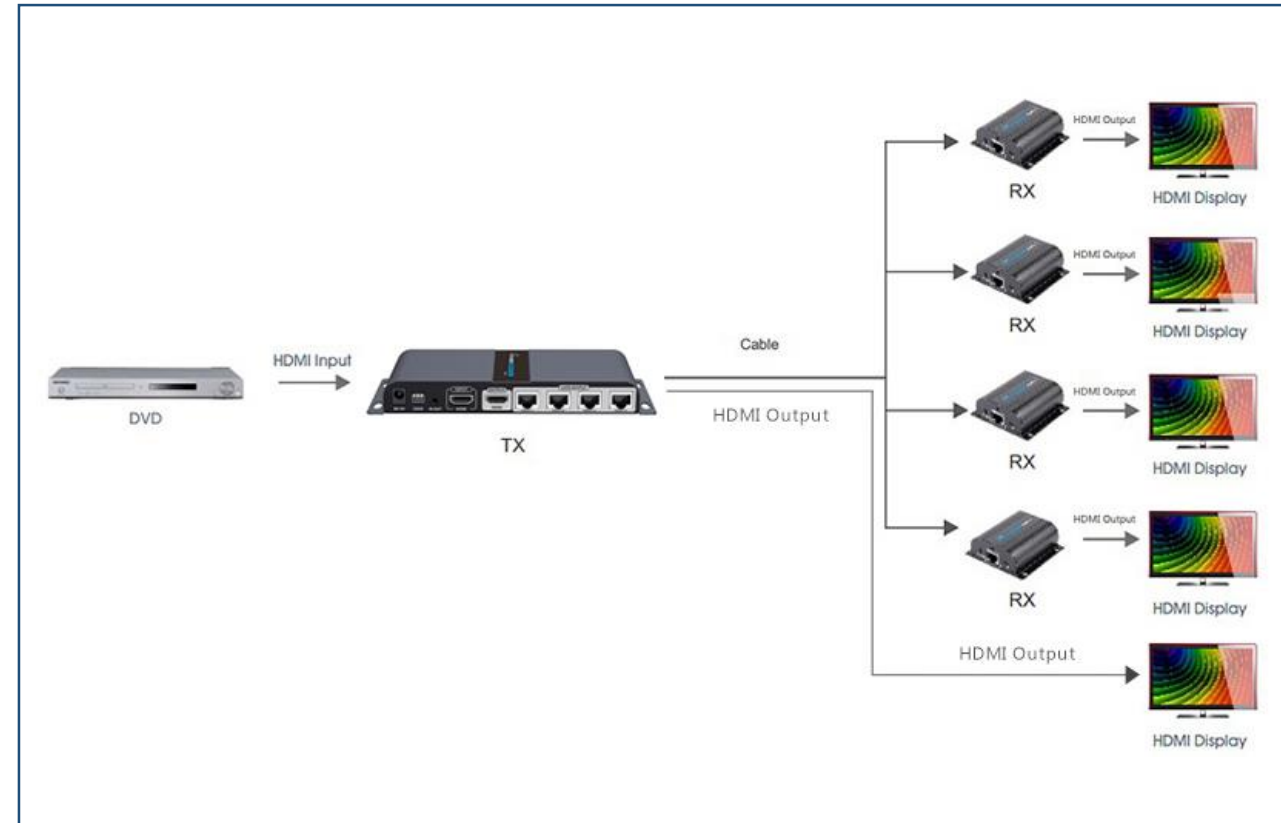



# TT718PRO

Divisor HDMI 1 x 8 sobre Cat6 hasta **40M**

## Conexión



## Características

- Divisor HD **1080P** 1 x 8
- Sobre UTP CAT6 **hasta 40M**
- Alimentación en TX únicamente
- Salida Loop en HDMI
- Control **IR**

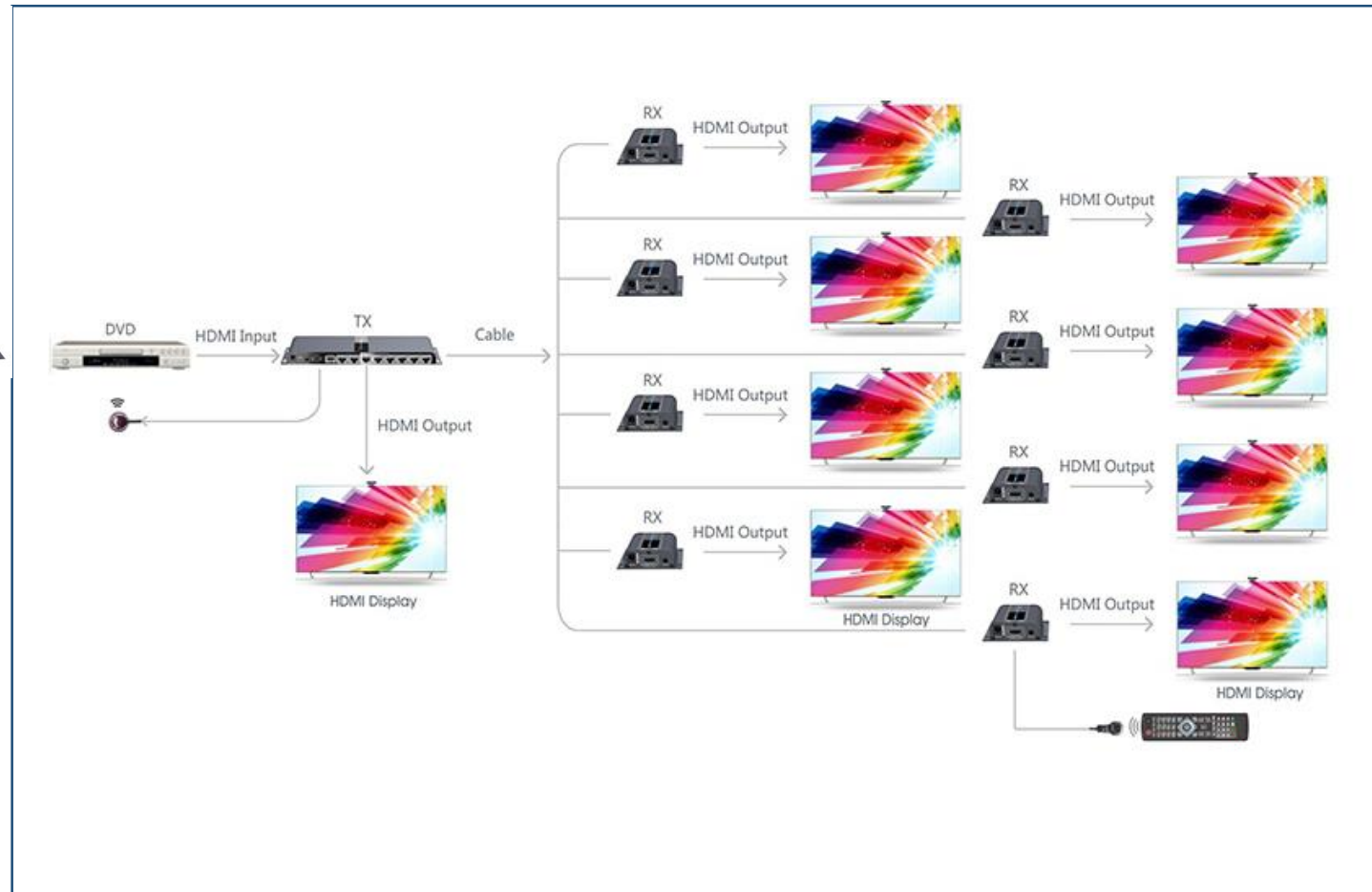



# TT314-4K-HDbitT

Divisor HDMI 1 x 4 sobre Cat5 hasta **120 m**



- Divisor **4K** 1X4
- Sobre CAT5 hasta **120 m**
- Control **IR**

\* Requiere de 4 receptores **TT683RX**

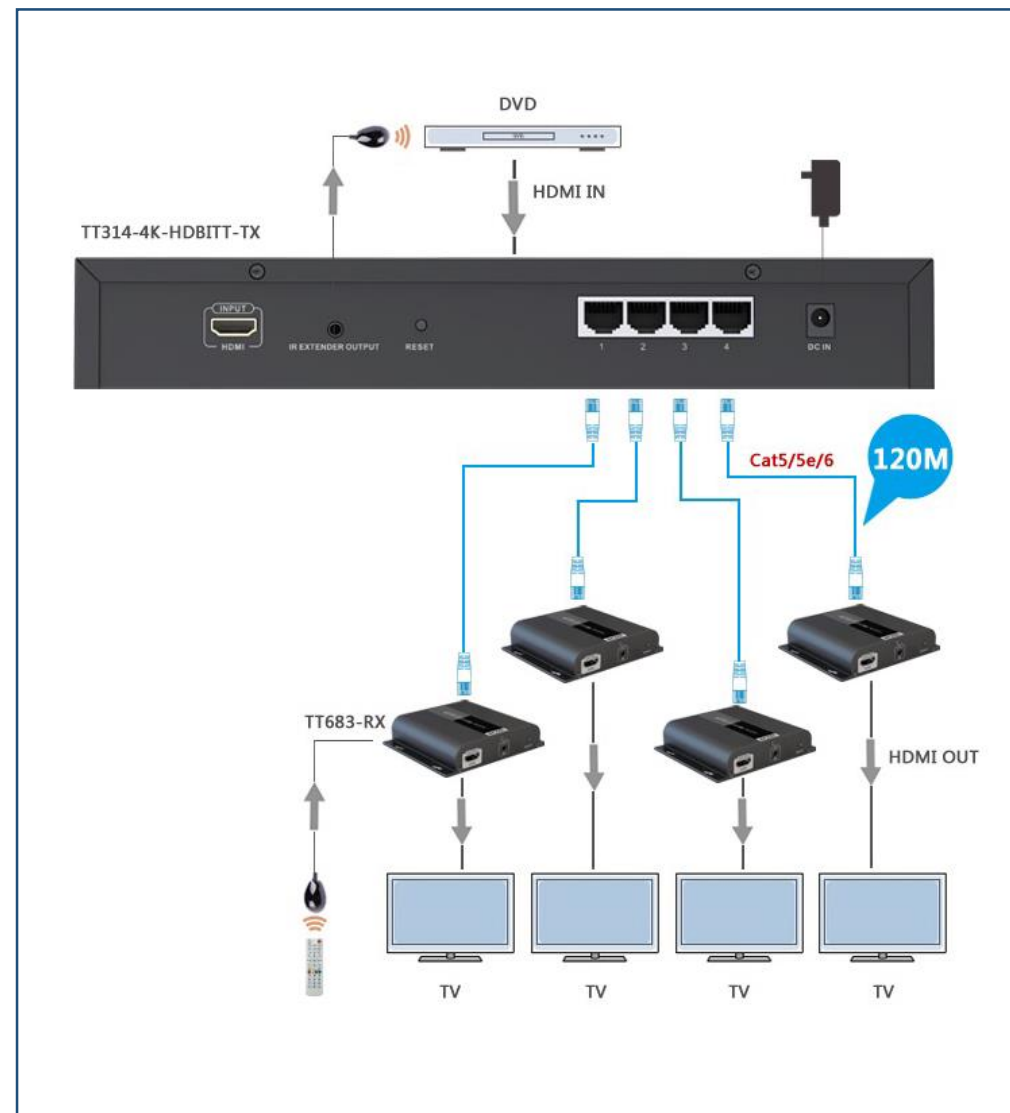

# APLICACIONES

## Kits Divisores, extensores HDMI

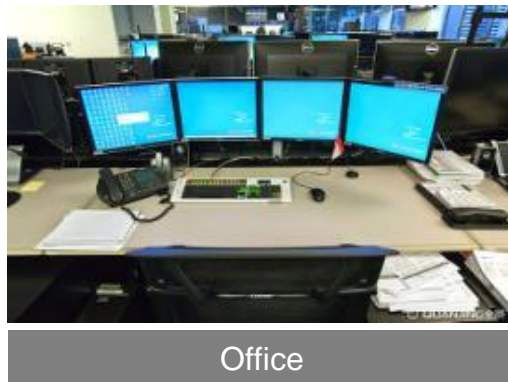
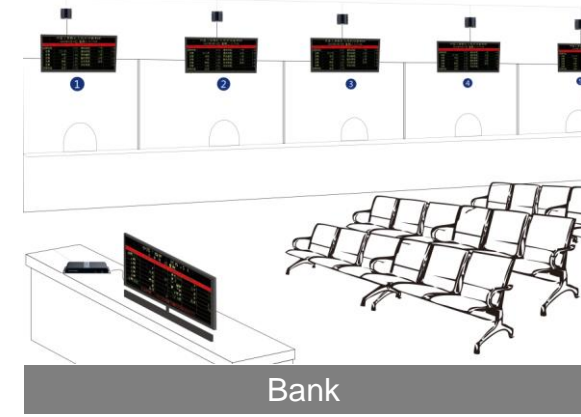

# HDMI Matrix Switch

---

| Modelo           | Producto             | Características  |
|------------------|----------------------|--|
| TT-414           | HDMI Matrix 4X4      | 4K Matrix 4 X 4  |
| TT-818           | HDMI Matrix 8X8      | 4K Matrix 8 X 8  |
| TT-383-MATRIX    | Extensor HDMI Matrix | Full 1080P sobre Cat5/6 hasta 120M/150M, con IR y Matrix |
| TT-383-MATRIX-RX | Receptor HDMI Matrix | Full 1080P sobre Cat5/6 hasta 120M/150M, con IR y Matrix |
| TT-683-MATRIX    | Extensor Matrix 4k   | 4K@30Hz sobre Cat5/6 hasta 120M, con IR and Matrix       |
| TT-683-MATRIX-RX | Receptor Matrix 4K   | 4K@30Hz sobre Cat5/6 hasta 120M, con IR and Matrix       |

# TT383MATRIX

Extensor **1080P** por cable UTP **MATRIX**

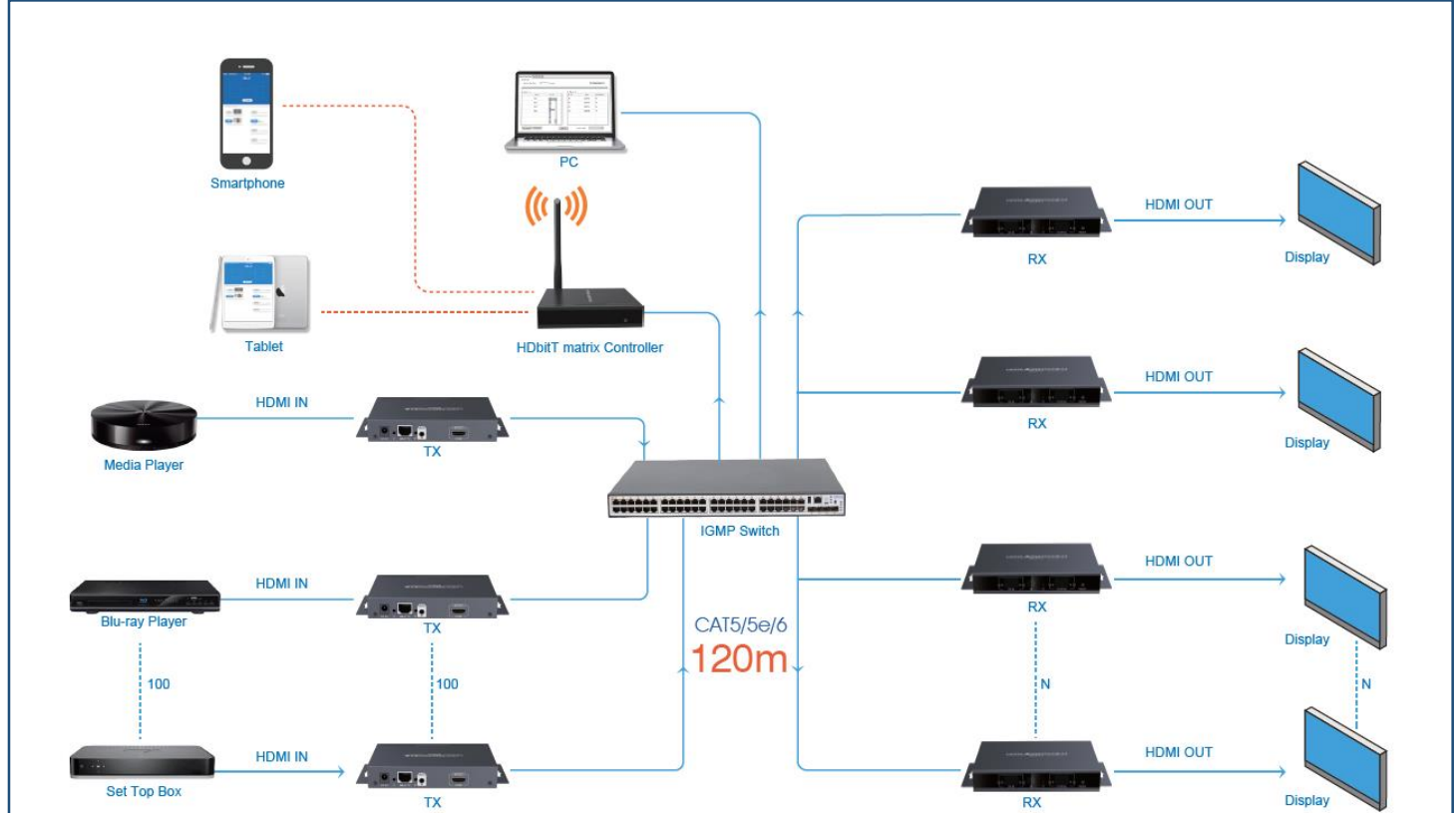

## Various Control Methods

- **1080P** sobre Cat5/6 hasta **120 / 150 m**
- **Máximo 100 canales de entrada**
- **Salidas ilimitadas**
- **Control Remoto, PC, RS232, Botón de control**



APP Control  
(Android, ios, PC)



IR Control  
(20~60KHz IR frequency range)

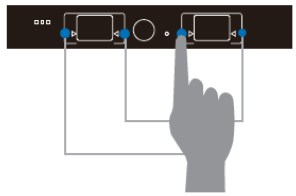

Hard Button Control  
(Select and switch source)

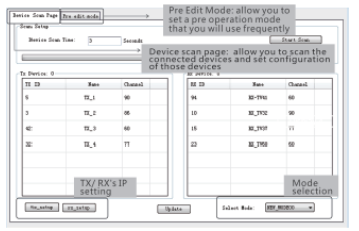

Via Webpage Control  
( Login IP:192.168.2.XXX )

# TT383MATRIX-RX

Receptor **1080P** sobre cable UTP **MATRIX**

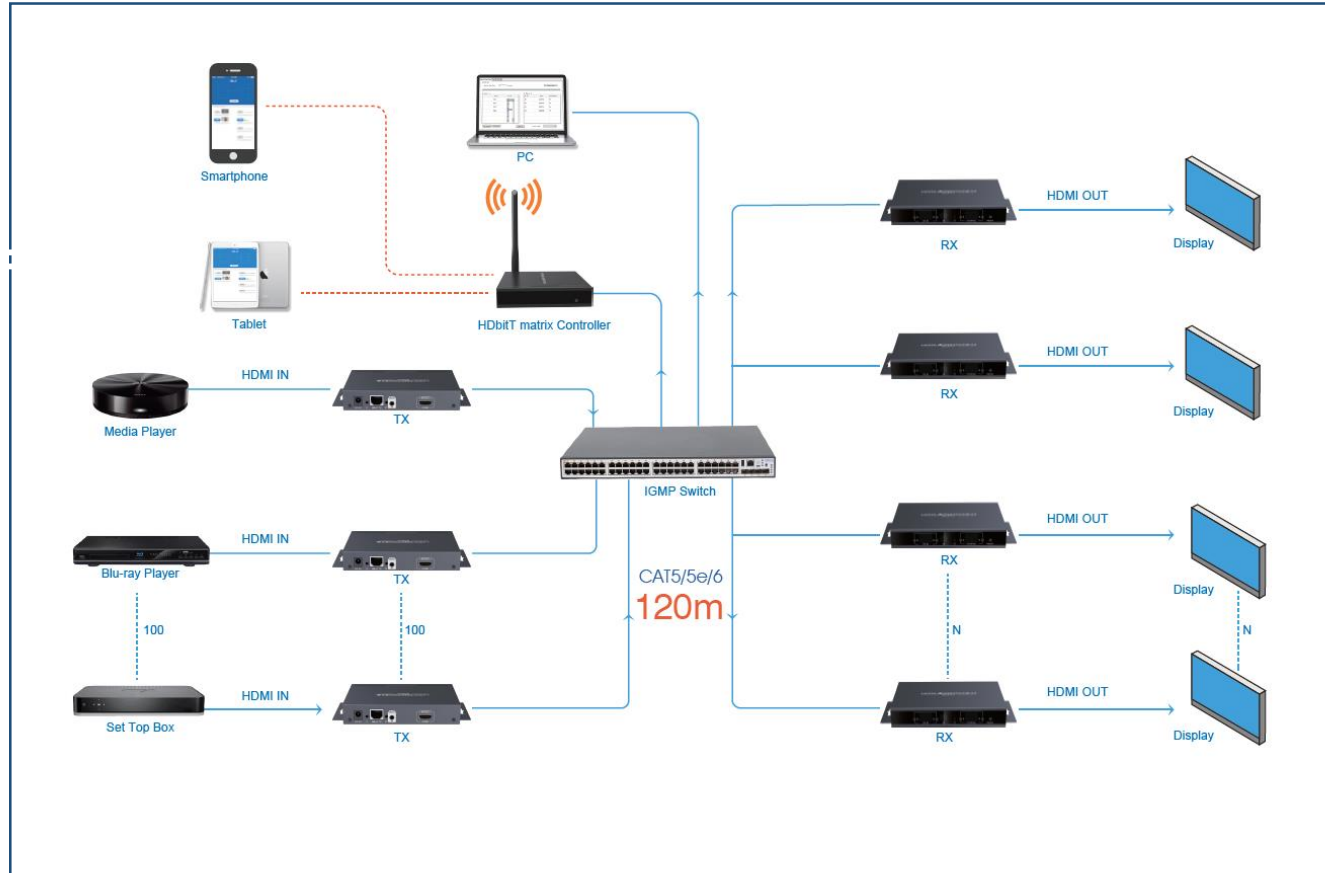

- **1080P** sobre Cat5/6 a **120 / 150 m**
- **Máximo 100 canales de entrada**
- **Salidas ilimitadas**
- **Control Remoto, PC, RS232, Botón de control**

# TT683MATRIX

Extensor **4K** sobre cable UTP **MATRIX**



- **4K** sobre Cat5/6 hasta **120 / 150 m**
- **Máximo 100 canales de entrada**
- **Salidas ilimitadas**
- **Control Remoto, PC, RS232, Botón de control**

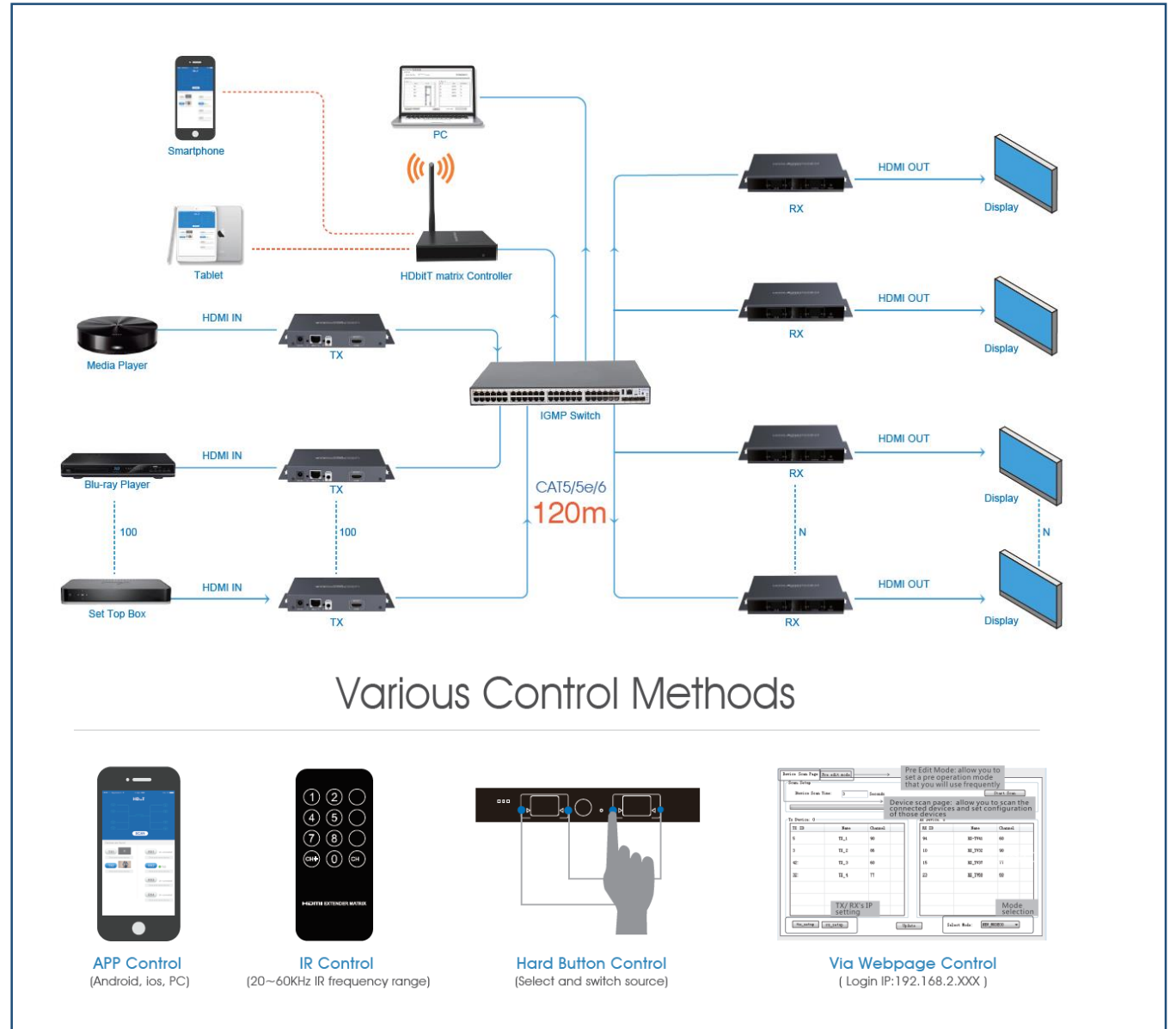



# TT683MATRIX-RX

Receptor **4K** sobre cable UTP **MATRIX**



- **4K** sobre Cat5/6 hasta **120/150 m**
- **Máximo 100 canales de entrada**
- **Salidas ilimitadas**
- **Control Remoto, PC, RS232, Botón de aplicación**

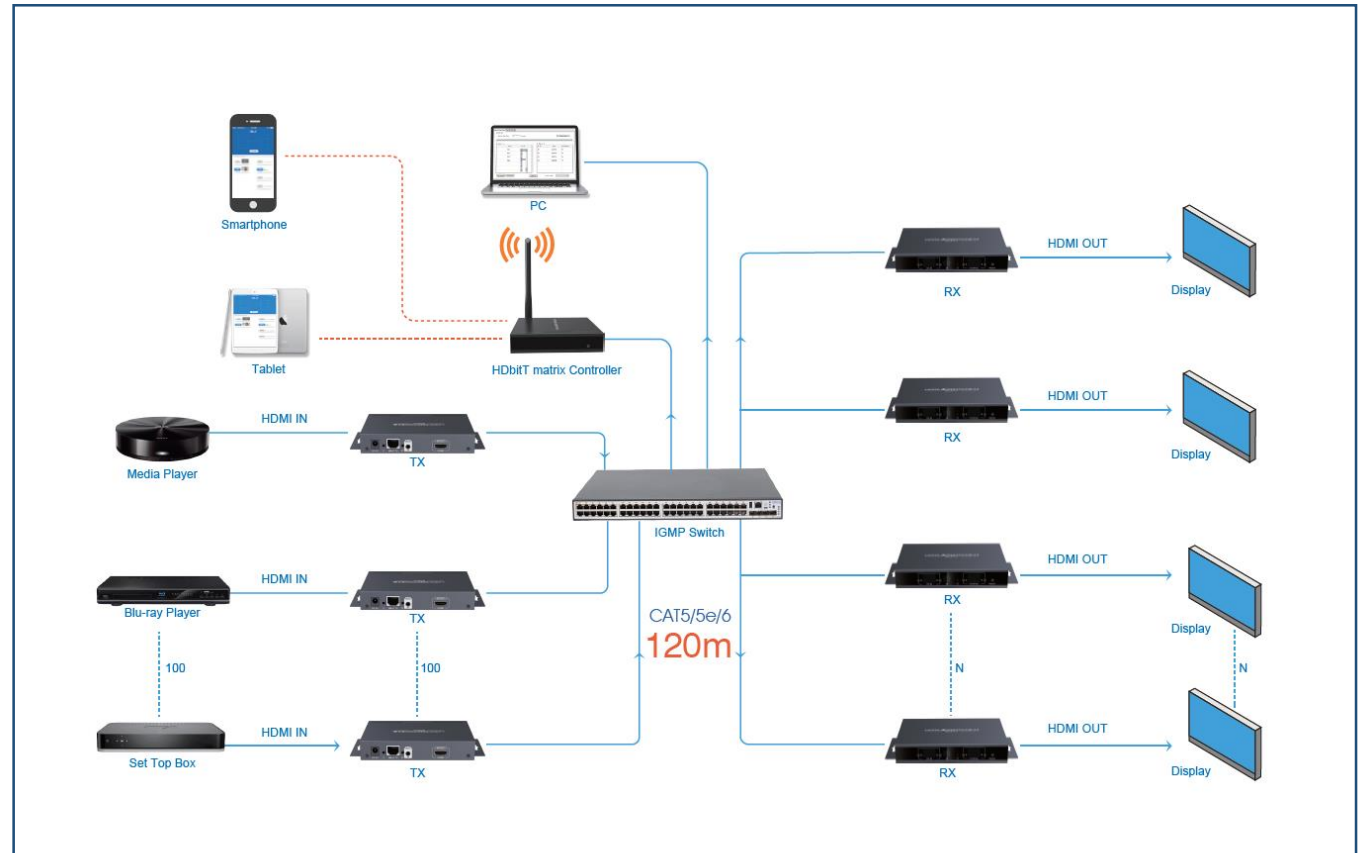

# HDMC001

## Controlador de MATRIX

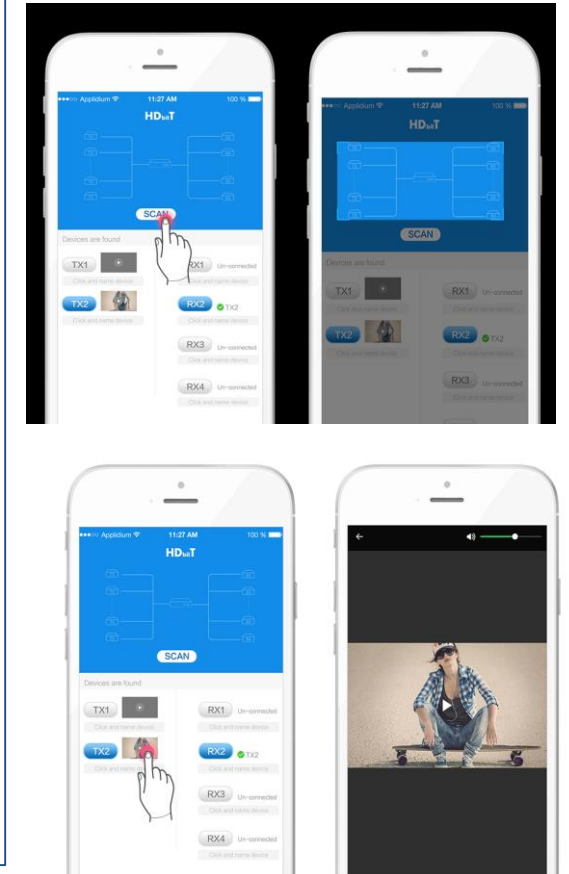
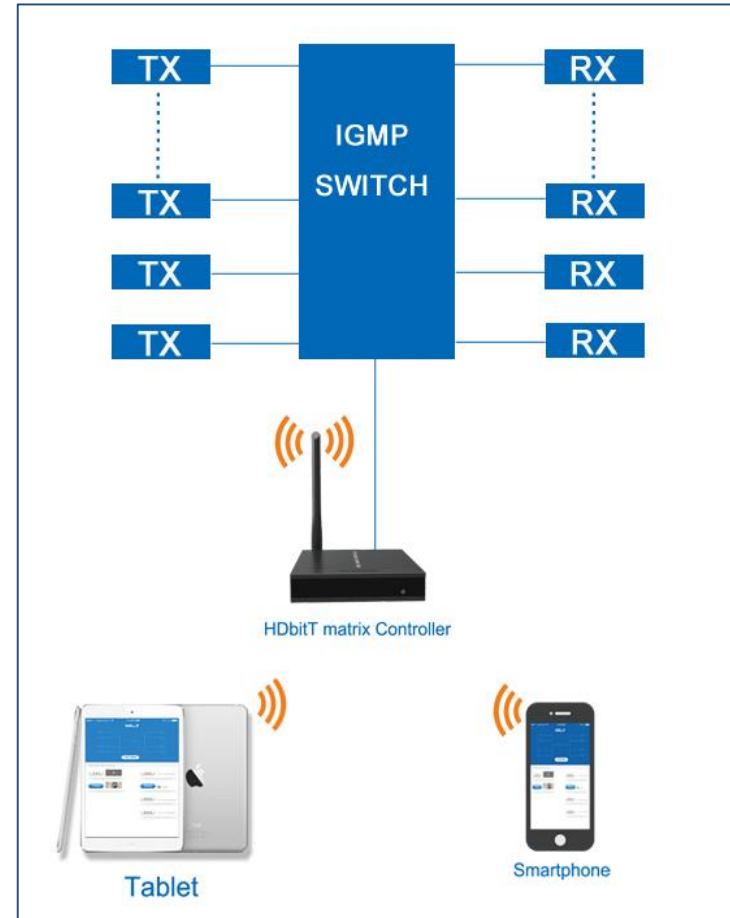







- Controlador inalámbrico de TT383MATRIX y TT683MATRIX
- Aplicación para celular o laptop
- Función de prevista
- ID configurable en TX y RX
- Fácil manejo de canales



# TT414

## Matrix **4K** HDMI Switch 4 x 4



|  |   |   |   |  |  |   |
|--|---|---|---|--|--|---|
| <br>8 input 8 output | <br>4Kx2K@30Hz | <br>YUV4:2:2 | <br>10.2Gbps | <br>HDMI1.4 | <br>HDCP1.4 | <br>3D |
|--|---|---|---|--|--|---|

- 4 entradas HDMI & 4 salidas HDMI @ **40 m** ( Use TT1684K )
- 4K X 2K @30HZ
- YUV : 4: 2: 2
- 3D
- Control Remoto, RS232, Botón de control

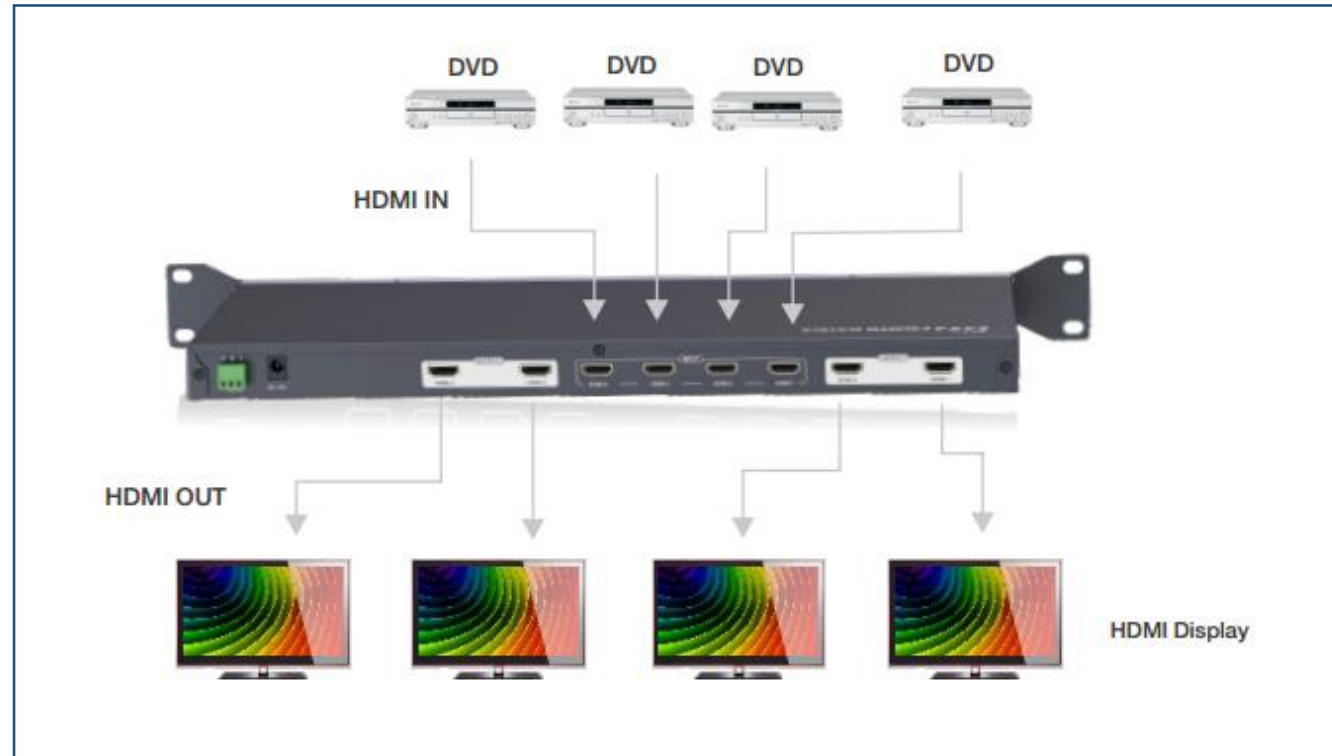

# TT818

## Switch Matrix **4K** HDMI 8 x 8

- 8 entradas HDMI & 8 salidas HDMI **40 m** ( Use TT1684K )
- 4K X 2K @30HZ
- YUV : 4: 2: 2
- 3D
- Control Remoto, RS232, Botón de control

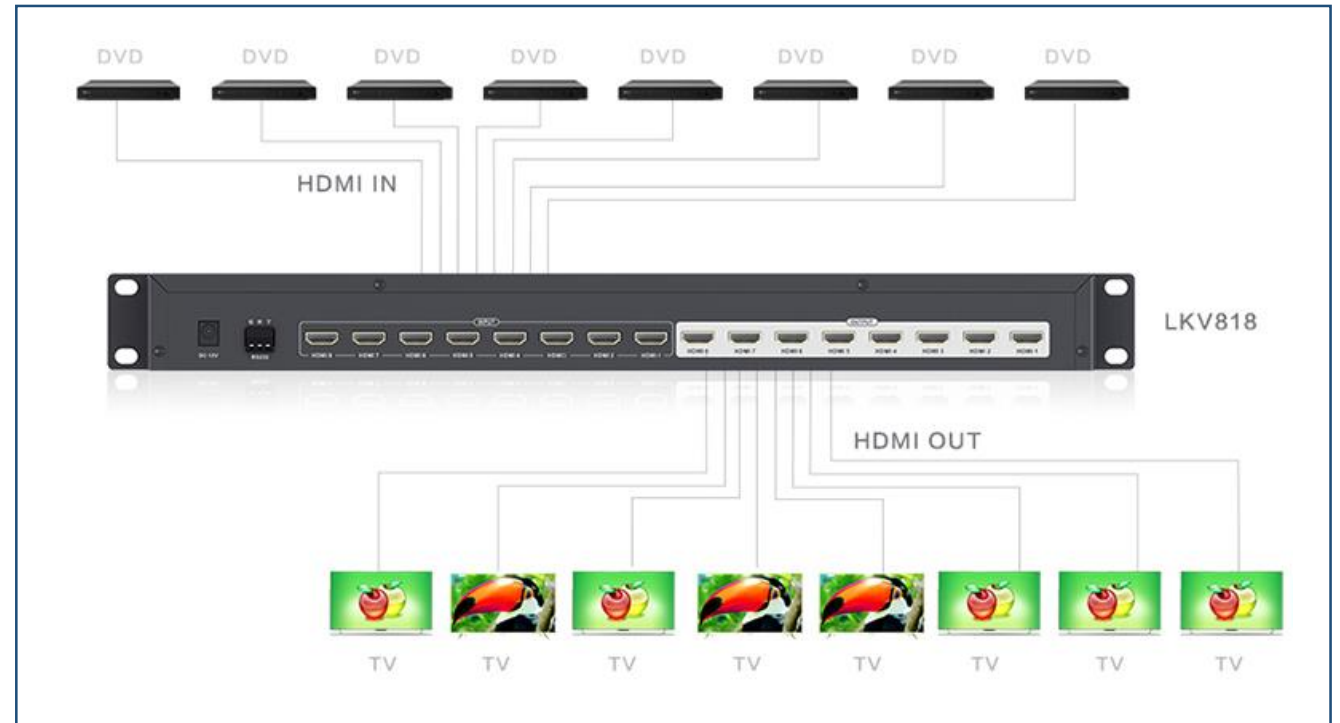
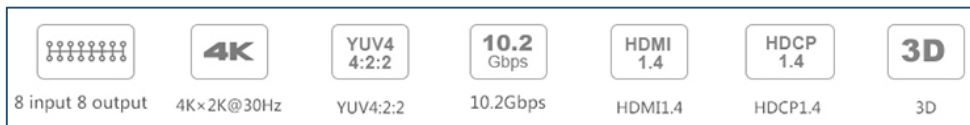

# TT744

HDMI Matrix Switch 4x4, **1080P @ 40 m**



- 4 entradas HDMI x 4 salidas RJ45, 4 salidas HDMI
- **1080P** sobre CAT6 a **40 m** ( use TT1684K )
- Alimentación por el lado del transmisor solamente
- Salida de Loop HDMI en el transmisor



4 in 4 out



Switch freely



1080P@60Hz



3D



RS232



IR Control

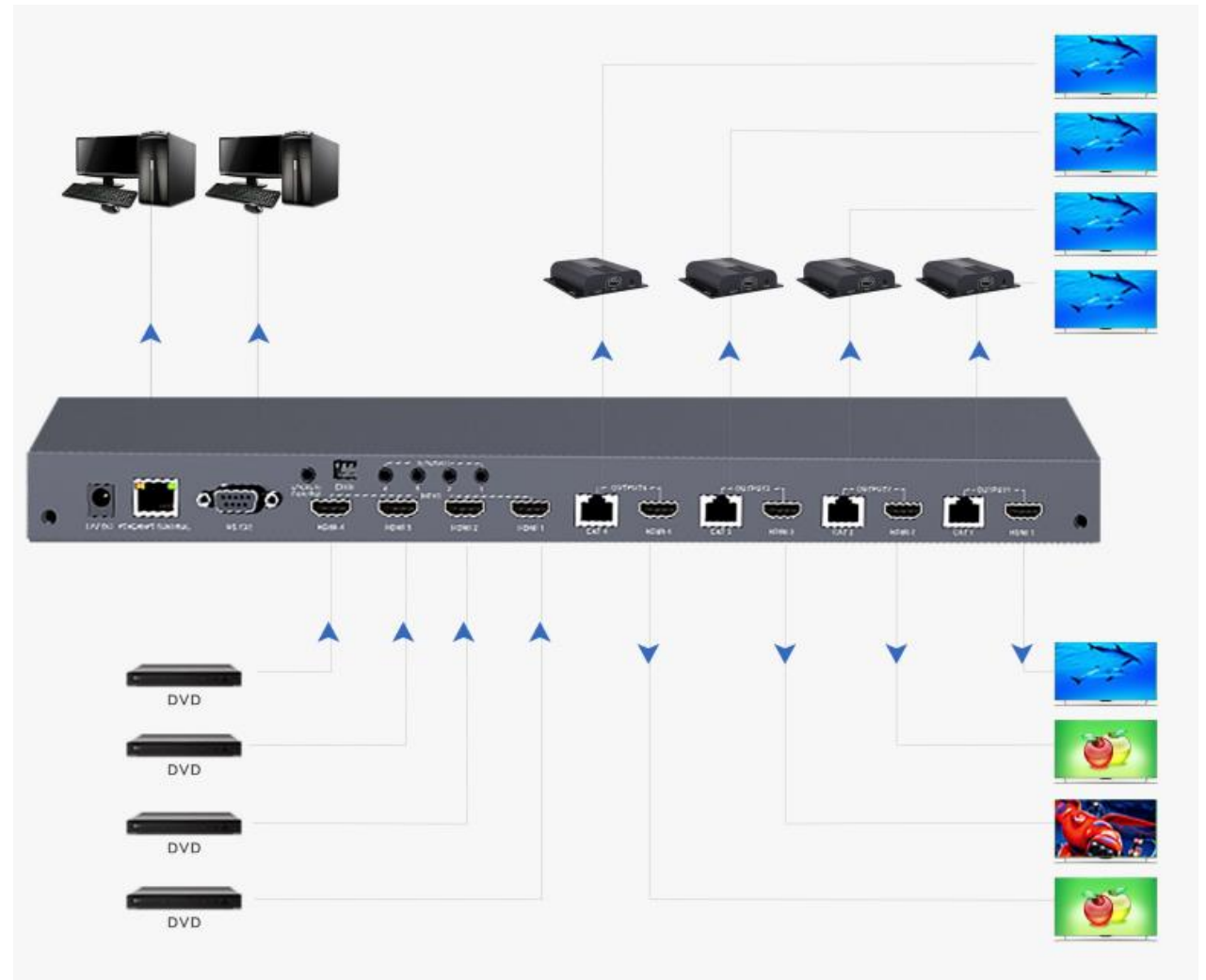

# Switch Multiviewer

---

| Modelo   | Producto               | Características                         |
|----------|------------------------|---|
| TT-401MS | Switch Multivisor HDMI | Switch Multivisor pantalla HDMI en Quad |

# TT401MS

## Switch Multivisor HDMI Quad Screen



Full mode



Dual mode



Quad mode1



Quad mode2



Quad mode3

- Soporta 4 entradas HDMI, 1 salida HDMI
- Soporta modo quad, full screen y dual mode
- Señal HDMI soportada en **1080P@60Hz**
- Soporta modo switch por control remote y botón

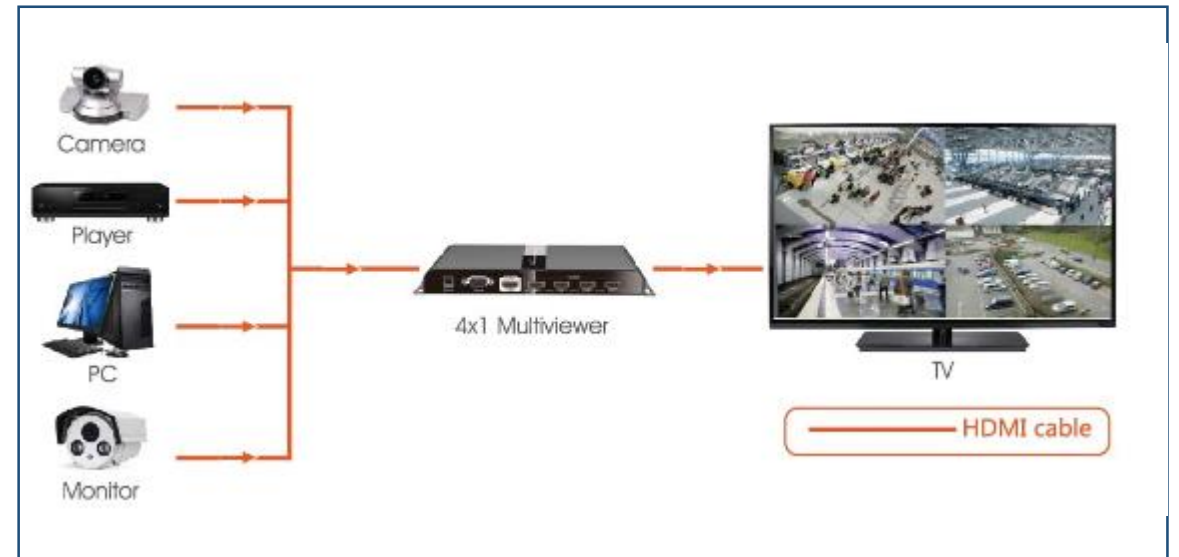

# VideoWall

---

| Modelo    | Producto               | Características                 |
|-----------|------------------------|---------------------------------|
| TT-312-VW | Controlador Video Wall | Controlador Video Wall HDMI 1X2 |
| TT-314-VW | Controlador Video Wall | Controlador Video Wall HDMI 2X2 |

# TT312VW

## Controlador HDMI 1X2 Video Wall



- Video wall controller 1 x 2
- **1080P @ 60 Hz.**
- Soporta division de video wall y el modo de clonación de pantalla.
- Puerto de salida de audio de 3.5mm

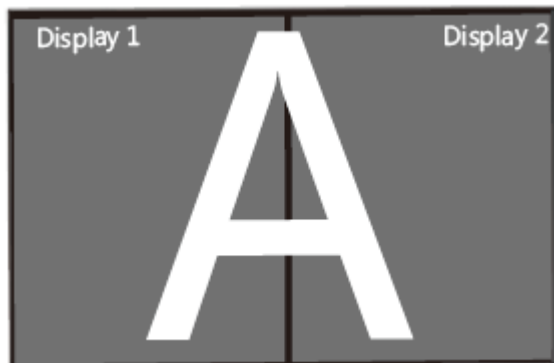

Video Wall Screen Mode

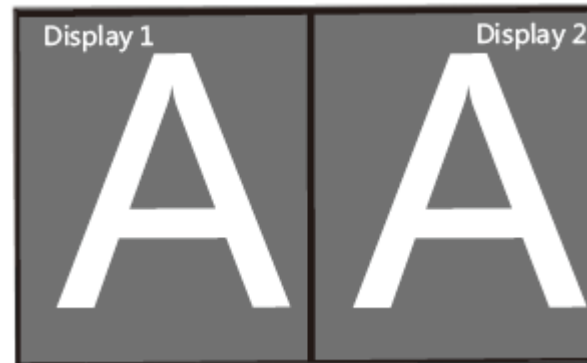

Clonac Screen Mocde

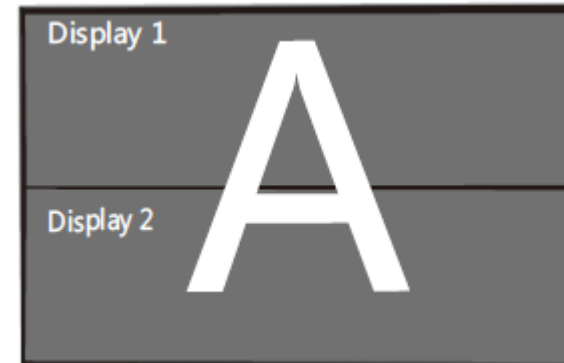

Video Wall Screen Mode

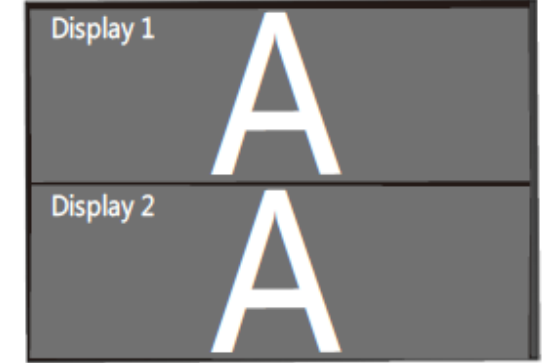

Clonac Screen Mocde



# TT314VW

## Controlador de video wall HDMI 2 x 2



- 4 Salidas HDMI outputs dividen la señal de entrada en cuatro y extiende las imágenes en 4 partes iguales.
- Resolución de **1080P @ 60 Hz.**
- Soporta modo de pantalla video wall y modo clon.
- Entrada de audio en 3.5mm.

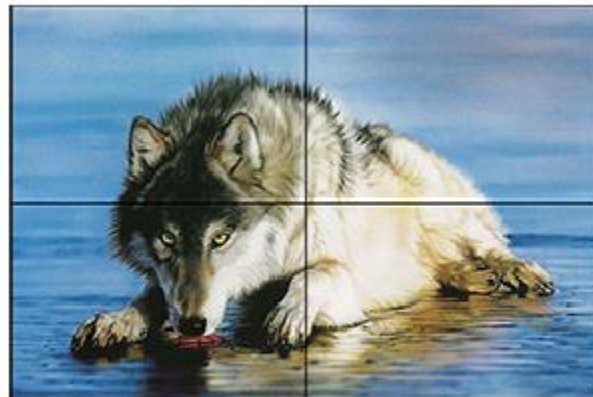

Full Mode



Clone Mode



# Video Switch

---

| Modelo      | Producto      | Características          |
|-------------|---------------|--------------------------|
| TT-501-V2.0 | Switch 4K 5X1 | Switch HDMI2.0 4K en 5X1 |

# TT501-V2.0

## Switch **4K** HDMI 5X1



- HDMI2.0
- HDCP2.2
- UHD **4K @ 60Hz**
- Switch 5X1
- cable HDMI **20 m + 20 m** ( use TT1684K )



# Convertidores

---

| Modelo      | Producto                  | Características             |
|-------------|---------------------------|-----------------------------|
| TT-350-MINI | Convertidor VGA a HDMI    | Convertidor Mini VGA a HDMI |
| TT-352-4K   | Convertidor 4K VGA a HDMI | Convertidor 4K VGA a HDMI   |
| TT-366      | Convertidor BNC a HDMI    | Convertidor BNC a HDMI      |
| TT-7505     | Convertidor BNC a VGA     | Convertidor BNC a VGA       |

# TT350MINI

## Convertidor VGA a HDMI

---



- VGA a HDMI
- **1080P @ 60Hz**
- Plug & Play



# TT352N

## VGA to HDMI Converter

---



- VGA to HDMI
- **1080P @ 60 Hz**
- Plug & Play



# TT352-4K

## Convertidor VGA a **4K** HDMI



- VGA a HDMI 4K
- **4K @ 60 Hz**
- Soporta HDMI 2.0
- Plug & Play

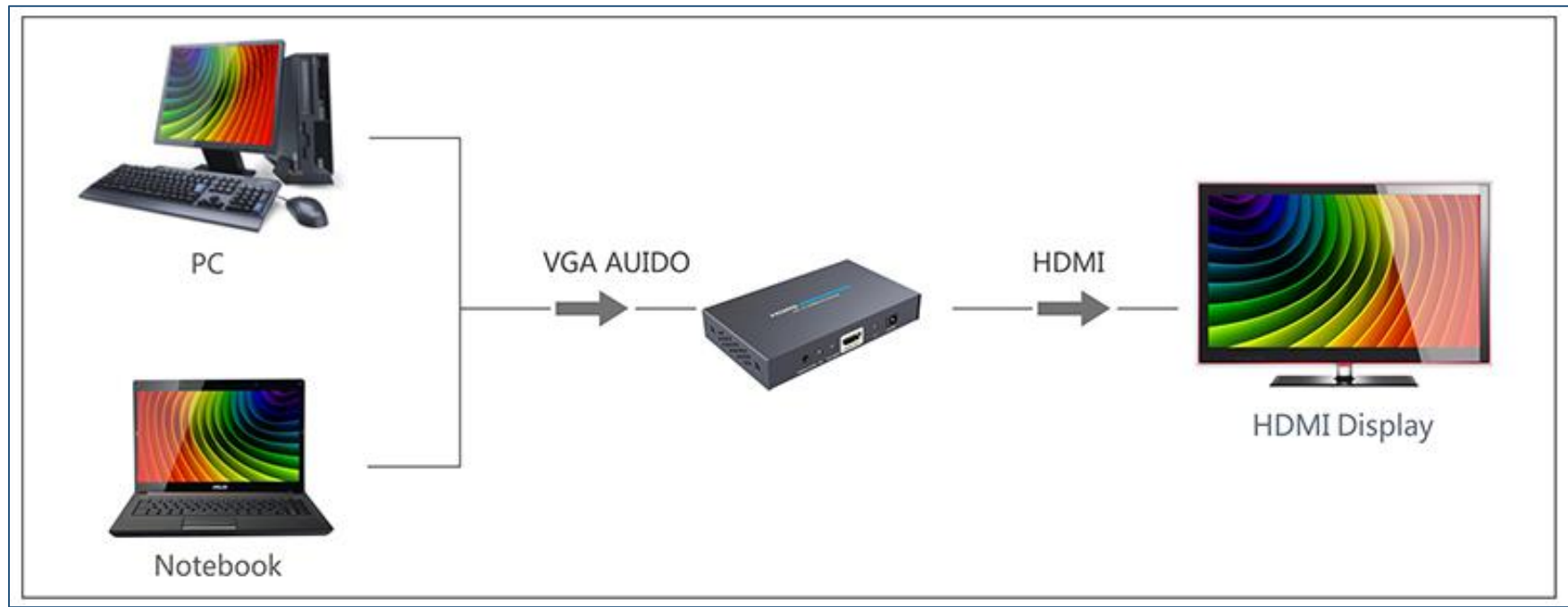

# TT366

## Convertidor BNC a HDMI



- BNC a HDMI
- Soporta salidas **720P/1080P**
- Plug & Play

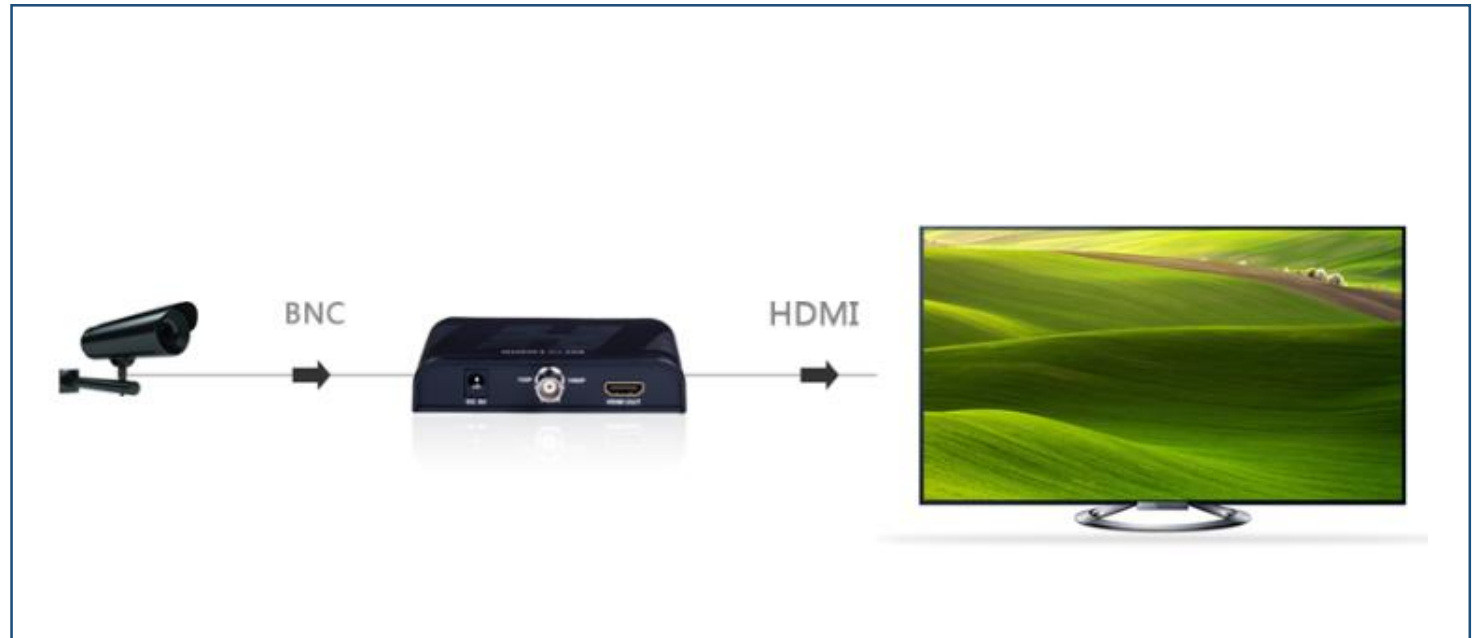



# TT7505

## Convertidor BNC & S-Video a VGA



- BNC & S-Video to VGA
- Soporta salida a **720P/1080P**
- *Plug & Play*

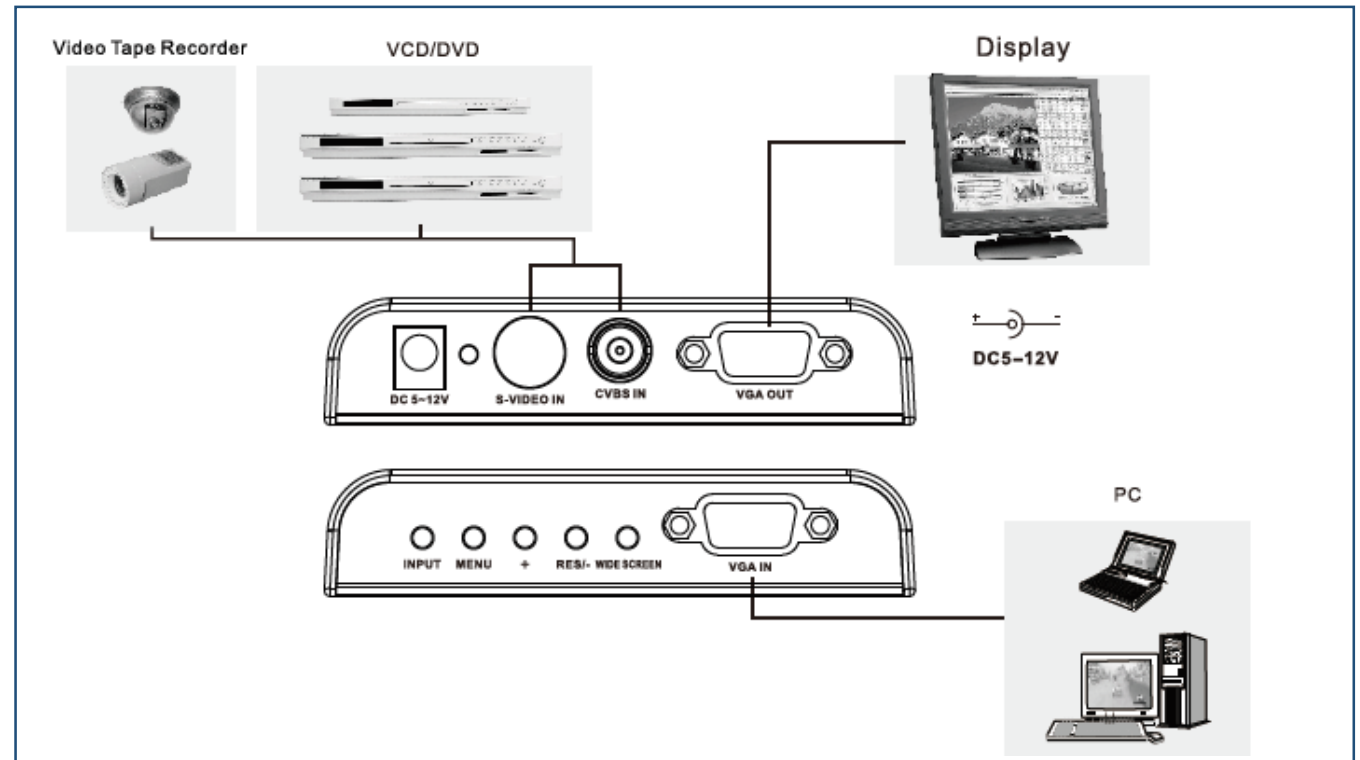

# TT3061

## HDMI2.0 Audio Extractor



- Extractor de Audio
- Soporta HDMI 2.0, **4K @ 60Hz**
- HDCP 2.2 y HDMI1.4
- Soporta HDR
- Soporta ARC

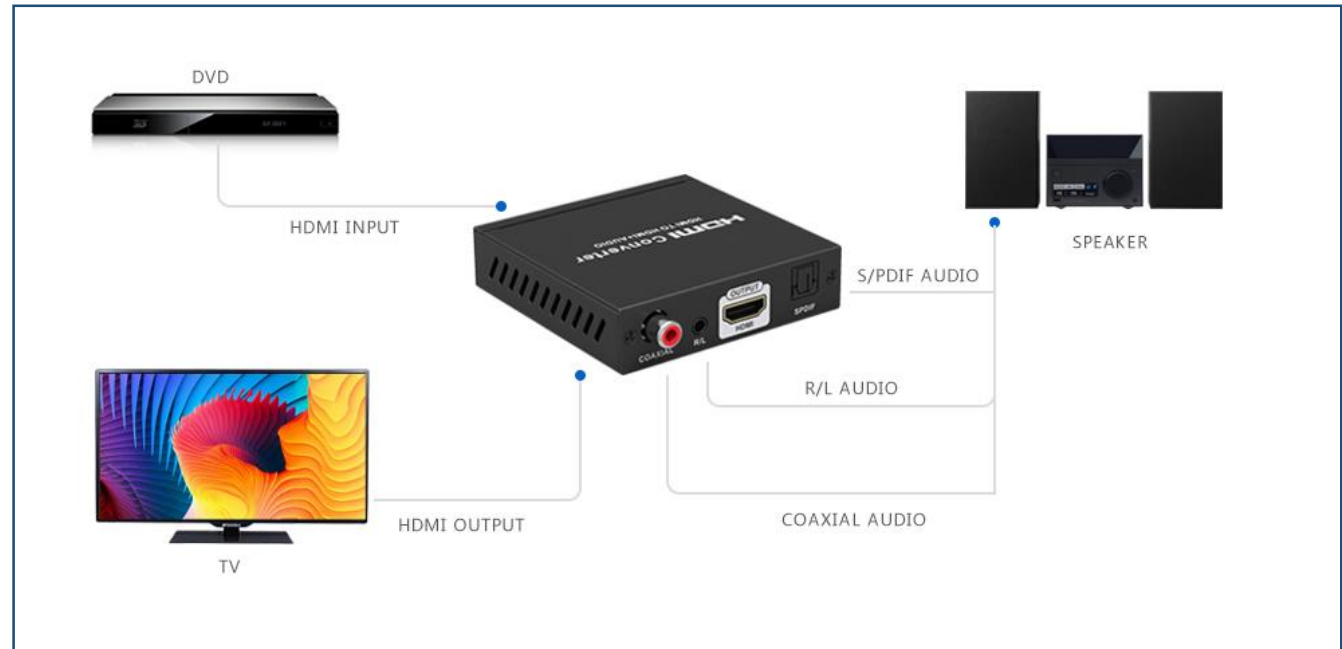

# Extensor Repetidor HDMI

---

| Modelo    | Producto       | Características         |
|-----------|----------------|-------------------------|
| TT-168-4K | Repetidor HDMI | Repetidor HDMI Extensor |

# TT168-4K

## Repetidor Extensor 4K HDMI2.0



### Características

- Soporta **4X @ 60Hz**
- **HDMI 2.0**
- **HDCP 2.2**
- Alimentación de 5 Vcd
- Plug & Play

### Conexión

HDMI 2.0   Repetidor   4K   HDCP 2.2



[WWW.SYSCOM.MX](http://WWW.SYSCOM.MX)