

# **Compass 2.0**

## **User's Guide**

Document ID

R2.0

07/10

### **Release 2.0**

#### **Honeywell**

This work contains valuable, confidential, and proprietary information. Disclosure, use or reproduction outside of Honeywell Inc. is prohibited except as authorized in writing. This unpublished work is protected by the laws of the United States and other countries.

# Notices and Trademarks

**Copyright 2009 by Honeywell International Inc.  
Release 2.0. July 2010**

While this information is presented in good faith and believed to be accurate, Honeywell disclaims the implied warranties of merchantability and fitness for a particular purpose and makes no express warranties except as may be stated in its written agreement with and for its customers.

In no event is Honeywell liable to anyone for any indirect, special or consequential damages. The information and specifications in this document are subject to change without notice.

Honeywell Security and  
Custom Electronics  
2 Corporate Center Drive  
Melville, NY, 11747, USA  
**1-516-921-6704**

# About This Document

## Revision Notes

The following list provides notes concerning all revisions of this document.

## References

Doc ID	Rel ID	Date	Notes
None	DRAFT	Aug 2005	Draft version of Compass 2.0 User Guide
	Rel 2.0	Nov 2008	Version 2.0 of Compass 2.0 User Guide
		September 2009	Updates to the Compass 2.0 User's Guide
		July 2010	Updated the user guide with features of 2.0.14

The following list identifies all documents that may be sources of reference for material discussed in this publication.

Document Title	Doc ID
Compass Downloading Software (16-bit) User Guide	None

## Contacts

### World Wide Web

The following Honeywell web sites may be of interest to Industry Solutions customers.

Honeywell Organization	WWW Address (URL)
Corporate	<a href="http://www.honeywell.com">http://www.honeywell.com</a>
Security & Custom Electronics	<a href="http://www.security.honeywell.com/">http://www.security.honeywell.com/</a>
International	<a href="http://content.honeywell.com/global/">http://content.honeywell.com/global/</a>

### Telephone

Contact us by telephone at the numbers listed below.

	Organization	Phone Number
Canada	Honeywell Security and Custom Electronics, Canada	905-856-2384 or 1-800-259-9182
Latin America	Honeywell Security International Latin American and Caribbean Division	1-305-805-8188

Asia Pacific	Honeywell Asia Pacific Inc. Hong Kong	+852-2405-2323
Europe	Honeywell Security The Netherlands	+31 299 410 200





For more contact information see <http://www.security.honeywell.com/international>

### Technical Support

For any technical assistance related to Compass 2.0 please address your queries to [compass.support@honeywell.com](mailto:compass.support@honeywell.com)

## Symbol Definitions

The following table lists those symbols used in this document to denote certain conditions.

Symbol	Definition
	<b>ATTENTION:</b> Identifies information that requires special consideration.
	<b>TIP:</b> Identifies advice or hints for the user, often in terms of performing a task.
	<b>REFERENCE-EXTERNAL:</b> Identifies an additional source of information outside of this document.
	<b>REFERENCE- INTERNAL:</b> Identifies an additional source of information within this document.

---

# LIST OF CONTENTS

## 1. Introduction

<b>Compass 2.0 Overview .....</b>	<b>1-1</b>
Downloader Program Structure .....	1-1
<b>System / Software Requirements .....</b>	<b>1-2</b>
<b>Viewing Product and System Information.....</b>	<b>1-4</b>
<b>Viewing a List of Panels Supported by Compass 2.0 .....</b>	<b>1-5</b>
<b>Getting Product Updates .....</b>	<b>1-7</b>
Latest Build and Patch Information .....	1-7

## 2. Communications Setup

<b>Setting up Downloader Communications.....</b>	<b>1-8</b>
<b>Setting up the Modem .....</b>	<b>1-8</b>
FBII F7702 Interface .....	1-11
Adding Modems .....	1-12
Editing Modems.....	1-13
Deleting Modems.....	1-14
<b>Configuring Modem Switch Settings.....</b>	<b>1-14</b>
Hayes Smartmodem 1200 External Modem.....	1-15
Hayes Smartmodem 1200(B) Internal Modem.....	1-15
<b>Mapping Devices to IP .....</b>	<b>1-16</b>
<b>Configuring Station Data.....</b>	<b>1-17</b>
Central Station ID .....	1-17
Configuring CSID.....	1-17
Changing the CSID.....	1-19
Customizing User-Defined Fields .....	1-19

## 3. System Operators

<b>Defining System Operators.....</b>	<b>1-21</b>
Adding New Operators .....	1-21
Access Definitions .....	1-22
Changing Operator Names .....	1-23
Changing Operator Passwords .....	1-23
Updating Operator Information .....	1-24
Deleting Operators.....	1-24

## 4. Customer Information

<b>Adding Customer Accounts.....</b>	<b>1-25</b>
<b>Changing Customer Account Information .....</b>	<b>1-27</b>
<b>Deleting Customer Accounts .....</b>	<b>1-27</b>
<b>Restoring/Purging Customer Accounts.....</b>	<b>1-28</b>
Purging a Customer Account.....	1-28

---

Restoring a Customer Account .....	1-29
<b>Searching/Sorting Customer Data .....</b>	<b>1-29</b>
The Sort By Option .....	1-29
Searching for Customer Accounts .....	1-30
<b>Purging History Data .....</b>	<b>1-30</b>
<b>Purging Event Logs .....</b>	<b>1-31</b>
<b>Renaming Receiver Group .....</b>	<b>1-32</b>
<b>Exporting and Importing Accounts .....</b>	<b>1-33</b>
Exporting an Account .....	1-33
Importing an Account .....	1-34
<b>Customizing the Customer Account Screen .....</b>	<b>1-34</b>
Making Changes to the Layout .....	1-34
Saving the Changes .....	1-35
<b>Viewing Unattended Jobs .....</b>	<b>1-35</b>
<b>Defaulting Panel Information .....</b>	<b>1-36</b>
<b>Modifying Panel Information .....</b>	<b>1-37</b>
<b>Scheduling Jobs .....</b>	<b>1-37</b>
<b>Viewing Event Logs .....</b>	<b>1-38</b>

## 5. Control Panel Information

<b>Alarm Control Programming .....</b>	<b>1-39</b>
<b>Panel Application for Compass 16 .....</b>	<b>1-40</b>
Overview .....	1-40
Menu Bar options .....	1-40
Programming an Alarm Control .....	1-43
<b>Panel Application for Compass 2.0 .....</b>	<b>1-43</b>
Overview of the panel .....	1-44
The Menu bar .....	1-46
Save Changes Dialog .....	1-48
Configuration Groups .....	1-49
Partitions .....	1-49
Adding and Removing partitions .....	1-50
Configuring Common Data .....	1-51
Configuring Partition Specific Data .....	1-52
Dialer .....	1-54
Device .....	1-57
Globals .....	1-57
Users .....	1-61
Zones .....	1-62
Zone Configuration .....	1-62
Cross-Zoning Pairs .....	1-63
Schedule .....	1-64
Relay .....	1-68
Access .....	1-71
Change and Compare .....	1-73
Change .....	1-73
Compare .....	1-74
History .....	1-75

---

<b>Using Templates .....</b>	<b>1-76</b>
Creating New Templates .....	1-77
Modifying Templates .....	1-78
Deleting Templates .....	1-78
Setting Up an Existing Customer Template .....	1-78
Using a Template to Create a New Account .....	1-79
<b>Copying an Account .....</b>	<b>1-79</b>
<b>6. Interactive Communications</b>	
<b>On-Line Communications .....</b>	<b>1-81</b>
<b>Ademco .....</b>	<b>1-81</b>
Launching the Ademco Commserver .....	1-81
Available Options in Ademco.....	1-89
Log reports available in Ademco.....	1-90
Configuring for Answering Machine Defeat .....	1-90
<b>FBII.....</b>	<b>1-91</b>
Launching the FBII Commserver .....	1-91
Setting up the Modem for FBII panels .....	1-93
Available Options in FBII.....	1-94
<b>Apex .....</b>	<b>1-95</b>
Launching the Apex Commserver .....	1-95
<b>Event Logs.....</b>	<b>1-98</b>
<b>7. Unattended Communications</b>	
<b>Unattended Operation .....</b>	<b>1-100</b>
Unsolicited Mode.....	1-100
Scheduled Mode .....	1-100
Mixed Mode .....	1-100
<b>Assigning Receiver Groups.....</b>	<b>1-100</b>
<b>Viewing Scheduled Jobs.....</b>	<b>1-102</b>
Viewing the Commands and Activity Log Information .....	1-104
Opening the Scheduler.....	1-105
Viewing Customer Account Details .....	1-105
Deleting Unattended Jobs .....	1-106
<b>Using Unattended Mode .....</b>	<b>1-107</b>
Working of the Scheduled Mode .....	1-107
Starting the Unattended Server .....	1-107
<b>Ademco Unattended Communications.....</b>	<b>1-109</b>
Setting up Ademco Unattended Mode .....	1-109
Scheduling Ademco Unattended Jobs .....	1-111
How the Ademco Unsolicited Mode works.....	1-115
Setting Up an Ademco Panel to Call an Unsolicited Server.....	1-117
<b>FBII Unattended Communications.....</b>	<b>1-118</b>
Setting up FBII Unattended Mode.....	1-118
Scheduling FBII Unattended Jobs .....	1-118
How the FBII Unsolicited Mode works.....	1-120
Setting up the FBII Panel to Call Unsolicited Server .....	1-120

---

<b>Apex Unattended Communications .....</b>	<b>1-121</b>
Starting Apex Unattended Mode .....	1-121
Scheduling Apex Unattended Jobs .....	1-122

## **8. On-Line Commands**

<b>Selecting a Command.....</b>	<b>1-124</b>
Other Tools .....	1-124
<b>List of Commands .....</b>	<b>1-125</b>
<b>Descriptions.....</b>	<b>1-129</b>
Changing CSID and Phone Number – Ademco .....	1-129
Changing CSID .....	1-129
Changing the Phone Number .....	1-130
Displaying Messages .....	1-131
Arming/Disarming .....	1-132
Setting the Time .....	1-132
Viewing Event Log (Ademco).....	1-134
Shutting Down a Panel (Ademco) .....	1-135
Bypassing a Zone .....	1-136
Sending a Test Report (Ademco).....	1-137

## **9. Database Management Utility**

<b>Overview.....</b>	<b>1-138</b>
<b>Change Database .....</b>	<b>1-138</b>
<b>Backup Database .....</b>	<b>1-140</b>
<b>Restore/Purge Databases .....</b>	<b>1-142</b>
Restore Database.....	1-142
Purge Database .....	1-144
<b>Migrate Database .....</b>	<b>1-145</b>
<b>Delete Database.....</b>	<b>1-146</b>
<b>Client Installation .....</b>	<b>1-148</b>

## **10. Bug Reporter**

Access through Startup Menu.....	1-149
Access through Compas Application.....	1-149
Access through Utility Folder.....	1-150

## **11. New Features in Compass 2.0 151**

<b>Overview.....</b>	<b>1-151</b>
<b>Descriptions.....</b>	<b>1-151</b>
Selecting Commands using Drag-and-Drop .....	1-151
Common User Interface.....	1-152
Single Window for Configuring Multiple Commands .....	1-152
Connecting through TCP/IP and Dialup Simultaneously .....	1-153
Activity Log .....	1-153
Unattended/Unsolicited Mode Features.....	1-155
Working with Multiple Panels .....	1-155
Interactive Mode Features .....	1-155
Export and Import Subscriber .....	1-155



---

Exporting Subscriber Information .....	1-156
Importing Subscriber Information .....	1-158
Import Subscribers – Options .....	1-162
Importing Information from Other Sources.....	1-163
Panels Report .....	1-164
Viewing All Customer Records .....	1-164
Printing Customer Detail .....	1-164
Purge Event Logs.....	1-165
Other Important Features .....	1-165
APPENDIX A 167	
Error Conditions .....	2-167

## Guide Structure

This guide describes the tasks that you can perform using the Compass Downloader tool. The chapters in the guide are arranged in an order that helps you get familiarized with the application quickly.

The guide is divided into ten chapters:

- Chapters 1 and 2 include the basic information about the Compass Downloader, such as key features, the Downloader menu structure, and Downloader installation.
- Chapters 3 and 4 take you through the Downloader setup and cover those tasks that need to be performed only once, such as the modem setup.
- Chapters 5 through 8 cover the activities performed using the Downloader. These chapters include adding and modifying customer accounts, communicating with the panel and Central Station, and a listing of on-line commands and their descriptions.
- Chapter 9 describes database management utility.
- Chapter 10 gives an overview and description of the new features in Compass 2.0.
- Appendix A describes error conditions, including troubleshooting.



# 1. Introduction

## 1.1 Compass 2.0 Overview

Compass 2.0 provides you with the tools you need to program and control an alarm system remotely from the comfort of your office. You can download and upload alarm control information, compare the uploaded and saved information, and view the results on screen or as a printed report.

Using Compass 2.0, you can program an alarm system at the office prior to installation, or can download the programmed information from a remote location, or at the job site using a laptop. You can download from a remote location through telephone lines, through IP, or through GSM.

Compass 2.0 System supports both Compass 16 and Compass 2.0 accounts.



### Downloader Program Structure

Compass 2.0 consists of three main programs, namely the **Shell**, the **Panel Application**, and the **Communication Server**.

When you start the software, the logo is displayed first, and then the Log In screen is displayed. After you enter a valid Operator name and password, the Compass “Shell” screen is displayed.



#### **REFERENCE- INTERNAL**

For more details on Log on and Log off, refer to [2.3 Logging On](#) and [2.4 Logging Off](#).

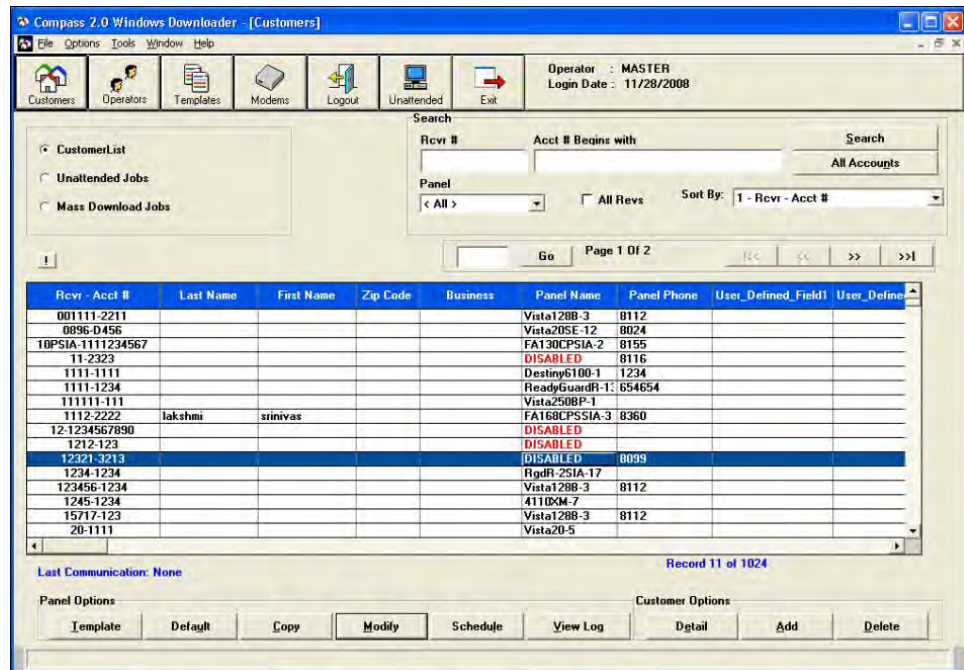

**Figure 1-1 Compass 2.0 Shell**

From the Shell, you can access program-wide options, such as Logout and Exit, Station Data, and Operator Setup. You can also configure Customer Accounts.

From the Customer Accounts list, you can access the customer account's Alarm Control Panel configuration.

From the Panel Edit screen, you can go to the Communications Program, connect to a customer's alarm control panel, and execute commands on-line. You can perform activities such as arming or disarming the panel; programming the panel configuration (downloading); or uploading configuration and settings that were programmed to the panel.

## 1.2 System / Software Requirements

System Attribute	Minimum	Recommended
Processor	256 MB RAM	512 MB RAM
Disk Space (Free)	1 GB	>1 GB
Monitor Resolution	800 X 600	1024 X 768

Application	Version
Operating System	<ul style="list-style-type: none"> <li>• Windows 2000-SP4</li> <li>• Windows XP SP3 - Home Premium, Professional and Ultimate</li> <li>• Windows 2003 SP2 - Small business server and Standard edition</li> <li>• Windows Vista SP2 - Home Basic, Home Premium, Business &amp; Ultimate</li> <li>• Windows 7- Home Premium, Professional &amp; Ultimate</li> </ul>
Database	<p data-bbox="922 642 1365 800">Note: Not all panels are supported in windows Vista and Windows 7 OS. To view the list of panels supported by MS Vista or Windows 7 OS, Please refer to release notes.</p> <p data-bbox="922 821 1365 884">MS SQL Server 2000 ,MS SQL Server 2005, MS SQL Express 2005</p> <p data-bbox="922 894 984 926">Note:</p> <ul style="list-style-type: none"> <li>• MSSQL Express is installed in the following scenarios:</li> <li>• If MSSQL Express is not installed, the setup installs MS SQL Express with Compass 2.0 as the instance name.</li> <li>• If MSSQL Express is installed with a different instance name, the setup gives you the option to install the Compass 2.0 instance name or use the existing instance.</li> <li>• If SQL Express is already installed with compass 2.0 as the instance name, the setup uses the existing instance.</li> <li>• Windows 95, Windows 98 and Windows NT Operating systems are no longer supported by Compass2.0</li> <li>• MS SQL MSDE and MS Access database are no longer supported by Compass 2.0.</li> <li>• Do not delete the Compass folder from the computer to remove Compass 2.0. This may corrupt the registry.</li> </ul>
Microsoft Internet Explorer	<ul style="list-style-type: none"> <li>• 5.5 or above</li> </ul>

Compass 2.0 does not support simultaneous windows user sessions:

Scenario#1: Compass may not work, If a user tries to login when another active session is open on the same computer.

Scenario#2: Multiple user sessions across the network is not possible on a server based operating system such as Windows 2000 or Windows 2008 server environments



**ATTENTION**

Windows 95, Windows 98, Windows NT, SQL MSDE database, and access database are no longer supported by Compass 2.0.

### 1.3 Viewing Product and System Information

The Help menu of Compass 2.0 Shell provides an “About” box, which provides the product version number, installation information, and operator information.

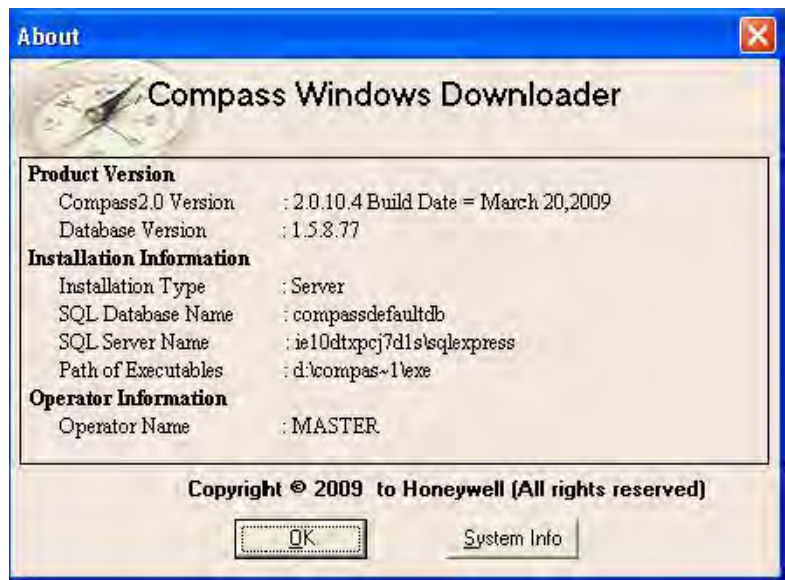

Figure 1-2 Product, Installation, and Operator Information

Information	Description
<b>Product Version</b>	Details regarding the product
Compass 2.0 Version	Current version of Compass Build
Database Version	Current version of Database
<b>Installation Information</b>	Details regarding installation paths
Installation Type	Gives the type of Compass 2.0 installation as Server or Client
SQL Database Name	Database name in the SQL Server to which Compass is connected to.

SQL Server Name	SQL Server Name to which Compass is connected to.
Path of Executables	Gives the location of the executables on the system
<b>Operator Information</b>	Details regarding the operator
Operator Name	Gives the login name of the operator

Click **System Info** in the About box to view the system information details.

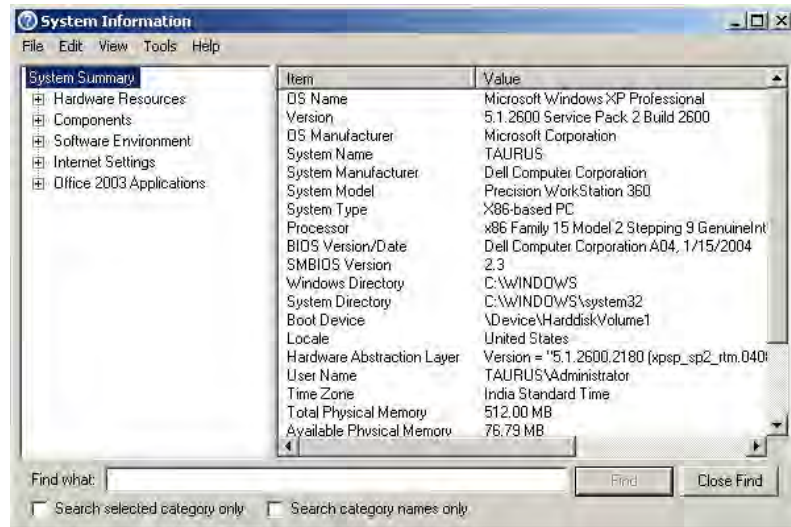

Figure 1-3 System Information

## 1.4 Viewing a List of Panels Supported by Compass 2.0

To view the list of panels supported by Compass 2.0, perform the following steps:



Step	Action
------	--------

- 1 Click the **Unattended** icon in the Compass Windows Toolbar.  
The Launch Unattended Server dialog box is displayed.



- 2 Click **Help**.  
Compass 2.0 **Windows Downloader** window is displayed.

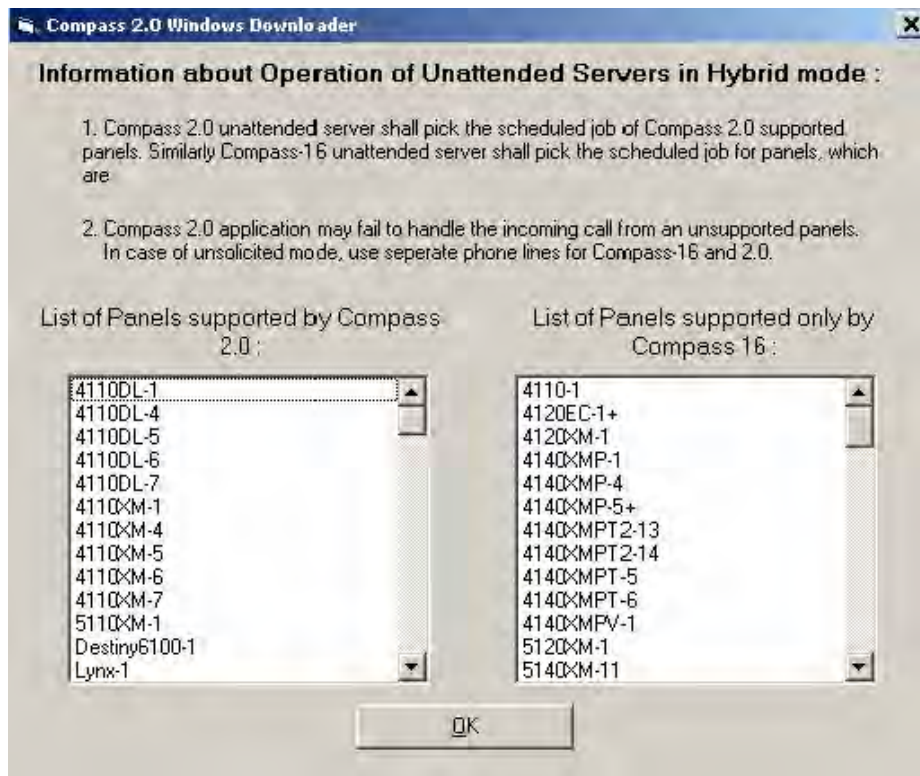

- 3 Scroll down the list to view the panels supported by Compass 2.0 and the panels supported by Compass 16.

## 1.5 Getting Product Updates

You can acquire any future updates through Honeywell directly, or download them from our Internet site:

**<http://www.security.honeywell.com/hsce/>**

### Latest Build and Patch Information

**Ademco:** Build 1.5.8.0 and last released update Patch – e.g 1.5.8.54 or later.

## 2. Communications Setup

### 2.1 Setting up Downloader Communications

To set up communication with different protocols, you must set up a modem for each protocol in the Communication Setup screen.

The list of modems supported in Compass 2.0 for each protocol can be viewed in the Standard Modems pane of the **Communication Settings** dialog box.

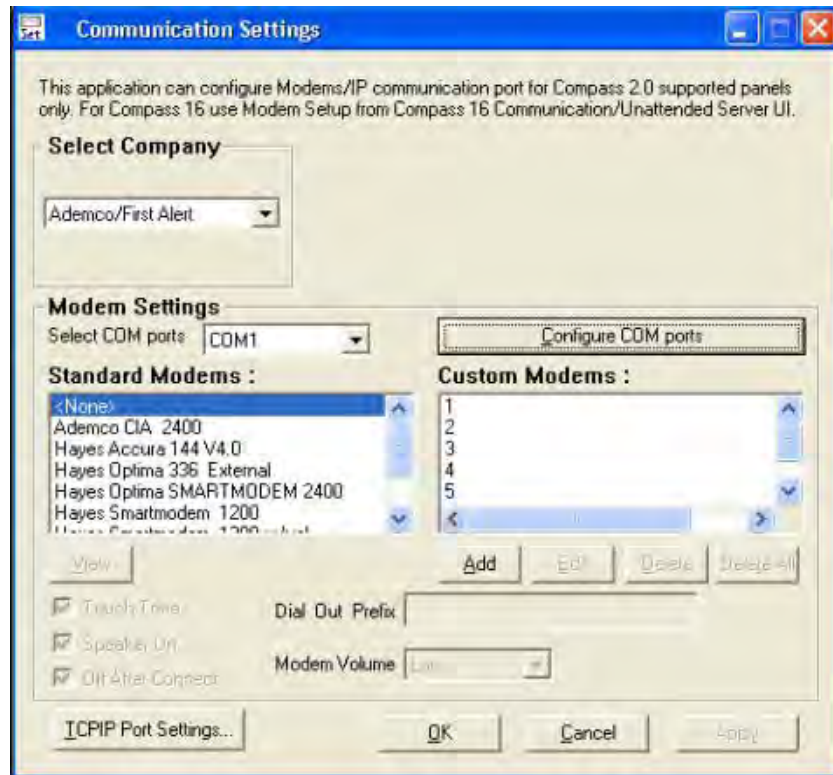



Figure 3-1 Communication Settings



### 2.2 Setting up the Modem



To set up the modem, click  on the Compass Shell toolbar or click **File> Communication Setup** in the **Compass Communications** screen.

The **Communication Settings** (Figure 3-1) dialog box is displayed.

The modem is set up as follows:

Parameter	Description
Select Company	<p>From the list of companies, select the name of the company whose panel you are using. If FBII is selected, the Interface needs to be configured accordingly.</p> <p> <b>REFERENCE- INTERNAL:</b> For more information on configuring FBII refer to <a href="#">FBII F7702 Interface</a>.</p>
Modem Settings	
Select COM Ports	<p>Select the option, ‘ List all COM Ports including virtual ports’, to view all the virtual comports along with the physical comports available in the system.</p> <p>The available COM ports will be displayed in the drop down “Select COM Port for Compass”</p>
	
	<p>Click <b>Add</b> or <b>Delete</b> in the displayed window to add or delete COM ports. The selected port is used for Compass communications.</p>
Standard Modems	<p>Based on the protocol selected, the corresponding standard modems are displayed. To view details of the modem, select the modem and click <b>View</b>.</p> <p>The <b>View Modem Properties</b> Dialog box is displayed.</p>

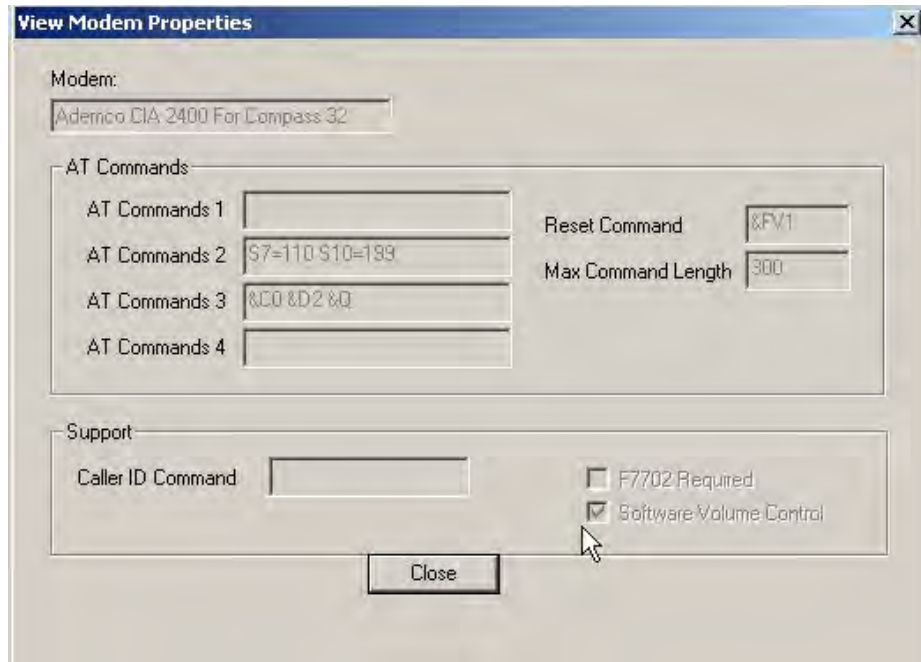

- Custom Modem                      To add a new modem that is not in the list, click **Add**. The Add/Edit Modem screen is displayed. Configure it as detailed in the section [Adding Modems](#).
- Dial Out Prefix                    It is a unique number used for identifying the panel from which the call comes.
- Touch Tone                         Select this, if you prefer touch tone dialing. The default type is Rotary, or pulse dialing.
- Speaker On                         Select this, if you want the speaker on.
- Off After Connect                 Select this, to turn off speaker after connecting.
- Modem Volume                     Set modem volume. Select High, Medium, or Low, from the drop-down list.
- TCP/IP Port Settings             Click to configure TCP/IP port. The configure TCP/IP port dialog is displayed.

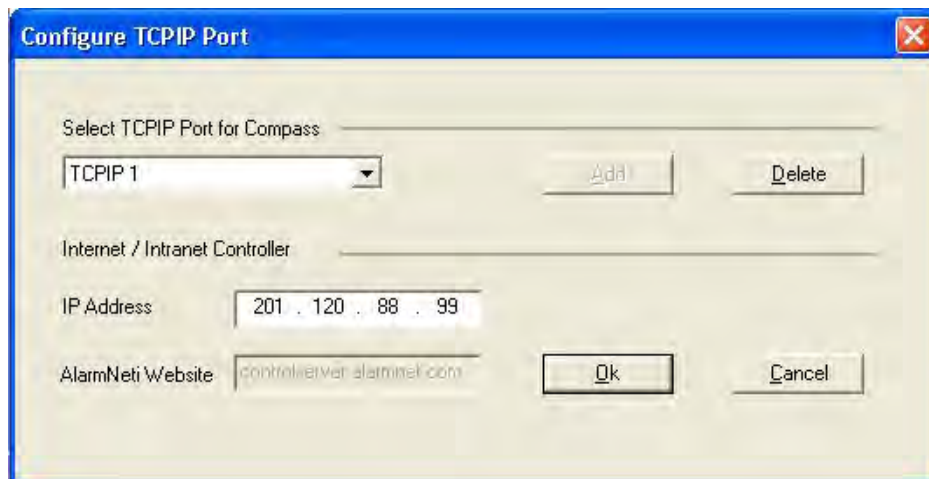

TCP IP Port

Select the TCP IP Ports. To add more ports, click **Add**. To remove ports, click **Delete**.

Internet/Intranet Controller

Type the **IP Address** of the Control Server of the customer location.

While communicating over the Internet through Alarmnet, enter the **AlarmNet-i Website** address/URL where the Control Server is running, as shown in the display (this is set to a default value of "controlserver.alarmnet.com".)

Click **OK**.

Click **Apply**, to apply the above settings to the modem.

## FBII F7702 Interface

F7702 is a modem interface for use with Compass 2.0. This allows a wider range of modems to be used and provides a local mode of operation.



You can connect with the panel remotely or locally depending on the modem configurations in the Shell.

The modem configuration screen allows you to type the value for a Remote Code Suffix and a Local Code Suffix. In most cases, the default values of \*\*1 for the remote and \*\*0 for the local is used. These options exist to accommodate situations where the phone company or your PBX uses \*\*0 or \*\*1.

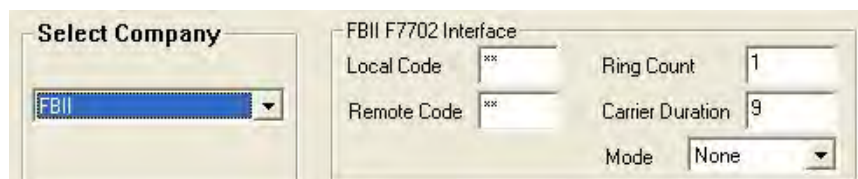
If the company selected in **Communication Settings** is FBII, the FBII F7702 Interface must be configured as:



**Figure 3-2 FBII F7702 Interface**

Parameter	Description
Local Code	<p>This refers to the code passed to the model F7702 Interface to place it in local mode. The default of '***' should work fine; however, it may be changed to any two digits (including * or #) to suit your line needs. This mode is programmable on the F7702 Interface.</p> <p> <b>REFERENCE– EXTERNAL:</b> Refer to F7702 Interface User Guide for programming instructions.</p>
Remote Code	<p>This refers to the code passed to the F7702 Interface to place it in remote mode. The default of '***' should work fine; however, it may be changed to any two digits (including * or #) to suit your line needs. This mode is programmable on the F7702 Interface.</p> <p> <b>REFERENCE– EXTERNAL:</b> Refer to F7702 Interface User Guide for programming instructions.</p>
Ring Count	<p>It is the number of rings after which the panel would answer.</p>
Carrier Duration	<p>It is the carrier duration for the F7702 Interface.</p>
Mode	<p>Set this to <b>Remote</b> or <b>Local</b> based on whether the communications performed with the F7702 Interface are remote or local. Select <b>None</b> when the F7702 Interface is not being used.</p>

## Adding Modems

Modems can be **Standard**, shipped with the downloader; or **Custom**, which you can configure yourself.

In case of Standard modems, you can only view properties by clicking **View**, but cannot modify them.

To add a new custom modem, perform the following steps:

Step	Action
1	Click <b>Add</b> under <b>Custom Modems</b> in the <b>Communication Settings</b> dialog box. The <b>Add/Edit Modem</b> dialog box is displayed.

- |   |   |
|---|---|
| 2 | Type the name of the modem under <b>Modem</b> .   |
| 3 | Type the modem commands, or select the modem <b>template</b> to be used from the <b>Template</b> drop-down.<br>If a template is selected, the AT commands, Reset Command, and Max Command Length are automatically filled as defined in the template. |
| 4 | If your modem supports the Caller ID feature, type the <b>Caller ID Command</b> on the Support frame.   |
| 5 | Click <b>OK</b> .   |

## Editing Modems

The Edit and Delete options are applicable only to the Custom Modems. Modem settings that were shipped with the Downloader cannot be edited or deleted.

To edit a modem's settings, perform the following steps:

Step	Action
1	Select the modem from the <b>Custom Modems</b> list in the <b>Communication Settings</b> window.



- 2 Click **Edit**.



**ATTENTION:** The **Edit** and **Delete** buttons are disabled if there are no Custom Modems.

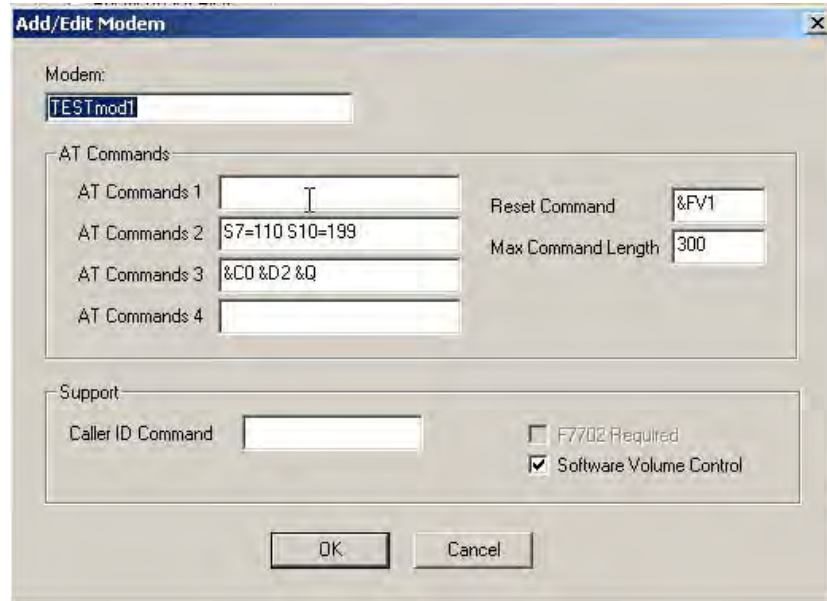

- 3 Edit the modem commands or/and the Caller ID Command.
- 4 Click **OK** to save the new commands, or click **Cancel** to quit without saving.

## Deleting Modems

To delete a modem, select the modem from the list box and click **Delete**. Click **OK** to confirm the deletion.

You can also delete all the Custom modems using the **Delete All** button.

## 2.3 Configuring Modem Switch Settings

This section helps you configure modems that have manual switch settings.

### Hayes Smartmodem 1200 External Modem

Configure the DIP switches behind the modem's front panel:

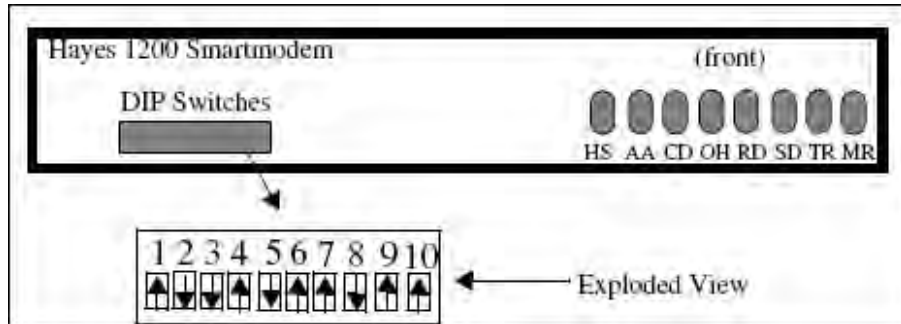

Figure 3-3 Hayes Smartmodem 1200 External Modem

### Hayes Smartmodem 1200(B) Internal Modem

The rear view of the Smartmodem 1200(B) Internal Modem is illustrated below:

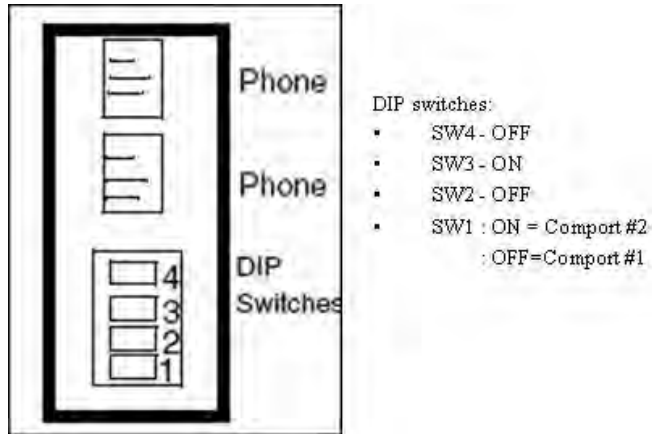

Figure 3-4 Hayes Smartmodem 1200(B) Internal Modem

## 2.4 Mapping Devices to IP

You can add, edit, or delete a mapping of Device to IP address using the Device or Computer Name / IP Address function.

Enter information about all the 7810iR modules that Compass will be connecting to by typing the **IP address of 7810iR** and a **Device name** to identify it, as described below.

Step	Action
1	On the Customer screen menu of the Downloader, select <b>File &gt; Device or Computer Name / IP Address</b> .



The **Device or Computer Name / IP Address** screen is displayed.

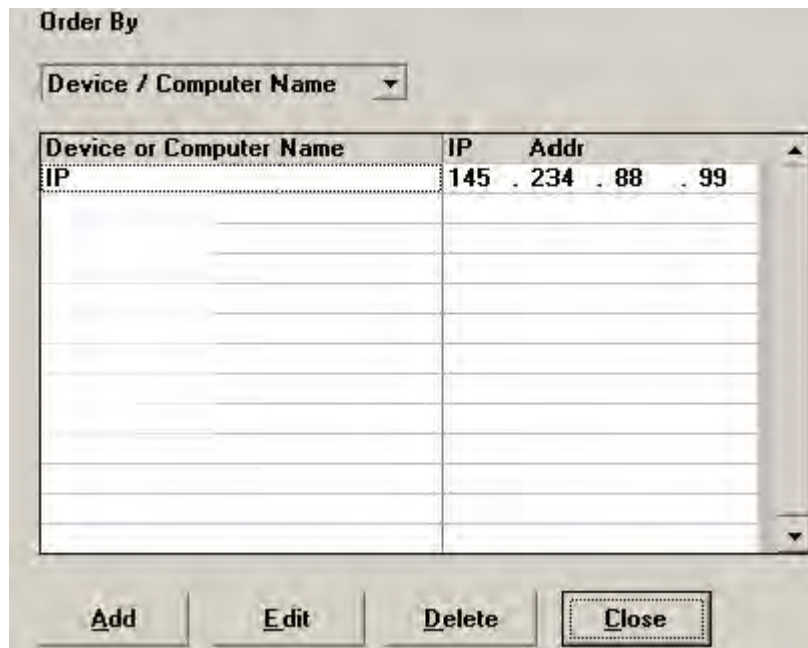

- 2 Click **Add** in the bottom toolbar of the screen.
- 3 Type the Device or Computer name details and the corresponding IP address.

- 4 Click **Ok**. (When the screen is in Add Mode, the Add button changes to Ok).

## 2.5 Configuring Station Data

The **Station Data** window is used for adding or editing Customer Class description, Station CSID, and user defined fields. You can access this window from the **File** menu of the customer screen.

### Central Station ID

The Central Station Identification number (CSID) serves as the identity of the company that installed the control panel. This prevents unauthorized remote access to the panel. This number is transmitted by the computer and is verified by the control panel during an attempt to get on-line for downloading.

The CSID must be of eight characters (consisting of 0-9, A-F) for Ademco panels. Your administrator assigns this number. Only the first six characters are used for FBII. Destiny and Focus panels do not use this ID.

When authorized, you can view or change the CSID on the Dialer screen when modifying an alarm control panel.

### Configuring CSID

To configure CSID, perform the following steps:

Step	Action
1	Click <b>File</b> in the menu bar of the Compass Shell.
2	Select <b>Station Data</b> from the menu. The Station Data screen is displayed.

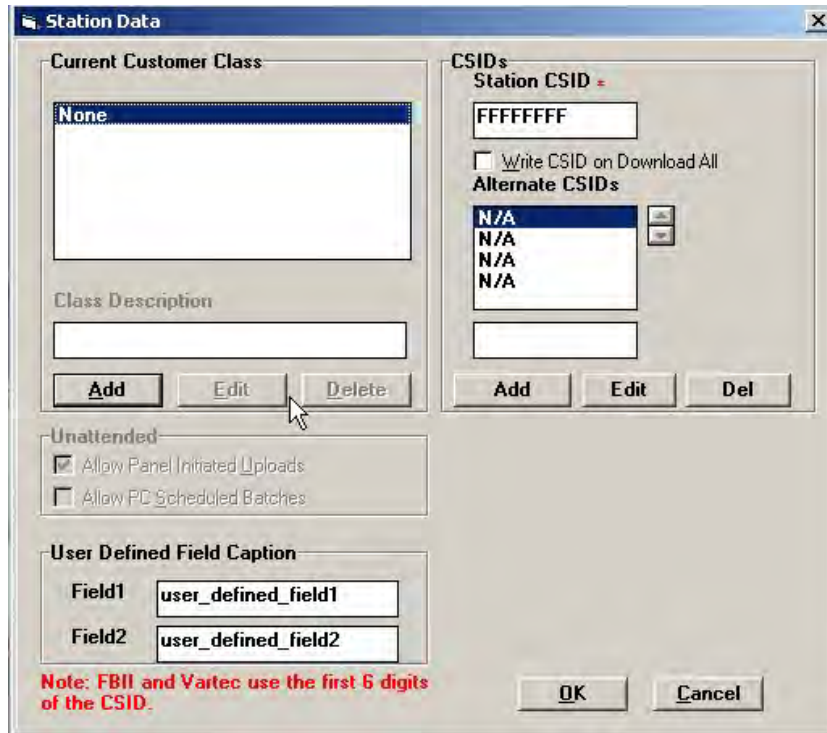

- 3 Click **Add**. The Class Description field becomes editable.
- 4 Type a description (Example: Home User)  
The description reflects in the Current Customer Class pane.

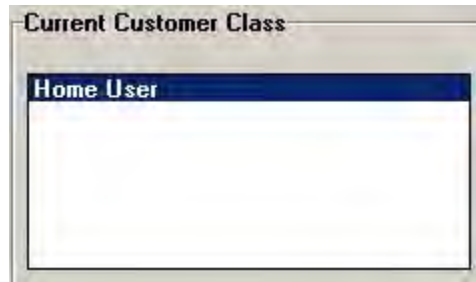

- 5 In the **Station CSID** field, type your CSID number.
- 6 Select **OK** to save and quit, or **Cancel** to quit without saving.



**TIP:** After an account is saved, the CSID is stored in that account, so that a change to the Station CSID does not change the account CSID.

- 7 If you want to download the current station CSID to all Compass-downloaded panels, select **Write CSID on Download All**.

- 8 Some panels allow multiple attempts by the Downloader to match the CSID. To enter alternate CSIDs, perform the following steps:
- Click the **Add** button under the **Alternate CSIDs** text box.
  - The text box is enabled. Type the CSID in the text box.
  - Click **OK**. The new CSID is added to the list of alternate CSIDs.
  - You can make changes to the list by using the **Edit** option. To delete any of the CSIDs, select it, and click **Delete**.

## Changing the CSID

To change the CSID of an account, connect to the panel from the Communications screen, click **Modify** and change the CSID on the Dialer screen of the panel. Then download the panel.

In Unattended mode, you can download the current station CSID to all Compass-downloaded panels by selecting **Write CSID on Download All**. This changes the CSID to the new CSID specified in **Station Data**. Clicking the **View CSID** button in the Dialer of the panel, displays the new station CSID.

This will be applicable for Unsolicited calls but in case of Unattended batches we need schedule a job with Change CSID command.



### REFERENCE- INTERNAL

For more information on Commands refer to On-Line Commands 8. On-Line Commands.

## Customizing User-Defined Fields

There are two user-defined fields on the Station Data screen. You can customize these fields, and then use them on the Customer Information screen as sort criteria to help organize customer accounts.

As an example, in Figure 3-5, **user\_defined\_field 1** is replaced by **Area Code**. This change is reflected on the customer screen.

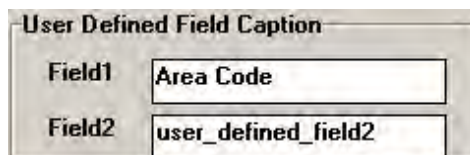

Figure 3-5 User Defined Fields

This field is now displayed in the **Sort by** list as-well-as in the customer details table heading.

The screenshot shows the 'Compass 2.0 Windows Downloader - [Customers]' application window. The interface includes a menu bar (File, Options, Tools, Window, Help), a toolbar with icons for Customers, Operators, Templates, Modems, Logout, Unattended, and Exit, and a status bar showing 'Operator : MASTER' and 'Login Date : 12/1/2008'. A search section contains fields for 'Rcvr #', 'Area Code Begins with', and 'Panel', along with a 'Search' button and an 'All Accounts' checkbox. A 'Sort By' dropdown menu is open, showing a list of sorting options: 7 - Area Code, 2 - Last Name, 3 - First Name, 4 - Zip Code, 5 - Business, 6 - Panel Name, 7 - Area Code, 8 - user\_field\_2, and 9 - Create Date. The 'Area Code' option is highlighted in red. Below the search section is a table with columns: Rcvr - Acct #, Area Code, Last Name, First Name, Zip Code, Business, and Panel Name. The 'Area Code' column header is highlighted in red. The table contains three rows of data:

Rcvr - Acct #	Area Code	Last Name	First Name	Zip Code	Business	Panel Name
1234-1323						Vista128B-3
uyii-1221						Vista128BP-3
raghu-1223						Vista128BP-3



**ATTENTION**

You can configure or change Station Data only if you have Administrator privileges.

## 3. System Operators

### 3.1 Defining System Operators

After setting your communications options, the next step is to define Downloader system operators.

You can assign different levels of authority to operators, allowing/restricting access to various system and control panel operations.

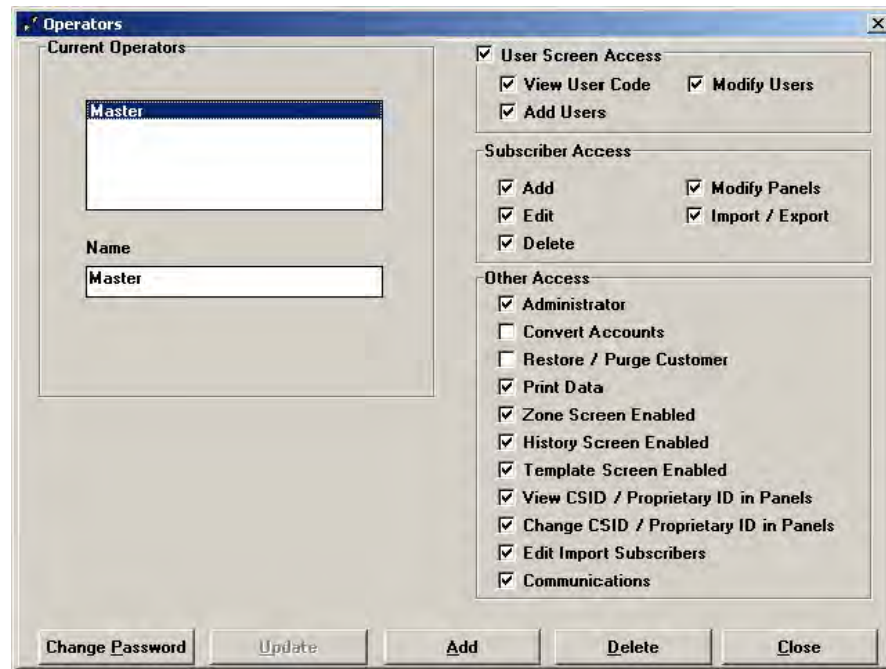



Figure 4-1 Operators - Access

### Adding New Operators

To add a new operator, perform the following steps:

Step	Action
1	 <p>Click  on the Compass Shell screen toolbar to display the <b>Operators</b> window.</p>
2	Click <b>Add</b> in the bottom panel of this window.
3	<p>The left pane of the screen changes (compare the figure below with Figure 4-1) allowing you to type an operator's name and password.</p> <p>The new password must be typed twice—once under <b>New Password</b>, and again under <b>Retype Password</b>.</p>



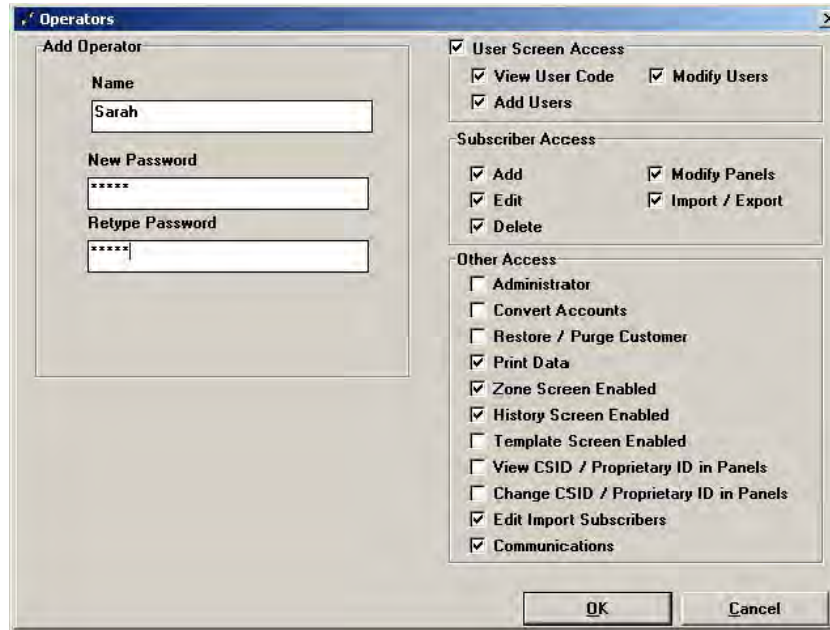

- 4 Select the Access properties for this operator from **User Screen Access**, **Subscriber Access**, and **Other Access**.
- 5 Click **OK** to save the addition.

## Access Definitions

Option	Allows you to...
<b>User Screen Access</b>	View control panel user screen when modifying control panel programming.
View User Code	View control panel user codes.
Add Users	Add control panel user codes.
Modify Users	Edit or delete control panel user codes.
<b>Subscriber Access</b>	Handle subscriber data.
Add	Add new customers to database.
Edit	Edit existing customer information.
Delete	Delete customers from database.
Modify Panels	Access and change alarm control information.
Import / Export	Import/export Compass accounts.
<b>Other Access</b>	

Administrator	Configure or modify any Compass 2.0 screen. Without this authority, you cannot view the Operator or Station Data screens.
Convert Accounts	Convert DOS accounts utility is not available in Compass 2.0. It is available in the Compass 16 bit Shell. This access option is available in Compass 16 bit since it enables/disables the option File->Receiver Group/CS Phone number # in Shell.
Restore / Purge Customer	Restore or completely purge customer accounts.
Print Data	Print all alarm control information.
Zone Screen Enabled	Access the Zone Information screen for the control.
History Screen Enabled	Access the History Screen for the control.
Template Screen Enabled	Access the Create Templates screen.
View CSID / Proprietary ID in Panels	View the Central Station Identification Number.
Change CSID / Proprietary ID in Panels	Change the Central Station Identification Number.
Edit Import Subscribers	Change import subscriber options and settings.
Communications	Communicate with panels.

## Changing Operator Names

If you want to change an operator's name, perform the following steps:

Step	Action
1	Highlight the name to be changed in the <b>Current Operators</b> list of the Operator window (refer to <a href="#">Figure 4-1 Operators - Access</a> ).
2	Type the new name in the text box below.
3	Click <b>Update</b> at the bottom of the Operators screen.



**ATTENTION:** The **Update** button is enabled when you type a new operator name.

## Changing Operator Passwords

If an operator forgets or wants to change his password, an Administrator can assign a new password.

To assign a new password, perform the following steps:

Step	Action
------	--------

- 1 Click **Operators** on the Compass Shell screen toolbar to display the Operators screen.
- 2 Select the operator from the Current Operators list in the **Operators** window.
- 3 Click **Change Password**.  
The Change Password screen is displayed.



- 4 Type the new password and confirm by retyping it.
- 5 Click **OK** at the bottom of the screen.



**ATTENTION**

Only an Operator with Administrator privilege can change the password.

## Updating Operator Information

You can update or change an Operator's access status.

To change an Operator's access levels, perform the following steps:

Step	Action
1	Click <b>Operators</b> on the Compass Shell screen toolbar to display the Operators window.
2	Select the operator from the Current Operators list in the <b>Operators</b> window.
3	Modify the access levels for the operator.
4	Click <b>Update</b> .

## Deleting Operators

To delete an operator name, select an operator's name from the **Current Operators** list and click **Delete** (refer to [Figure 4-1 Operators - Access](#) ). Click **OK** when asked for confirmation.

## 4. Customer Information

All relevant details of customers and their accounts are recorded and viewed on the Customer screen. This data is used for setting your customer database.

### 4.1 Adding Customer Accounts

To create a new customer account, perform the following steps:

Step	Action
1	<p>Click  in Compass 2.0 Shell toolbar. The <b>Customers</b> screen is displayed.</p> 
2	<p>Click <b>Add</b> from the Customer Options box at the bottom-right of the screen. The <b>Customer Detail</b> screen is displayed.</p>

Figure 5-1 Customers

- 3 Type the Receiver Group number (up to 6 characters).
- 4 Type the 3-, 4-, or 10-digit Subscriber Account Number.
- 5 Type your name, address, and contact numbers in the text boxes provided.
- 6 Select the Panel Type and Revision.

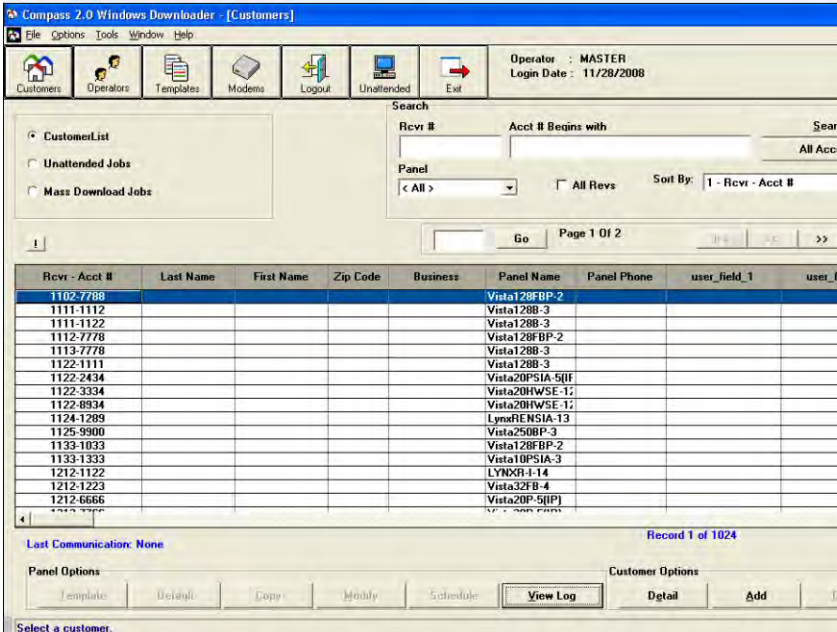

**TIP:** The revision determines which programming fields the Downloader displays. If you are uncertain of the revision, select the highest available.

- 7 Select the Panel Class.
- 8 Type the Panel Phone Number
- 9 For panels that support TCP/IP connections, type the 12-digit **MAC address** of the network device.



**TIP:** This address must match the MAC address of the 7845i module that is connected to the panel at the customer location.

- 10 If you want to print the customer account information, click **Print**.
- 11 Click **OK**.



**TIP**  
If there is any other information that you would like to capture, use the text box under **Notes**, for the purpose. You can type up to 255 characters.

## 4.2 Changing Customer Account Information

To change the customer account information, perform the following steps:

Step	Action
1	Go to the Customer screen of Compass 2.0 Shell.
2	Click the customer account you would like to change.
3	Click <b>Detail</b> in the Customer Options box at the bottom-right of the screen. The <b>Customer Detail</b> dialog box is displayed.
4	Make the necessary changes. To print the customer account information changes, click <b>Print</b> .
5	Click <b>OK</b> to save the changes, or <b>Cancel</b> to quit without saving the changes.

## 4.3 Deleting Customer Accounts

To delete Customer Accounts, perform the following steps:

Step	Action
1	In the Customers screen, click the customer's name from the list.
2	Click <b>Delete</b> in the Customer Options box at the bottom-right of the screen. The following screen is displayed:



- |   |  |
|---|--|
| 3 | Select <b>Delete Selected</b> (deletes highlighted account only) or <b>Delete All</b> (deletes all accounts displayed in the customer grid). |
| 4 | Click <b>Ok</b> .  |



### ATTENTION

When you delete a customer as described above, the information is not completely removed. You must then “purge” the account to completely delete it. Refer to section [4.4 Restoring/Purging Customer Accounts](#) for details.

## 4.4 Restoring/Purging Customer Accounts

### Purging a Customer Account

You must purge an account before reusing that account and receiver number.

Step	Action
1	Go to the Compass Customer Information screen.
2	Click <b>Tools&gt; Restore/ Purge Customer</b> . The <b>Restore/Purge Accounts</b> dialog box is displayed.

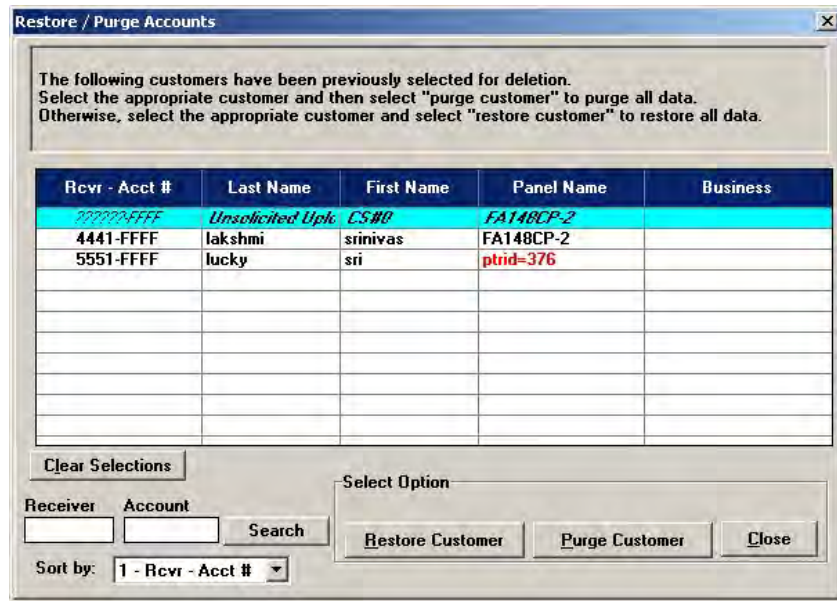

- Select the account by clicking the required rows in the Rcvr-Acct # column. The selected account is highlighted.
- Click **Purge Customer**. The **Purge Records** dialog box is displayed.



- You can choose to purge the highlighted accounts, or all the accounts displayed on the screen. Click **Ok** to purge.

## Restoring a Customer Account

To restore a deleted account, select the account and click **Restore Customer** in the **Restore/Purge Accounts** dialog box. Click **Ok** to confirm the selection.

The account is restored.



### ATTENTION

A deleted account can be restored. A purged account cannot be restored.

## 4.5 Searching/Sorting Customer Data

There are various ways to display customer information based on requirement.

### The Sort By Option

You can use the **Sort By** option to base your sort on:

- Receiver Account Number
- Last Name
- First Name
- Zip Code
- Business
- Panel Phone
- user\_defined\_field 1 (Defined as Area Code in the figure)
- user\_defined\_field 2
- Create Date
- Modified Date
- Last Communication Date
- Mass Download Job Name
- MAC Address

Go to the Customer screen in the Compass Shell. To the top-left, above the Customer table, you will find the **Sort By** drop-down.

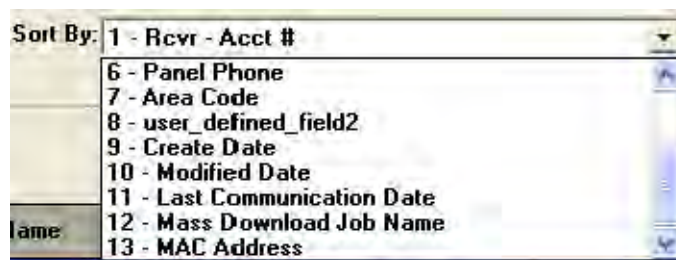

Figure 5-2 The Sort By Option

To select the sort method, click the selection from the drop-down box. As a reminder, the field that you selected to sort by is italicized in the Customer table heading.



## Searching for Customer Accounts

The Search frame is available at the top right of the Compass Shell.

Figure 5-3 The Search Option

You can search by:

- Panel,
- Receiver number,
- Selected Sort Option.

To search by **Panel** name, perform the following steps:

Step	Action
1	From the Panel list, choose the panel.
2	If all revisions of that panel type are required, select All Revs.
3	Click <b>Search</b> . The customer table is refreshed showing only the search results.
4	To view all accounts, click <b>All Accounts</b> .

To search by **Receiver number**, type the receiver number and click **Search**.

The third search option based on the sort option that you selected, as described in [The Sort By Option](#).

Example: If you have selected the sort option as 'Panel Phone', the search option would be 'Panel Phone Begins with', as shown in Figure 5-3 above. Type the beginning numbers of the Panel phone and click **Search**, to display the search results.

## 4.6 Purging History Data

An operator with administrative rights can delete history data from the Compass database using this utility. This history data is viewed from the History screen within the Panel Modify screen of each account.

To access the Purge History screen, perform the following steps:

Step	Action
1	Click <b>Tools</b> on the Compass Shell screen menu bar.

- 2 Click **Purge History**.  
The following dialog box is displayed:



- 3 Select **All Accounts** or **Specific Receiver / Account**, and the **Date Range**.

**All Accounts** The operator can purge the history for all the accounts in the date range selected.

**Specific Receiver / Account** Type the Receiver number and Account number in the text boxes provided.

“All History Data” is also enabled in the date range, allowing you to purge all the history data of that particular account.

- 4 Click **Purge History**. All the history data for the selected period, for the selected accounts is purged.
- 5 Click **Close** to close the dialog box.

## 4.7 Purging Event Logs

To access the Purge EventLogs screen, perform the following steps:

Step	Action
1	Click <b>Tools</b> on the Compass Shell screen menu bar.

- Click **Purge EventLogs**.  
The following dialog box is displayed:

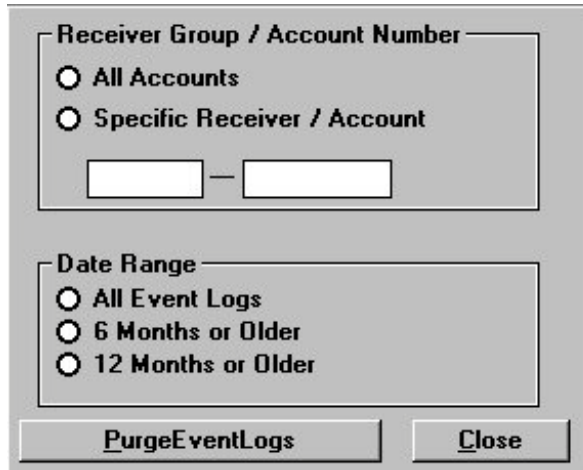

- Select **All Accounts** or **Specific Receiver / Account**, and the **Date Range**.

- All Accounts**      The operator can purge the Event Log data for all the accounts in the date range selected.
- Specific Receiver / Account**      Type the Receiver number and Account number in the text boxes provided.

- Click **Purge EventLog**. All the Event Log data for the selected period, for the selected accounts is purged.
- Click **Close** to close the dialog box.

## 4.8 Renaming Receiver Group

To rename a receiver group, perform the following steps:

Step	Action
1	In the Compass Shell screen menu, click <b>Tools&gt; Rename Receiver Group</b> . The following screen is displayed:



- 2 Type the **Old Receiver** name and the **New Receiver** name in the appropriate text boxes.
- 3 Click the **Check Conflicts** button to ensure that the change does not duplicate a Receiver Group / Account number information.
- 4 If there are no conflicts, click **Rename Receiver** to change the Receiver Group name.
- 5 If there are conflicts, reassign the accounts that do not conflict with the new Receiver Name by selecting the **Rename Accounts Not In Conflict** box.
- 6 Click **Exit** to return to the Customer screen.

## 4.9 Exporting and Importing Accounts

You can copy a single account from one computer to another. This facility is especially useful for technicians at a job site, working with laptops.

- When exporting an account, copy the account from your current Compass database to a drive on a network or to a floppy disk.
- When importing an account, copy the account from a network drive or a floppy disk to your current Compass database.

### Exporting an Account

To export an account, perform the following steps:

Step	Action
1	Select an account from the Customer grid in the Compass Shell screen.
2	From the menu bar, select <b>Tools&gt;Export Account</b> . A window titled " <b>Save Exported Account As</b> " is displayed.

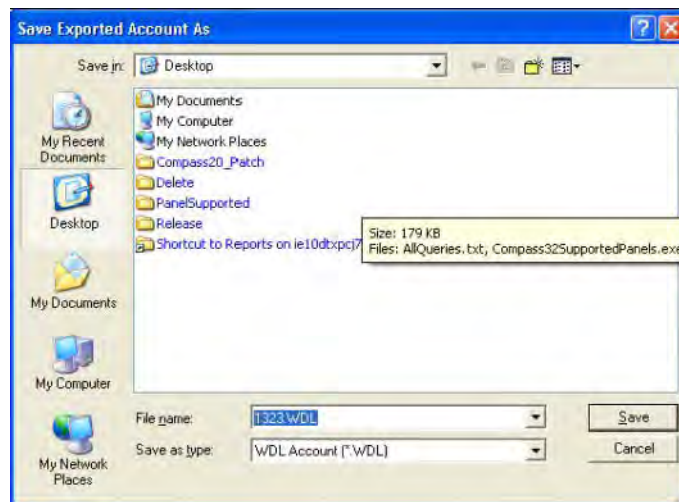

- 3 Type a file name. Ensure that the name has an extension of ".wdl".
- 4 Select the drive to which the file must be copied.
- 5 Select the directory on that drive to which the file must be copied.

- 6 Click **Ok**.

## Importing an Account

To import an account, perform the following steps:

Step	Action
1	Select an account from the Customer grid.
2	On the Customer Account screen, select <b>Import Account</b> under Tools on the main menu bar. A window titled " <b>Select File to Import an Account</b> " is displayed.

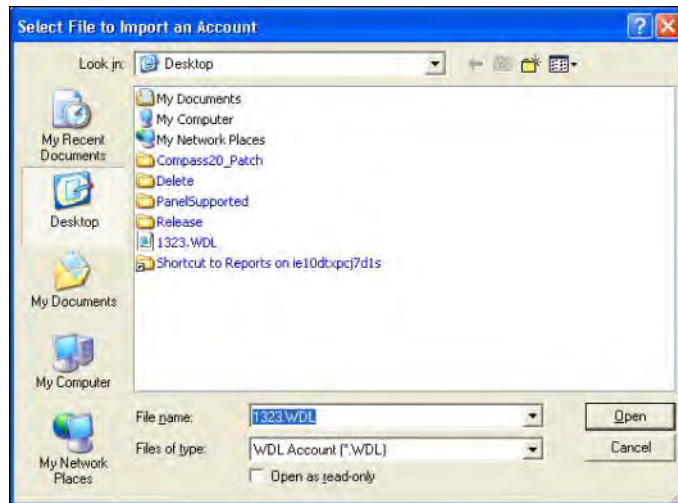

- 3 Select the drive where the file to be copied is located.
- 4 Select the directory on that drive where the file to be copied is located.
- 5 Select the file with the account to be copied.
- 6 Click **Ok**.  
The imported account appears in the Customer grid in the Compass Shell screen.

## 4.10 Customizing the Customer Account Screen

You can customize the way the Customer grid displays accounts.

### Making Changes to the Layout

To change the **column width**, click the right edge of the column and drag to the left to narrow it, or to the right to widen it.



To change the **column position**, click a column heading and drag it to the column position you want. For example, to move Zip Code after Panel Name, click Zip Code and drag the mouse to the required position.

The two red arrow heads indicate the new position of the column.

First Name	Zip Code	Business	Panel Name	Panel Phone
Gordon		Architect	4110-1	Zip Code
Michael		Textiles	4110XM-7	

## Saving the Changes

To save the layout and the Search Options, perform the following steps:

Step	Action
1	Click <b>Options</b> on the Customer screen menu bar.
	
2	Click <b>Save &amp; Use</b> Layout. You will see it selected the next time you go to the Options Menu. Every time the option is selected, it toggles on or off. You can save your screen layout when you exit the Downloader application by keeping the option checked.
3	To restore the original customer grid layout, click the Restore button  located in the upper-left corner of the grid.

## 4.11 Viewing Unattended Jobs

Click **Unattended Jobs** in the customer screen to view the status of all the scheduled jobs.

On clicking **Unattended Jobs**, the **Viewer** screen is displayed:

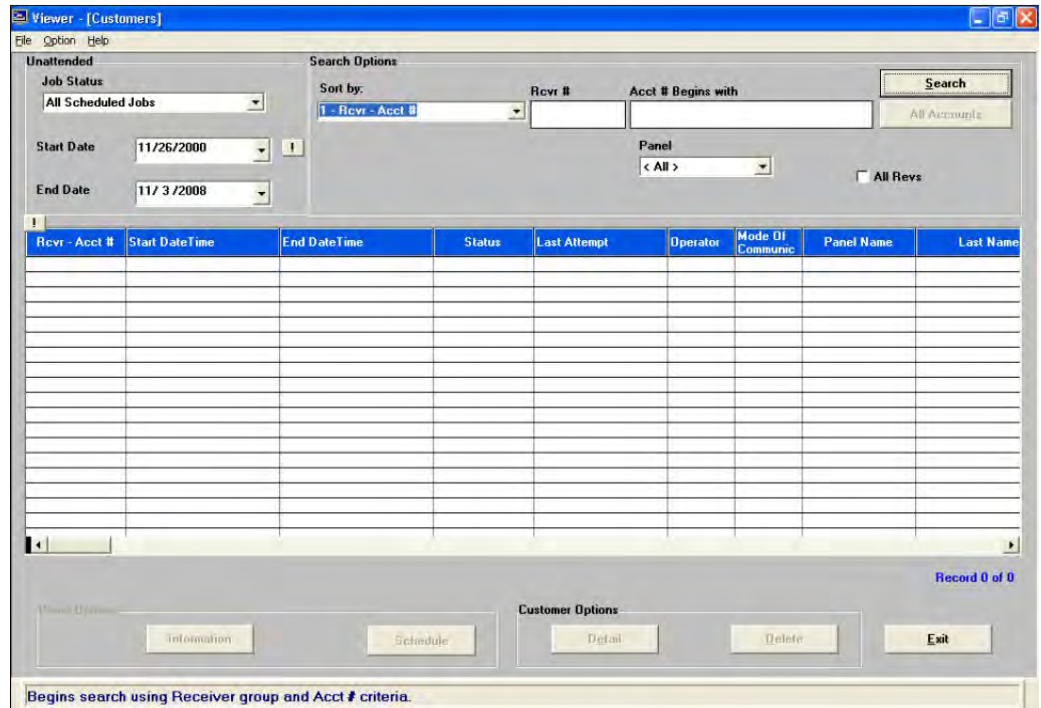

**Figure 5-4 Viewer [Customers]**

You can see the status of all the assigned tasks in the displayed table. It also shows the details like start date and time, the end date and time, the panel name, and number of retries (Retry Count). The search options allow you to search for details of particular revisions or panels.

The third search option is based on the sort option that you selected. In the **Viewer [Customers]** screen, the sorting is done based on Account number. Hence you have a search option “**Acct # begins with**”.



**REFERENCE- INTERNAL**

For more information on Unattended jobs and other features refer to [7.1 Unattended Operation](#).

## 4.12 Defaulting Panel Information

This option allows you to replace the current panel information with default values.

To load the panel information with default values, perform the following steps:

Step	Action
------	--------

- 1 Click **Default** at the bottom of the customer screen. A message box is displayed.



- 2 Click **OK** to update the panel information with the default values or click **Cancel** to cancel the operation.

## 4.13 Modifying Panel Information

This option allows you to edit the current panel information.

To modify the panel information, perform the following steps:

Step	Action
1	In the customer screen, highlight the account whose panel information is to be modified.
2	Click <b>Modify</b> at the bottom of the customer screen.
3	The corresponding panel application screen (16 bit or 32 bit application) for the panel is displayed.



### TIP

Alternatively, you can double-click the selected customer row to display the corresponding panel application screen.

## 4.14 Scheduling Jobs

You can use this option to schedule the unattended communication tasks.

To schedule the jobs, perform the following steps:

Step	Action
1	Select the customer row from the customer grid.
2	Click the <b>Schedule</b> button located in the <b>Panels options</b> area of the screen.
3	The corresponding Ademco, ADT, Apex or FBII scheduler screen is displayed, which is used to schedule the jobs.



### REFERENCE- INTERNAL

For more information, refer [Scheduling Ademco Unattended Jobs](#), [Scheduling FBII Unattended Jobs](#), and [Scheduling Apex Unattended Jobs](#).



## 4.15 Viewing Event Logs

You can use this option to view the log form which displays the previously uploaded event logs for the panel. The event log form displays the list of all the commands that have been previously executed in the interactive mode.

To view the event logs, perform the following steps:

Step	Action
1	Select the customer row from the customer grid.
2	Click the <b>View Log</b> on the screen. If there are no records, the following message box is displayed.



Or

If there are event log records, the **View Event Log** screen is displayed.

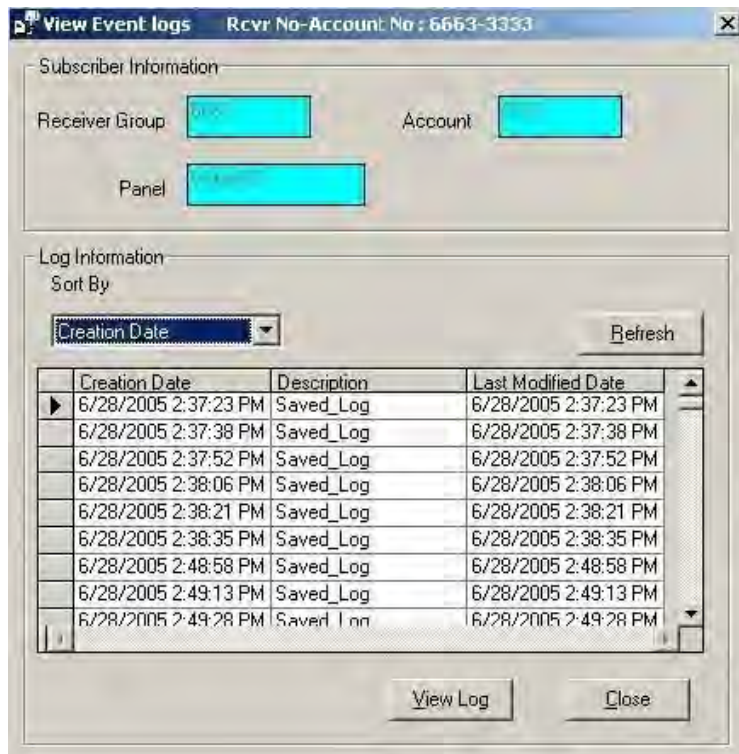

### TIP

Alternatively, enter the interactive communication modules for the specific accounts and click **Event Log** button in the bottom tool bar, to view the event logs.

## 5. Control Panel Information

### 5.1 Alarm Control Programming

Control panels belonging to Ademco, FBII, and Apex protocols are available for use with the Compass commserver. Most of the panels that legacy Compass 16-bit supports, are supported in Compass 2.0.



#### REFERENCE- INTERNAL

For more information on panels supported by the different versions of Compass, refer to [1.4 Viewing a List of Panels Supported by Compass 2.0](#).

To access the Alarm Control Programming (Panel Edit) screens:

- Double-click the highlighted customer account row in the Customer screen of the Downloader.
- Alternatively, highlight the customer account row and click **Modify** in Panel Options.

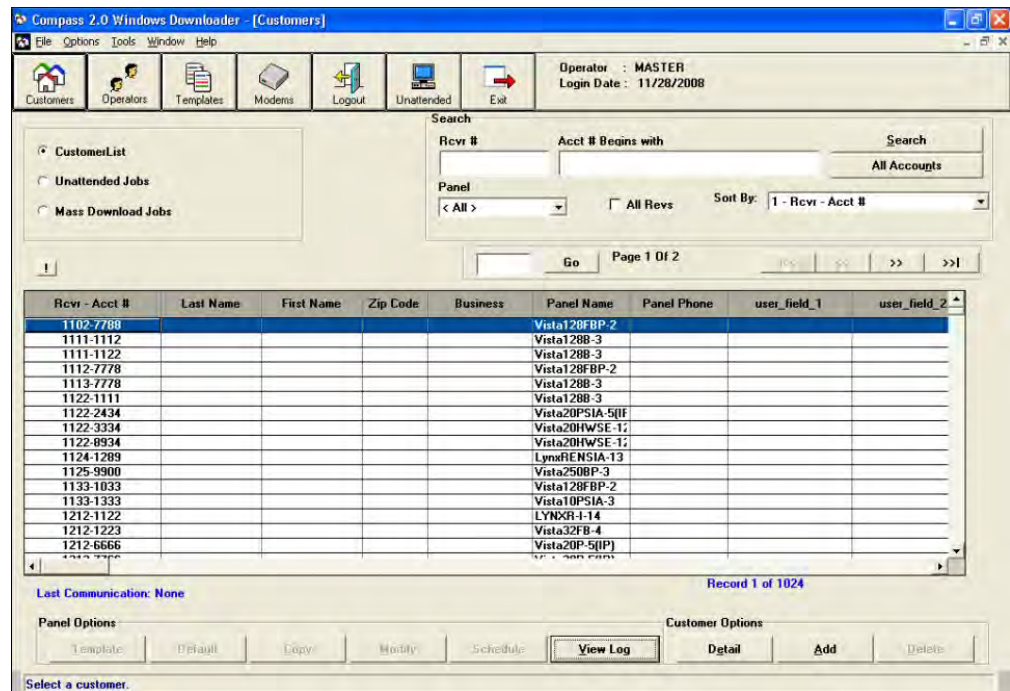

Figure 6-1 Compass 2.0 [Customers]

Based on the panel supported, the panel application for Compass 16, or the panel application for Compass 2.0 is displayed.

## 5.2 Panel Application for Compass 16

### Overview

A 16-bit panel screen, in general, includes the following layout:

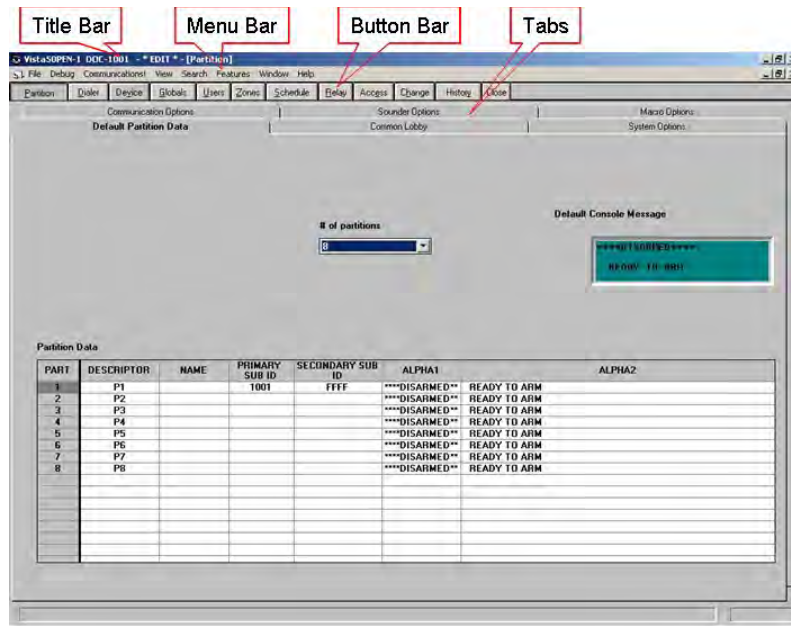

Figure 6-2 Control Panel

At the top of the screen is the **title bar**. It identifies the control panel type and revision, and the receiver/account number of the customer you selected. Under this is the **menu bar**. The options in the menu bar are not control panel-specific as they are Downloader operations.

### Menu Bar options

#### File

Option	Allows you to...
Save	Save the alarm control settings.
Print Setup	Select and set up the printer.
Print Programming form	Print a programming form that reflects the account's current Edit data.
Exit	Exit the application.

## Communications

Clicking Communications in the Panel menu bar takes you to the Compass Communications screen. It allows you to upload or download information to the panel, providing the ability to arm, disarm, retrieve status, bypass zones, and send messages.



### ATTENTION

The availability of these options is dependent on the panel being connected to, and the panel programming options.

## View

The View modes enable you to see different versions of a control panel's E2 data. You can view the values saved in the Downloader, values uploaded from the control, default values, or an unsaved current Edit value. The screen in view is indicated in the upper-right corner of the title bar.

Option	Allows you to...
Current Edit	View the changes just made (not saved yet) to the control programming.
Upload	View the data last uploaded from the alarm control.
Saved	View the previously saved data.
Defaults	View the programming defaults for a control panel. (Some, like the Lynx family panels, have multiple default options available.)

## Search

This option allows you to search for a specific programming option by field number or name. To do this, select **Search** from the Panel Edit screen. The following screen is displayed:

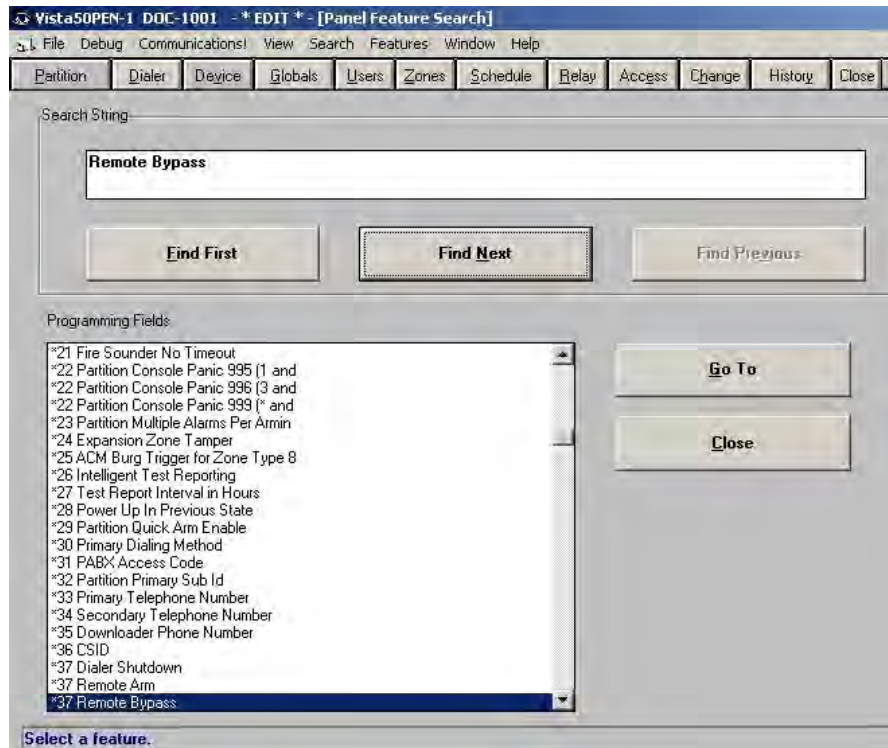

Figure 6-3 Panel Feature Search

To search for a particular option, perform the following steps:

Step	Action
1	Type the programming field number or part of the field name that you are looking for.
2	Click the <b>Find First</b> button. If you want to go to the field in the programming screens, click the <b>Go To</b> button. Compass takes you to the appropriate screen and indicates the field with a red arrow.
3	If <b>Find First</b> did not bring you to the option you wanted, press <b>Find Next</b> to go to the next option matching the criteria. Use <b>Find Previous</b> to go back to an earlier option.



**TIP**

Double-clicking the programming field also takes you directly to the appropriate screen.

**Features**

This menu displays the same options as those on the button bar, with the hot key details.

**Window**

Presents normal Windows features, such as cascading and arranging screens, and displays screens currently open.

**Help**

Select **About** to view the version and release date of the Compass Database and of the Panel Edit module for the panel you are modifying.

**Programming an Alarm Control**

From the Downloader customer screen get to the panel screen as explained in the Alarm Control Programming overview. The Panel screen varies according to the features of the control panel selected.

To program the panel, perform the following steps:

Step	Action
1	Select the section (Partition, Dialer, Zones) to program from the button bar (refer to <a href="#">Figure 6-2 Control Panel</a> ).
2	Type the control panel programming information.
3	When you complete programming, select <b>Close</b> . The <b>Save Changes</b> screen is displayed:

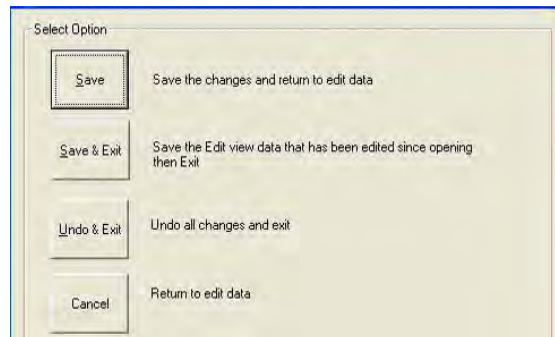

- 4 To save the programming information, click **Save**. To close without saving, click **Undo**. To return to the Panel Edit screen without saving, select **Cancel**.

**5.3 Panel Application for Compass 2.0**

The panel application designed for Compass 2.0 is a new and improved version of the earlier 16-bit panel applications. Feedback and comments from users were used for designing the screens.

As against the functionality-centric navigation of the earlier panels, the new design offers a partition-centric navigation, besides a more logical approach to configuration.

## Overview of the panel

The panel application designed for Vista250FBP is taken as an example in this user guide. The design of all other panel applications follows similar lines.

The panel application has a left navigation bar and a right pane that shows the corresponding user interface controls.

The left navigation bar contains the listing of different configuration groups. Click the required group to display the screen in the right pane.

The partition screen is displayed in Figure 6-4. The application enables you to configure all the attributes related to a partition on a single page while with the previous panel you had to navigate to different tabs to program a single partition.

You can also configure the zones, devices, users, and schedules for that partition without navigating outside of the Partition tab.

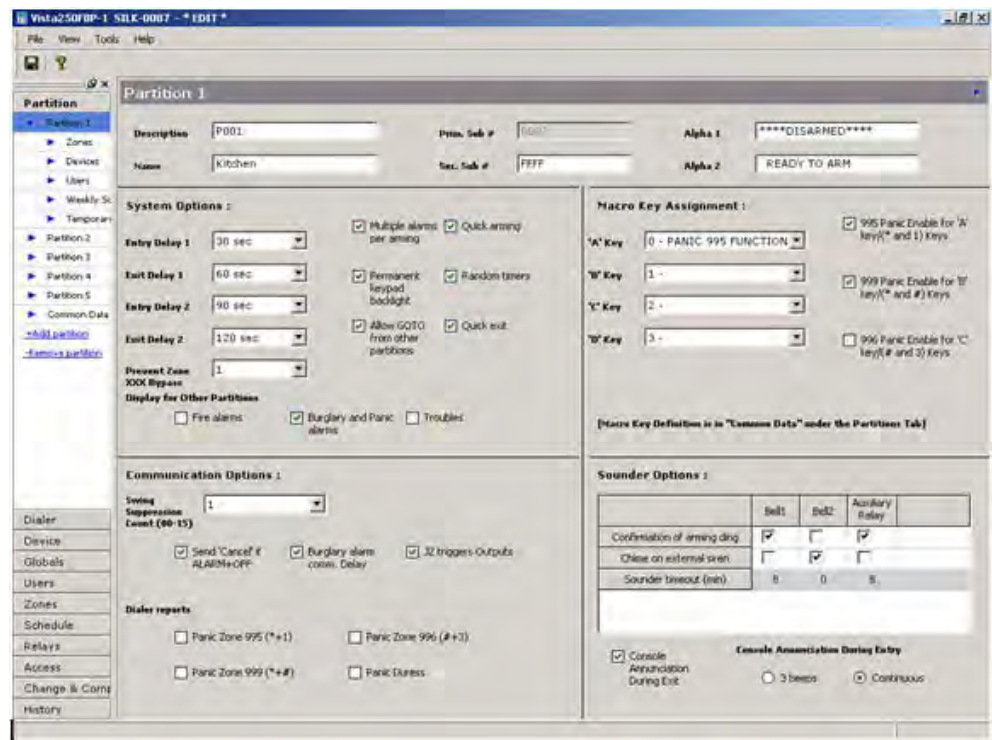

Figure 6-4 Panel Application for Compass 2.0

### Navigation

The left pane is the navigation bar to the different configuration groups. To configure partitions, globals, dialer properties and so on, click the relevant tab on the pane.

Sub-menus under the tabs for the different configurable screens for the particular group facilitate easy navigation.

You can configure associated zones, devices, users, and schedules by selecting the configuration group under each partition. For example, to configure the zones for partition 1, click the **Zones** tab under **Partition 1** in the left navigation bar. The configurations that you select in this tab are applicable exclusively to partition 1.



Figure 6-5 Left Navigation Bar



## The Menu bar

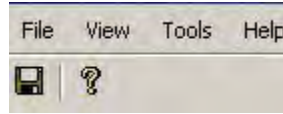
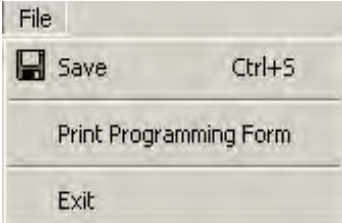
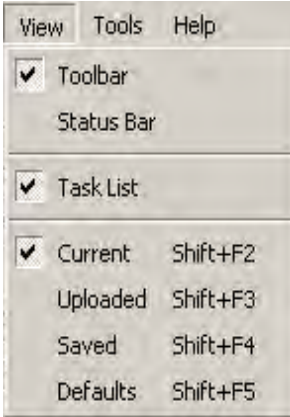
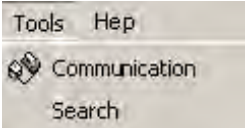
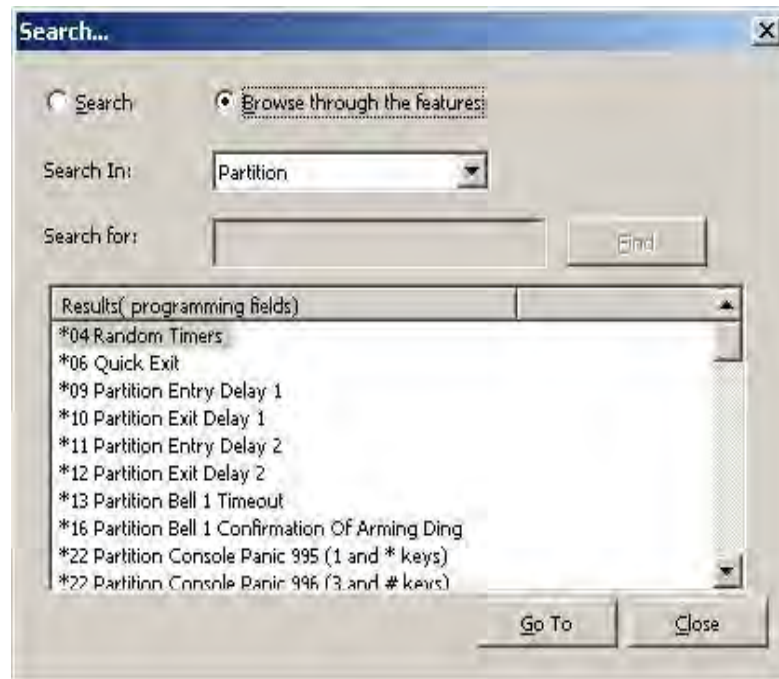
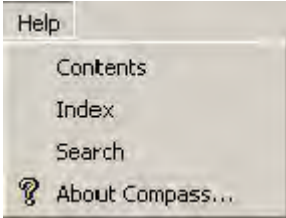

Figure 6-6 Menu

Menu Option	Purpose
<p data-bbox="423 575 467 600">File</p> 	<p data-bbox="1008 575 1369 632">The File menu offers the following submenu options:</p> <ul data-bbox="1008 642 1393 1010" style="list-style-type: none"> <li>• <b>Save</b> – To save changes to data.</li> </ul> <p data-bbox="1045 722 1304 779">The toolbar includes the shortcut.</p> <ul data-bbox="1008 789 1393 1010" style="list-style-type: none"> <li>• <b>Print Programming Form</b> - To launch the Print dialog which can be used to Print the account's current configuration data</li> <li>• <b>Exit</b> – To exit the application</li> </ul>
<p data-bbox="423 1037 483 1062">View</p> 	<p data-bbox="1008 1037 1393 1094">You can view the following from the View menu:</p> <ul data-bbox="1008 1104 1393 1493" style="list-style-type: none"> <li>• The <b>Toolbar</b> below the menu bar</li> <li>• The <b>Status Bar</b> at the bottom of the screen</li> <li>• The <b>Task List</b> on the left pane</li> <li>• The <b>Currently</b> edited data (onscreen data)</li> <li>• The <b>Uploaded</b> data</li> <li>• The <b>Saved</b> data</li> <li>• The <b>Default</b> data</li> </ul>
<p data-bbox="423 1568 483 1593">Tools</p> 	<p data-bbox="1008 1568 1393 1625">The Tools menu offers the following sub-menu options:</p> <ul data-bbox="1008 1635 1252 1696" style="list-style-type: none"> <li>• Communication</li> <li>• Search</li> </ul>

Menu Option	Purpose
Communication	This option launches the communication screen.
Search	The Search feature allows you to quickly find a feature and its configuration details in the application. Search from the existing list of features by selecting the Browse through the features option, and select the feature group name from the Search In dropdown. To search through all the groups at once using keywords, select the Search option, select 'All' in Search In, and type the feature in Search for. Click Find. The results are displayed in the Results pane below. To go to the feature, double-click the searched feature, or select the feature and click Goto. Click Close to close the Search dialog box.



	Menu Option	Purpose
Help		<p>The Help menu launches the Compass Help file. You can search by Index, Contents, or search keywords.</p> <p>It also launches the About box which gives the version details of the Compass Downloader application.</p>

### Save Changes Dialog

The **Save Changes** window is displayed when Compass is closed by clicking the 'X' button. Other functions can be performed by clicking the following buttons.

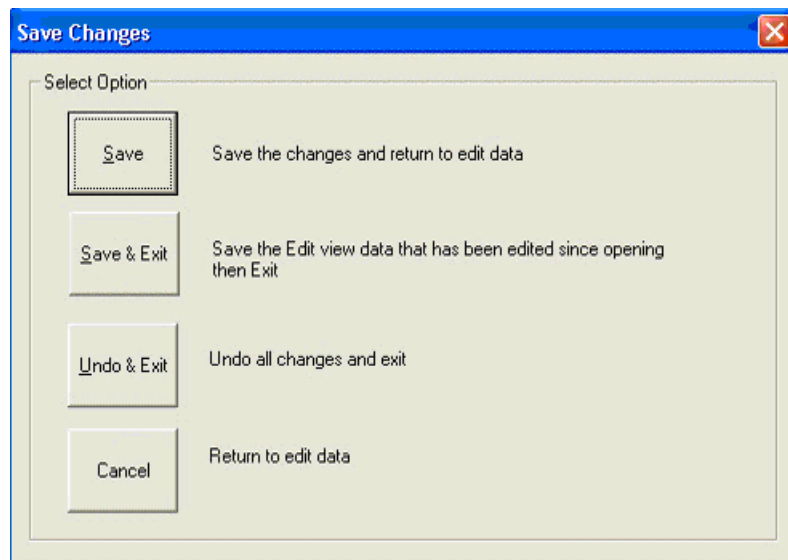

- **Save** - Modified values in PA will be saved and return back to the edit view.
- **Save and Exit** –Modified values will be saved and exit.
- **Undo and Exit** – Modified values in PA will not be saved and the following message box will be popped up.

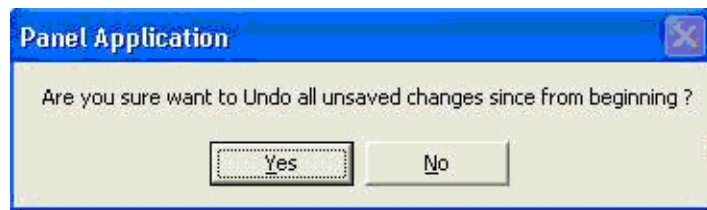

If you select **Yes**, Undo operation will occur and the application will exit.

If you select **'No'**, the application will come back to the edit view.

## Configuration Groups

Following are the configuration groups to be programmed in the panel:

- Partitions
- Globals
- Dialer
- Device
- Users
- Relays
- Zones
- Access
- Schedules

A brief description for each of these groups follows.

## Partitions

Partitions allow you to break up a large area into smaller sections. This feature is useful to disarm certain areas while leaving other areas armed, or to limit access to certain areas to specific individuals.

## Adding and Removing partitions

To add or remove partitions, perform the following steps:

Step	Action
1	Click the Partition tab in the left navigation bar. The different tabs under Partition are displayed.

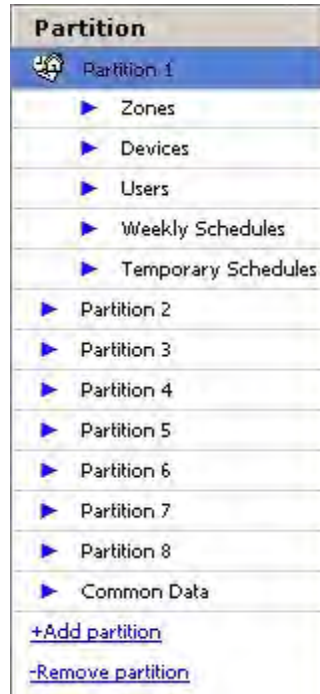

- 2 Click [+Add Partition](#) to add a new partition.
- 3 Click [-Remove Partition](#) to remove the last added partition.

## Configuring Common Data

Information regarding common lobby, and the description and definition of macro commands is common across the partitions. Configure these from the **Common Data** tab.

### Common Data

**Select The Partition To Be Common**  
**Lobby**  
 2 - P2 Kitchen

**Partition : Arming And Affect Relationship**

Partition	Affects Lobby	Arms Lobby
Partition #1 Hall	<input checked="" type="checkbox"/>	<input checked="" type="checkbox"/>
Partition #2 Kitchen	N/A	N/A
Partition #3 Lobby	<input checked="" type="checkbox"/>	<input checked="" type="checkbox"/>
Partition #4 Bedroom1	<input type="checkbox"/>	<input type="checkbox"/>
Partition #5 Bedroom2	<input checked="" type="checkbox"/>	<input checked="" type="checkbox"/>
Partition #6 Reading Room	<input type="checkbox"/>	<input type="checkbox"/>

◀ ▶

**Macro Descriptors And Definitions**

MACRO#	DESCRIPTION	DEFINITION
1	Quick Arm	1234#2
2	Light on	1234#34
3	Light off	1234#45
4		

Figure 6-7 All Partition Common Data

## Configuring Partition Specific Data

Configure the data specific to each partition in the individual partition screen.

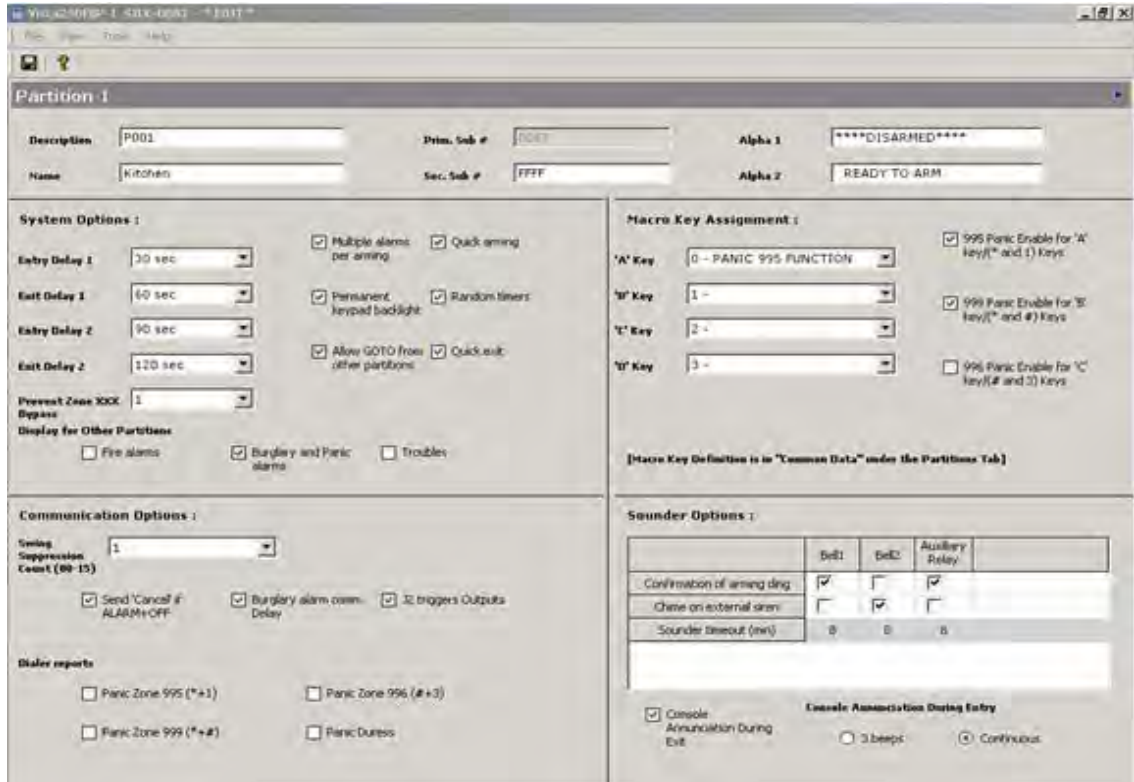

Figure 6-8 Partition Specific Data

You have to configure the following for each partition:

Data	Allows you to...
General information	Specify a description, name, the primary and secondary subscriber Ids, and the Alpha descriptors.
System Options	Specify system options including the Entry and Exit delays allowed by the system, the display characteristics, the general rules for arm, disarm, and bypass, and enabling of certain specialized features and rules.

Macro Key Assignment	<p>Select Macro Key Assignments from the drop-downs. A Macro or Speed Key command is a series of keystrokes stored in the system memory and activated when a programmed lettered key is pressed. Each Speed Key command can include 32 keystrokes. Generally four macro commands (A, B, C, and D) are supported. However, this varies from panel to panel.</p> <p>Typical macro functions include:</p> <ul style="list-style-type: none"><li>• Arming sequences that involve first bypassing certain zones before arming</li><li>• Seldom-used but repeatable sequences</li><li>• Relay activation sequences</li></ul> <p>Lettered keys A, B, C, and D are assigned a specific macro definition by entering a Speed Key number.</p>
Sounder Options	<p>Indicate the sound settings for the bells and auxiliary relay.</p>
Communication	<p>Specify the communication delays and swing suppression count.</p>
Dialer Reports	<p>Indicate the zones for which the reports are to be sent.</p>



## Dialer

The settings for connection to panel, and communication are configured in the dialer. This includes the downloader phone numbers, panel phone numbers, communication channel details, and devices information.

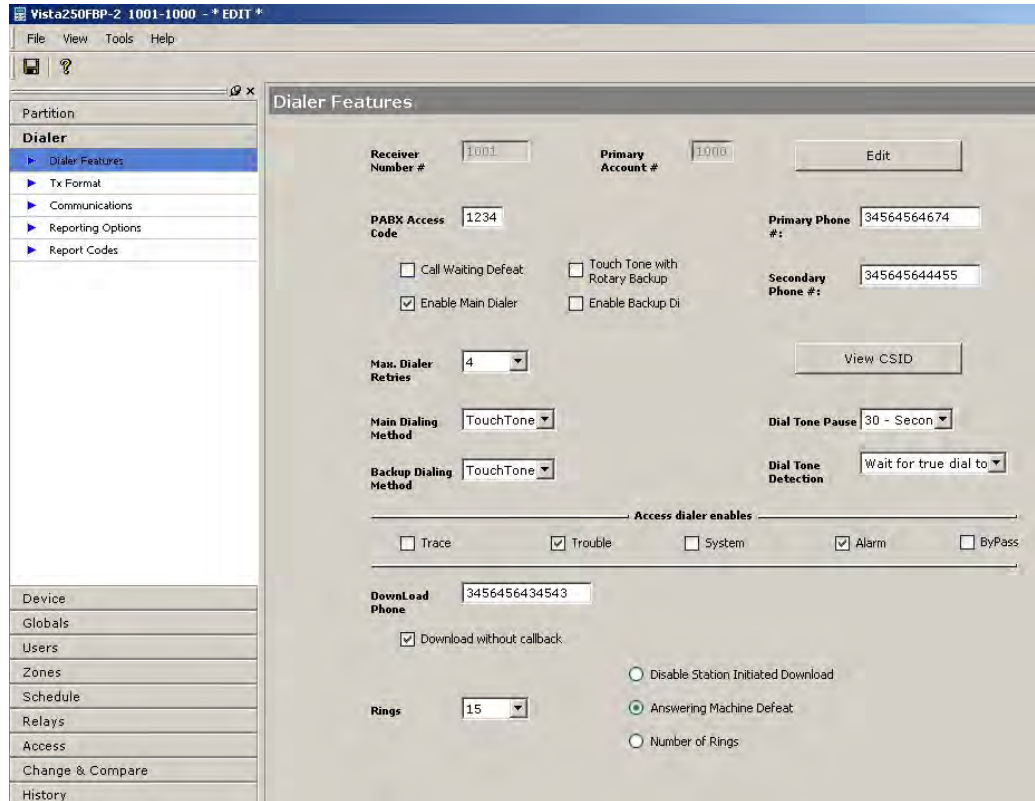

Figure 6-9 Dialer Features

Options	Allows you to...
Dialer Features	Configure the Receiver-Account#, CSID, PABX, ring count, primary and secondary phone numbers dialing methods, download information, and max dialer retries.
Tx Format	Configure the transmission format and speed, select reports, and select system non-alarm codes.

### Tx Format

**Primary Tx Format**

2. Ademco HI

**Primary Speed**

0. Ademco

Checksum Verify - Primary

**Radionics or Sescoa Transmission:**

0-Radionics

**Reports for Primary**

Alarms

Restores

Bypasses

Troubles

Open/Close

Low Battery/AC Loss/ Test

**Secondary Tx Format**

3. Ademco Express

**Secondary Speed**

0. Ademco

Checksum Verify - Secondary

**Load Transmission Default values:**

0-No Default Format

**Reports for Secondary**

Alarms

Restores

Bypasses

Troubles

Open/Close

Low Battery/AC Loss/ Test

**System Non Alarm Code**

	First Digit	Second Digit
CLOSING	0	1
OPENING	2	5
LOW BATTERY	1	2
LOW BATTERY RESTORE	0	0
AC LOSS	D	E
AC RESTORE	C	F
TEST	0	0
POWER-UP	0	0
CANCEL	0	0
PROGRAM TAMPER	0	0
ARMED STAY	0	0
TIME/DATE SET & EVENT LOG RESET	0	0
EVENT LOG 50% FULL & 90% FULL	0	0
EVENT LOG OVERFLOW	0	0
EXIT ERROR - USER REPORT	0	0
RECENT CLOSE	0	0
WALK TEST START	0	0
WALK TEST STOP	0	0
OFF-NORMAL	0	0

**Randomize AC Loss Reports**

Normal AC Loss Reporting

Randomize AC Loss Reporting Between 10-40 minutes

Randomize AC Loss Reporting Between 6-12 hours

Communications

Configure dynamic signaling options, reporting intervals, initiating time and day, and select zone type reporting restore.

### Communications

Enable Intelligent Test Reporting

Enable Dual Reporting

Cancel Verify

**Split Reporting:** 1-Alarm & Alarm Restore & cancels primary ,Others Secondary

**Test Report Interval In Hours (0000-9999)** 1000

**Initiation Day:** Monday

**Dynamic Signalling Delay** 1-15 seconds

**Dynamic Signalling Priority** 1-Long Range Radio First

**Restore Report Timing** 1-at Bell Timeout

**Initiation Time:** 05:00

**Zone Type Reporting Restore**

Entry/Exit 1     Entry/Exit 2     Perimeter     Interior (Follower)

Day/Night     24 Hr. Silent     24 Hr. Audible     24 Hr. Auxiliary

Fire w/o Verify     Interior Delay     Fire With Verify     Fire Waterflow

Fire Supervisory

Report Codes

Enable and disable the alarm, troubles, and bypasses for a set of zones. The options configured for a group of zones in the top pane are displayed for individual zones in the bottom pane. In the bottom pane only the report code (Rpt) column is editable. The report code field takes values from A-F and 1-9.

**Report Codes**

Find Zones: 100

Zones	Alarm Restore	Trouble	Trouble Restore	ByPass	ByPass Restore
1-16	0	1	2	3	4
17-32	5	6	7	8	9
33-48	0	0	0	0	0
49-64	0	0	0	0	0
65-80	0	0	0	0	0
81-96	0	0	0	0	0
97-112	0	0	0	0	0
113-128	0	0	0	0	0
129-144	5	6	7	8	9
145-160	0	1	2	3	4

**Report Codes**

Zone	Response	Description	Rpt	Alarm	Alarm Restore	Trouble	Trouble Restore	ByPass	ByPass Restore
1	22 - Disarming	balcony	10	10	-	10	20	30	40
2	9 - Fire Without Verification	room1	20	20	-	10	20	30	40
3	3 - Perimeter	room2	30	30	-	10	20	30	40
4	3 - Perimeter	terrace	40	40	-	10	20	30	40
5	3 - Perimeter	lawn	50	50	-	10	20	30	40
6	3 - Perimeter		60	60	-	10	20	30	40
7	10 - Interior w/Delay		70	70	-	10	20	30	40
8	3 - Perimeter		80	80	-	10	20	30	40
9	0 - Disabled		10	10	-	10	20	30	40
10	0 - Disabled		20	20	-	10	20	30	40



**TIP:** The **Find Zones** feature helps you find a zone quickly. Type the zone number that you are looking for, and press Enter. The row corresponding to the zone number is highlighted.

Reporting Options

Configure the pager details and the reports that go out from specified partitions to specified pager numbers.

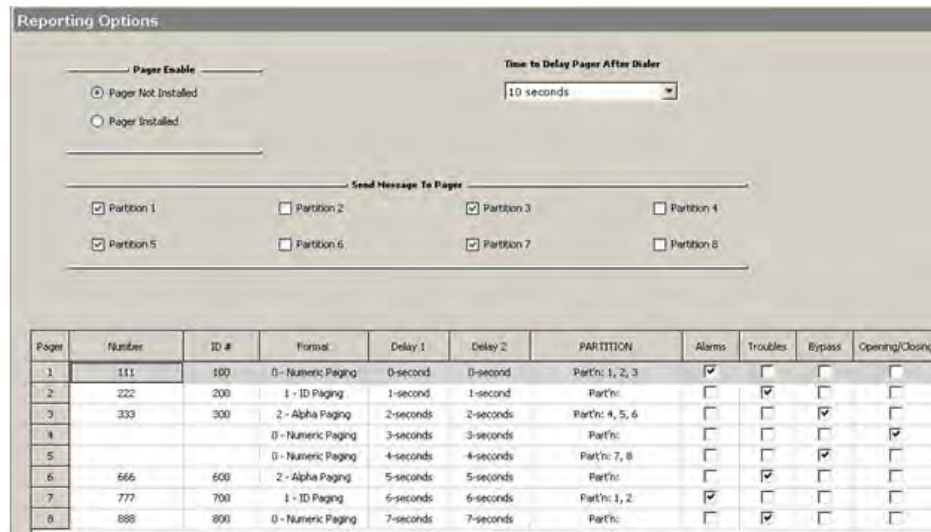

## Device

The details of all devices connected to the panel are configured here.

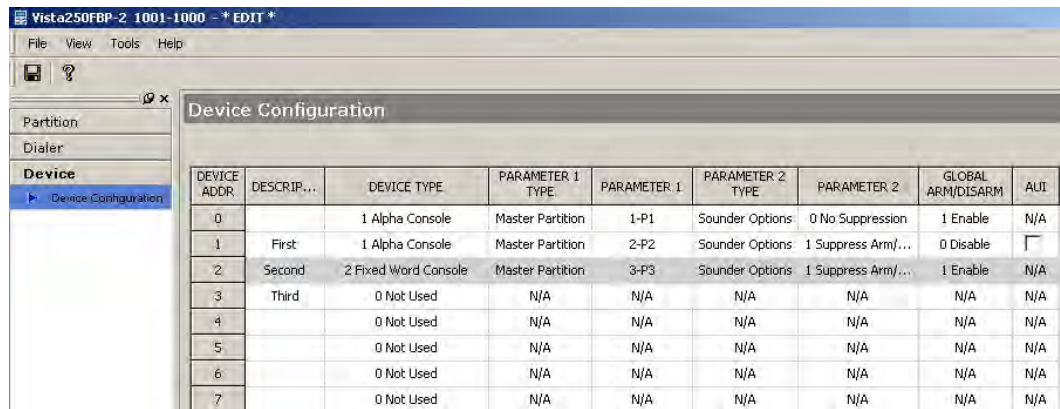

Figure 6-10 Device Configuration

## Globals

Set the global System options, RF Options, Event Log options, Fire options, Sounder options and Remote access options in this screen.

**Figure 6-11 Globals - System Options**

The settings you select here are common across the panel.

Options	Allows you to...
System Options	Set some common system options.
RF Options	Set RF options. Use an RF button-type transmitter to provide entry or exit for several doors. One button controls one door. A button can be used to provide access or egress due to a panic or duress condition. An RF transmitter is used with a remote switch to provide exit in case of a fire alarm.

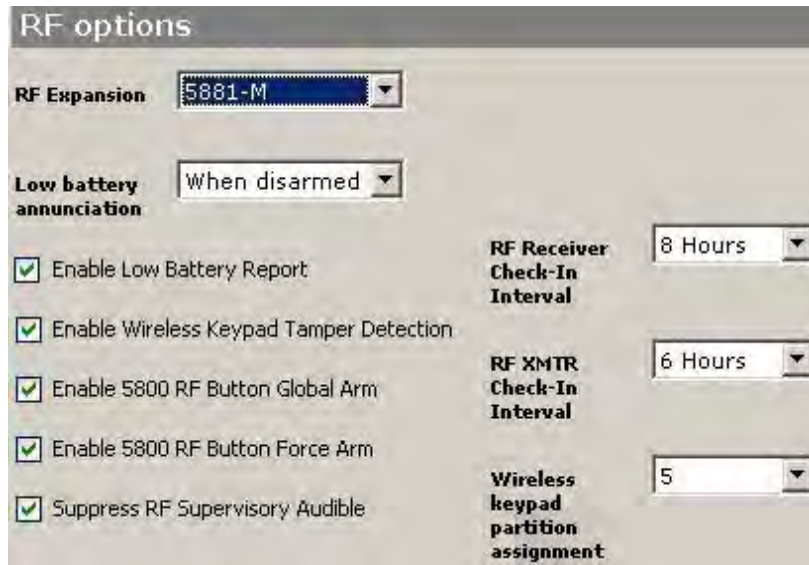

Event Log Options

Set Event log options – options for LRR, time format, and printer.

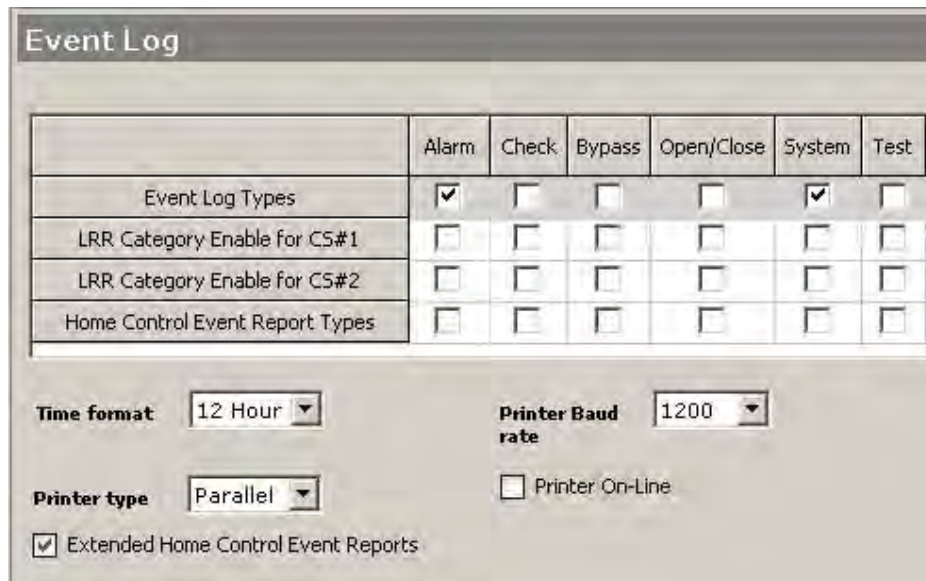

Fire Options

Set fire options – bypass fire zones, options for waterflow supervisory zones, fire display lock, and so on.

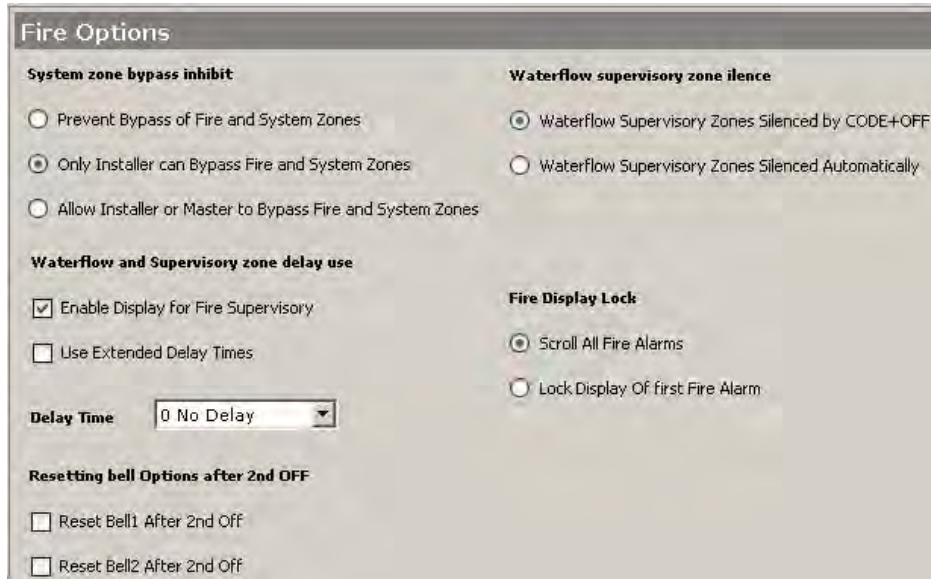

Sounder Options

Specify the sounder options for different situations.

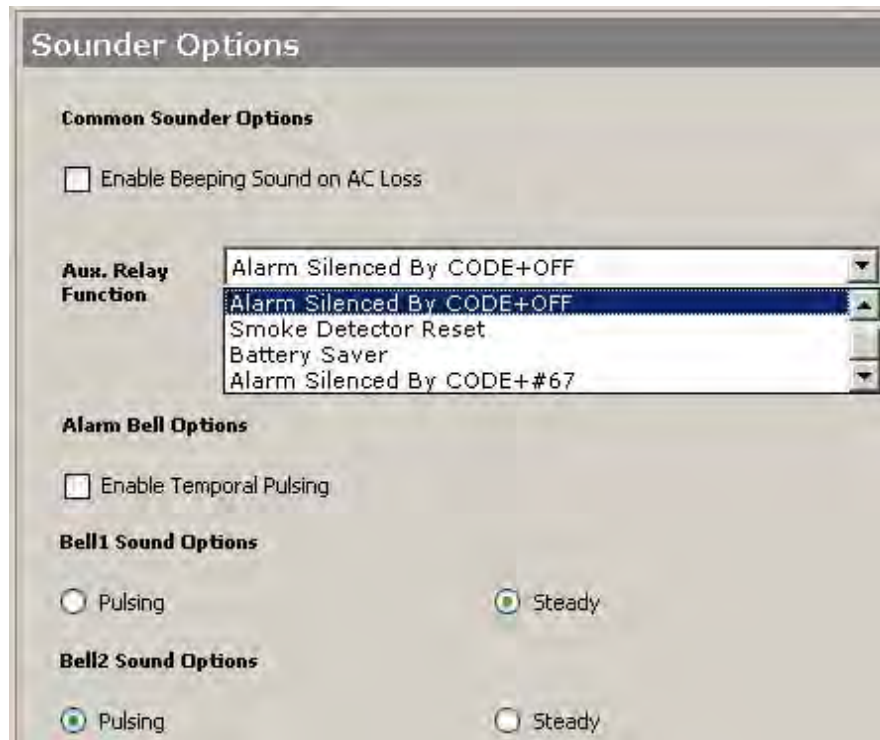

Remote Access Options

Set remote access options. The **Read Only Panel Remote Access Enables** gives you an indication of the commands that you are allowed to execute through the communication server.



**ATTENTION:** The enabling and disabling of the commands are done at the panel end. The user can only view the status here.



## Users

In this screen you can record details of the panel users such as user name, code, access group, and partitions that the user can access.



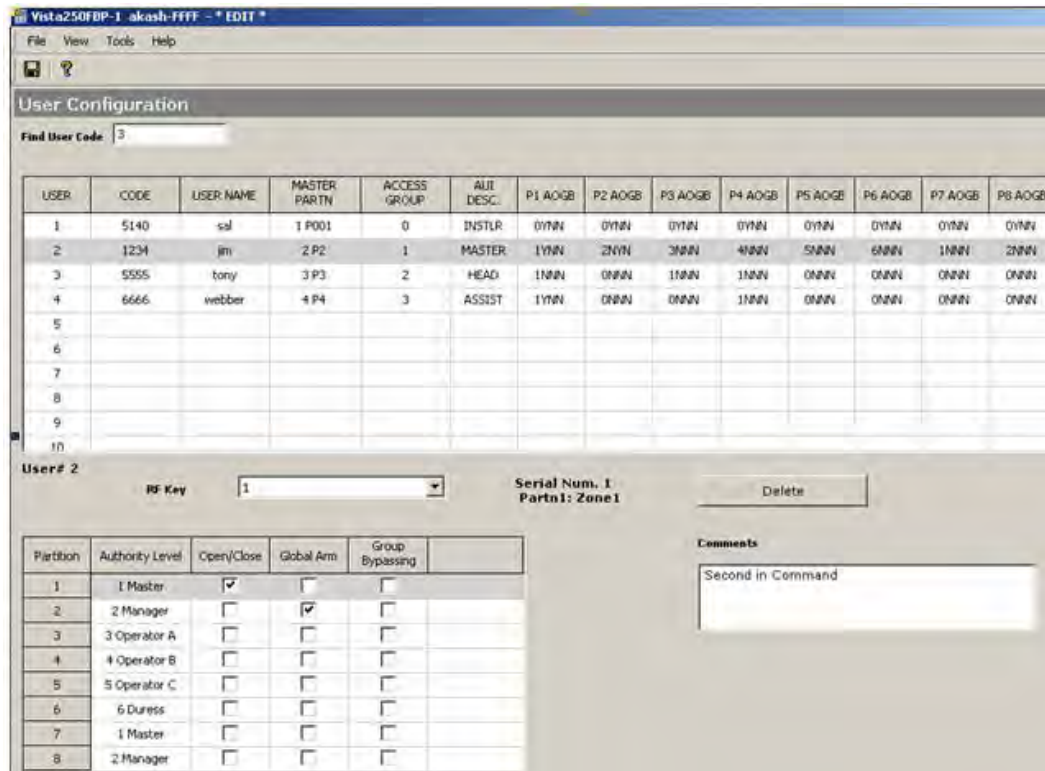

Figure 6-12 Users

## Zones

Zones, in the context of an alarm system, are individual sensors. If the alarm gets triggered, the system records the zones that were tripped, allowing you to know the exact point of action. Zones also help the monitoring station to know whether they should call the police or fire department upon an alarm. Each zone must be assigned to a partition.

## Zone Configuration

In this interface you can configure all details related to each zone, such as the response type, report codes, input type, partition, loop and serial numbers, associated devices, relays, access points, bypasses, tamper options, vent options, faults and so on.

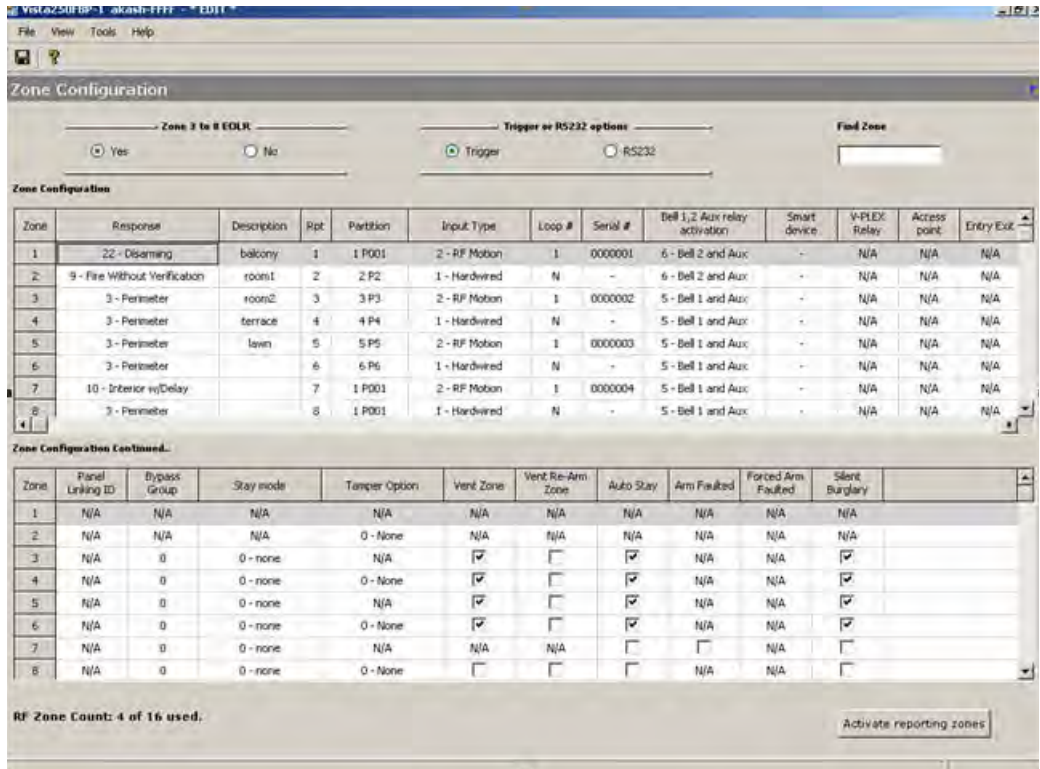

Figure 6-13 Zone Configuration

Click **Activate Reporting Zones** to initiate zone reporting.

### Cross-Zoning Pairs

The Cross-Zoning feature allows an alarm condition on any of the zones only when a combination of two zones is faulted within a specified period of each other. This prevents momentary faults from one of the zones causing an alarm condition. You can select a maximum of four pairs of cross-zones.

For example, for Vista250FBP Panel, you need to select a maximum of four pairs of cross-zones as shown in the following figure:

Cross Zone Pairs			
Zone pair	First zone	Second zone	
1	0	1	
2	2	3	
3	4	5	
4	6	7	

Figure 6-14 Cross-Zoning pairs

## Schedule

Under Schedule, you can configure the different time windows and schedules (weekly, holiday, temporary, limitation of access, and check-in), time-driven events, output device timers, and reports.

A time window is a period of time during which an event is permitted, or a specific time used to trigger an event.

Time windows are summarized as follows:

- Scheduled events are based on time windows, which are periods of time during which an event may take place.
- A time window is defined by a “Start” time and a “Stop” time.

The windows are shared by all partitions, and are used when programming time-driven events.



### TIP

Temporary schedule and Weekly Schedule can be configured through the partition screen also.

Parameter	Allows you to...
Time Windows	Configure the time windows.



**TIP:** There are two methods of configuring the time windows. One is through the time controls, where you specify the Start time and End time. The other **newly introduced feature** allows you to set your start and end times by clicking your mouse in the graphical control chart and dragging it to specify the time.

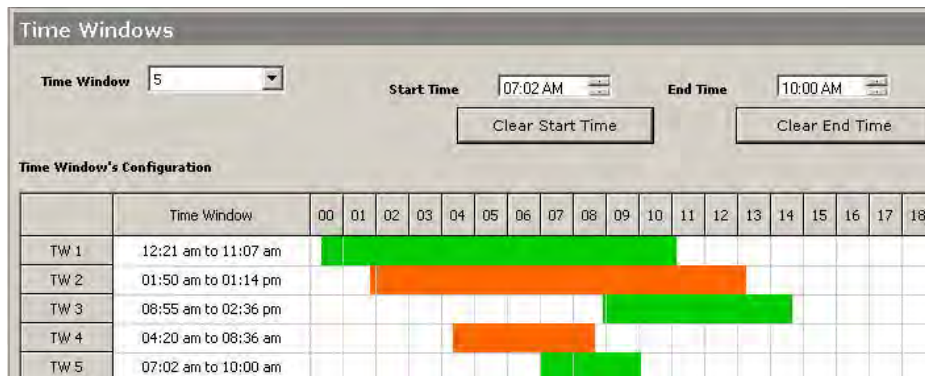

Weekly Schedules

Configure the delay, disarm, and warning periods, and auto arm times for each partition.

Each schedule for Open/close scheduling consists of one time window for openings and one time window for closings.

These time windows are represented graphically in the graphic control.

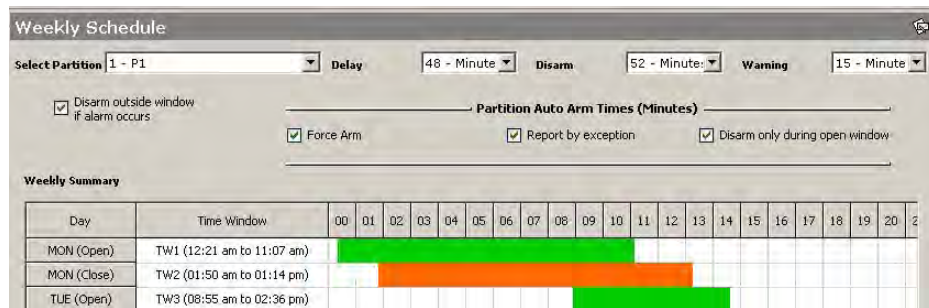

Holiday Schedules

Configure the holiday schedules for the partitions here.

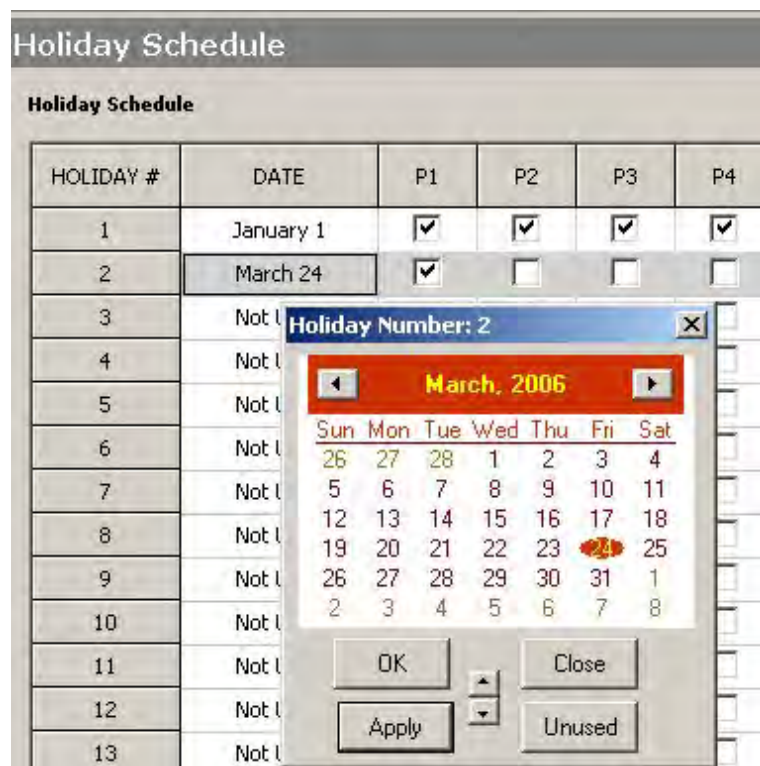

Temporary Schedules

Configure the temporary open and close start and end times for any partition, for any day.

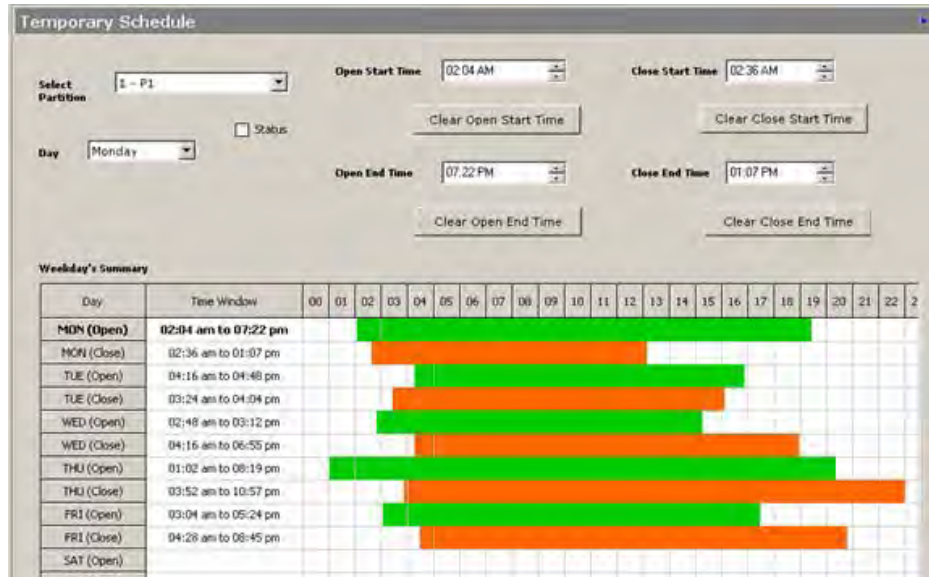

Limitation of Access Schedules

Configure the times at which certain windows are not accessible to certain groups.

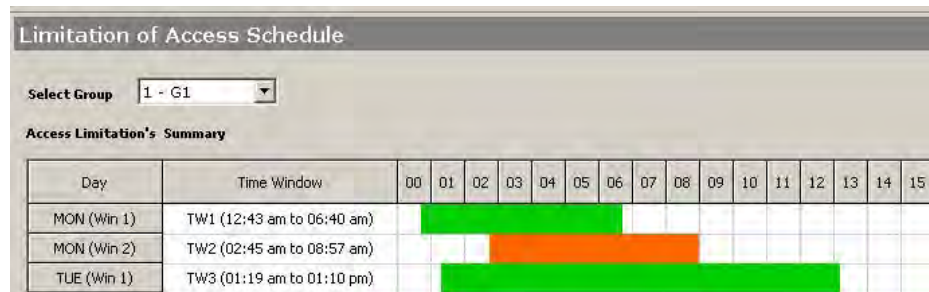

Time Driven Events

Configure time driven events here. Time-Driven Events are time-based triggers for certain actions. Note that Time-Driven Events are optional and are not required to operate the system.

**Time Driven Events**

Select Event: 1 - E1      Description: trigger\_alarm

Time Window: TW1 (12:43 am to 06:40 am)      Action on: 21 - Arm Away

Activation: 1 - Activated at Beginning of Time Window

Valid Days	
<input checked="" type="checkbox"/>	Monday
<input checked="" type="checkbox"/>	Tuesday
<input type="checkbox"/>	Wednesday
<input checked="" type="checkbox"/>	Thursday
<input checked="" type="checkbox"/>	Friday
<input checked="" type="checkbox"/>	Saturday
<input type="checkbox"/>	Sunday
<input checked="" type="checkbox"/>	Holiday

Specifier

Status	
<input checked="" type="checkbox"/>	Partition # 1 Kitchen
<input type="checkbox"/>	Partition # 2
<input checked="" type="checkbox"/>	Partition # 3
<input checked="" type="checkbox"/>	Partition # 4
<input type="checkbox"/>	Partition # 5
<input checked="" type="checkbox"/>	Partition # 6
<input type="checkbox"/>	Partition # 7
<input checked="" type="checkbox"/>	Partition # 8

**Output Device Timer**

Configure the on and off times for the different days for all the output devices used with the panel.

**Output Device Timer**

Clear Time

TIMER	DEVICE	ON TIME	OFF TIME	MON	TUE	WED	THU	FRI	SAT	SUN
1	1 -	12:02 AM	05:00 AM	<input checked="" type="checkbox"/>	<input checked="" type="checkbox"/>	<input checked="" type="checkbox"/>	<input type="checkbox"/>	<input type="checkbox"/>	<input checked="" type="checkbox"/>	<input checked="" type="checkbox"/>
2	2 -	09:00 AM	12:00 PM	<input checked="" type="checkbox"/>	<input checked="" type="checkbox"/>	<input checked="" type="checkbox"/>	<input type="checkbox"/>	<input checked="" type="checkbox"/>	<input checked="" type="checkbox"/>	<input type="checkbox"/>
3	***NO RELAY**	--:--	--:--	<input type="checkbox"/>	<input type="checkbox"/>	<input type="checkbox"/>	<input type="checkbox"/>	<input type="checkbox"/>	<input type="checkbox"/>	<input type="checkbox"/>

**Check-in Schedules**

Schedule check-in.  
 Example: If a quarterly check-in is scheduled, select the day of the month, and check-in time for each quarter.

Scheduling Reports

Select the reports that you want to activate.

REPORT CODES	1ST DIGIT	2ND DIGIT
EARLY OPENING	1	2
EARLY CLOSING	3	4
LATE OPENING	5	6
LATE CLOSING	7	8
NO OPENING	9	A
NO CLOSING	B	C
AUTO-ARM FAILURE	D	E
ACCESS SCHEDULE CHANGED	F	0

## Relay

Relays, used in conjunction with the control panel, are programmable switches that can be used for performing many different functions. They can be used for turning the lights ON and OFF, control sounders and doors, or for status indications. In this system, each device must be programmed as to how to act (ACTION), when to activate (START), and when to deactivate (STOP).

This control supports up to eight 4204 or sixteen 4204CF Relay Modules. Each 4204 Module provides four relays with Form C (normally-open and normally-closed) contacts. This means you can program up to thirty-two relays to activate and de-activate, as required. Each 4204CF Module adds two

additional style-Y supervised bell outputs to the system. If 4204CF Modules are used, only relays 1 and 3 on each module can be programmed. The other two relays (2 and 4) on each module are used for supervision purposes.

Configure the following under Relay:

Options	Allows you to...
Relay Timeout options	Configure the long and short timeout for each of the access control relays. The relay timeout function is an alarm feature that disables the relay after a specified time.

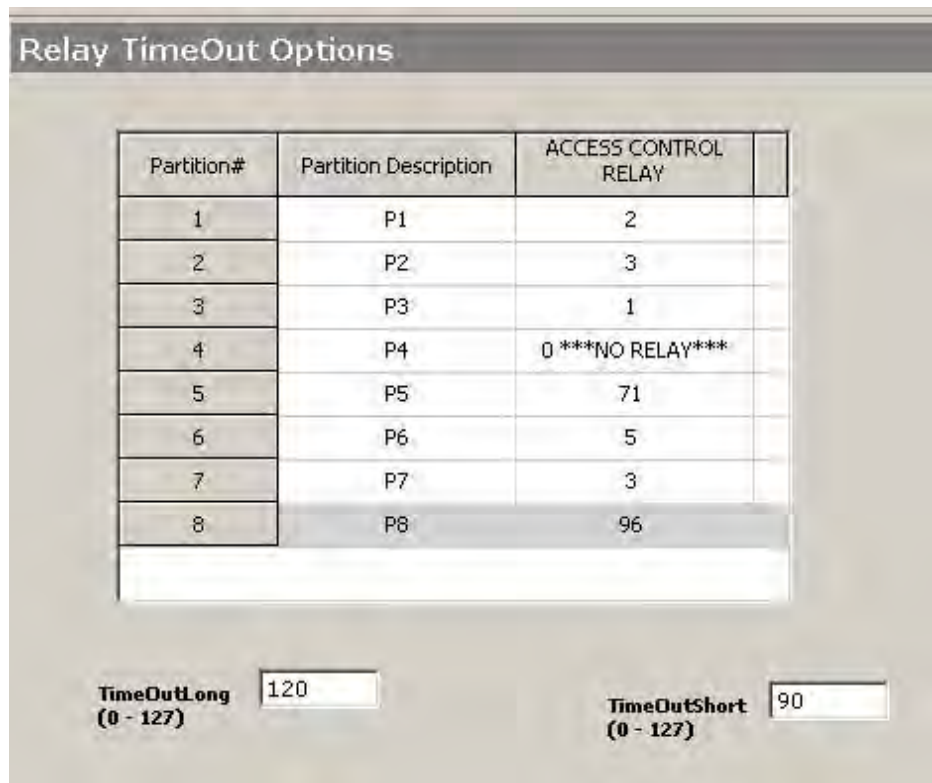

Relay Zone List	Assign a zone to a zone list. Select the zone, and the list that you would like to assign it to, and click <b>Associate</b> . The association is displayed in the grid. To dissociate, click <b>DisAssociate</b> .
-----------------	--



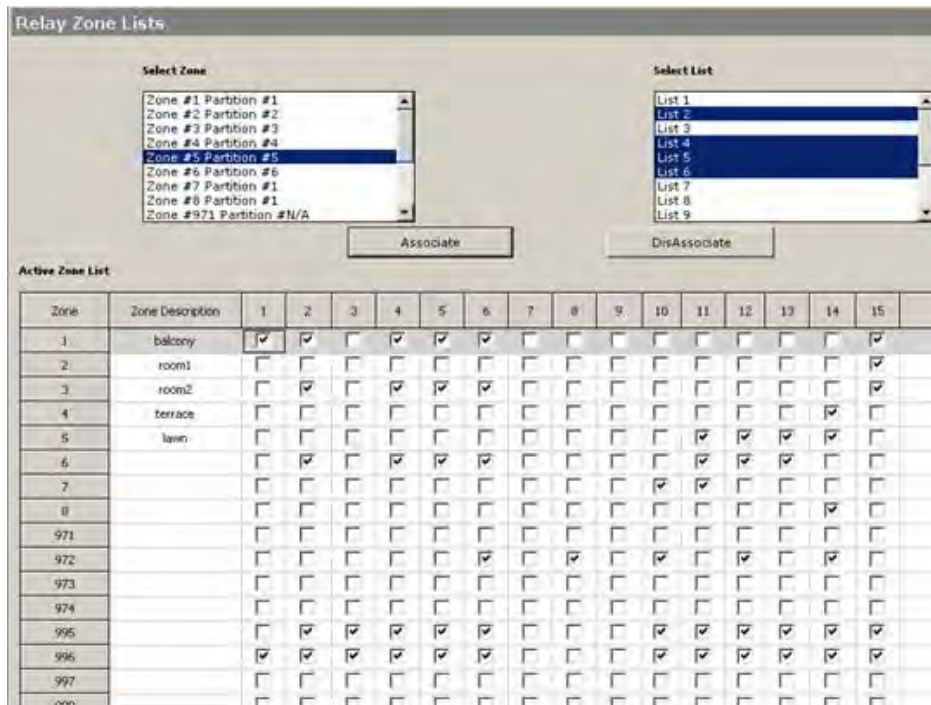

Output devices

Configure output relay devices.



Voice Description

Configure the descriptions for panels supporting voice alarms. The 'Old Word' columns are non-editable, and they take the existing value of the descriptions. Change the 'New Word' columns to the most recent description.

Voice Description						
Relay	Old Word1	Old Word2	Old Word3	New Word1	New Word2	New Word3
1	CENTRAL	AREA	CLOSED	CENTRAL	AREA	CLOSED
2	Third	APARTMENT	ALARM	Third	APARTMENT	ALARM
3	ALARM	Off	NA	ALARM	On	NA

## Access

The configuration of the access groups, access points, and card data is done in this section of the panel application.

Parameter	Allows you to...
Access Group	<p>Define the access group configuration.</p> <p>An access group provides a means of defining which access points can be used, when, and by whom. Any, all, or no access points may be assigned to an access group. Schedules, when assigned to an access group, define the times at which the access points will allow access. The access group can be assigned to a particular cardholder, thereby defining who will be granted access through specified access points during specified periods of time.</p> <p>A special 'executive privilege' attribute allows access anywhere, anytime to the cardholder assigned to the access group.</p>

**Access Group Configuration**

Group #	Group Enable Status	Trace	Executive Privilege	Partition armed restriction
1	Enabled	<input checked="" type="checkbox"/>	<input type="checkbox"/>	Partition(s):3
2	Disabled	<input type="checkbox"/>	<input checked="" type="checkbox"/>	Partition(s):1, 2, 3
3	Enabled	<input checked="" type="checkbox"/>	<input type="checkbox"/>	Partition(s):2
4	Disabled	<input type="checkbox"/>	<input checked="" type="checkbox"/>	Partition(s):6, 7
5	Enabled	<input checked="" type="checkbox"/>	<input type="checkbox"/>	Partition(s):7, 8
6	Disabled	<input type="checkbox"/>	<input type="checkbox"/>	Partition(s):
7	Enabled	<input checked="" type="checkbox"/>	<input type="checkbox"/>	Partition(s):

**Enby Event/Action:**

Point #: 1  
 Event Type: 2 - Access request  
 Action On: Arm/Disarm  
 Action Type: 22 - Disarm

**Egress Event/Action:**

Point #: 2  
 Event Type: 4 - Any request  
 Action On: Bypass  
 Action Type: 31 Auto unby pass-Zone List  
 Zone List #: 7

**Partition Specifier:**

- Partition 1
- Partition 2
- Partition 3
- Partition 4
- Partition 5
- Partition 6
- Partition 7
- Partition 8

Enable to NOT allow access (except for exec. priv.) for Partition 1

Access Point

Configure access points.

An access point is a particular point of passage over which we have control. There are a number of components that can be associated with the access point, which helps to reinforce the desired level of security.

Point#	Status	Re-latch logic	DSM/DSMB Configuration	GP Zone	Reader Position	Reader Configuration	ReqToExit Enable	ReqToExit Door Strike	ReqToExit Retrigger
1	1 Bypassed	On Door Close	Normally Closed	Normally Closed	Entry	Weigand Card	<input checked="" type="checkbox"/>	<input checked="" type="checkbox"/>	<input checked="" type="checkbox"/>
2	2 Locked	On Door Open	EOLR N.O.	EOLR N.O.	Entry	Weigand Card	<input checked="" type="checkbox"/>	<input checked="" type="checkbox"/>	<input checked="" type="checkbox"/>
3	3 Exit Only	On Door Open	EOLR N.C.	EOLR N.C.	Exit	Weigand Card	<input checked="" type="checkbox"/>	<input checked="" type="checkbox"/>	<input checked="" type="checkbox"/>
4	Unused	On Door Close	Normally Open	Normally Open	Entry	Weigand Card	<input checked="" type="checkbox"/>	<input checked="" type="checkbox"/>	<input type="checkbox"/>
5	Unused	On Door Close	Normally Open	Normally Open	Entry	Weigand Card	<input checked="" type="checkbox"/>	<input checked="" type="checkbox"/>	<input type="checkbox"/>
6	Unused	On Door Close	Normally Open	Normally Open	Entry	Weigand Card	<input checked="" type="checkbox"/>	<input checked="" type="checkbox"/>	<input type="checkbox"/>
7	Unused	On Door Close	Normally Open	Normally Open	Entry	Weigand Card	<input checked="" type="checkbox"/>	<input checked="" type="checkbox"/>	<input type="checkbox"/>
8	Unused	On Door Close	Normally Open	Normally Open	Entry	Weigand Card	<input checked="" type="checkbox"/>	<input checked="" type="checkbox"/>	<input type="checkbox"/>
9	Unused	On Door Close	Normally Open	Normally Open	Entry	Weigand Card	<input checked="" type="checkbox"/>	<input checked="" type="checkbox"/>	<input type="checkbox"/>
10	Unused	On Door Close	Normally Open	Normally Open	Entry	Weigand Card	<input checked="" type="checkbox"/>	<input checked="" type="checkbox"/>	<input type="checkbox"/>
11	Unused	On Door Close	Normally Open	Normally Open	Entry	Weigand Card	<input checked="" type="checkbox"/>	<input checked="" type="checkbox"/>	<input type="checkbox"/>
12	Unused	On Door Close	Normally Open	Normally Open	Entry	Weigand Card	<input checked="" type="checkbox"/>	<input checked="" type="checkbox"/>	<input type="checkbox"/>

Event Action

Configure actions corresponding to certain events.

## Card Data

Configure the access card.

The details of privileges, access group to which the card belongs, event types and actions, number of usages, and the expiration date recorded in this screen.

Click Add Card and enter Enrollment number to begin access configuration.

**Card Data**

**Access Card Data Configuration**

Card #	Status	Enrollment #	Vista User #	User Name
1	Active	123131024568	001	drtest

**General Data**  Executive Privileges  Trace

**Invoke Action** 4 any request **Action Type** Arm/Disarm **Number Of Usage** 2 usage

**Access Point #** 1 **Action Desired** 22 - Disarm **Month** End of Day

**Access Group**

<input checked="" type="checkbox"/>	Group 1
<input checked="" type="checkbox"/>	Group 2
<input checked="" type="checkbox"/>	Group 3
<input type="checkbox"/>	Group 4
<input type="checkbox"/>	Group 5
<input type="checkbox"/>	Group 6
<input type="checkbox"/>	Group 7
<input type="checkbox"/>	Group 8

**Partition Specifier**

<input checked="" type="checkbox"/>	Partition 1
<input type="checkbox"/>	Partition 2
<input type="checkbox"/>	Partition 3
<input checked="" type="checkbox"/>	Partition 4
<input type="checkbox"/>	Partition 5
<input type="checkbox"/>	Partition 6

**Day**

November, 2005

Sun	Mon	Tue	Wed	Thu	Fri	Sat
30	31	1	2	3	4	5
6	7	8	9	10	11	12
13	14	15	16	17	18	19
20	21	22	23	24	25	26
27	28	29	30	1	2	3
4	5	6	7	8	9	10

## Change and Compare

The Change and Compare screen has options to view changes made to Saved, Default, Uploaded and CurrentEdit data and at the same time compare data between any two E2 images.

## Change

Change allows you to see the changes you have made to a view after the last 'Save' operation. To see the changes made to any view select the **View** from the Menu bar. You may select Current Edit, Saved, Default, or Uploaded View. The grid displays the changes that were made to the particular view after the last 'Save' operation. You can select to overwrite the new value with the old value of the features by selecting the appropriate checkbox, or for all features at once by selecting **Select All**. Then click **Merge Selected** to overwrite the values.

The number of changes to the view is displayed at the bottom of the screen.

Note that the **Compare** and **With** fields are disabled when the Change option is selected.

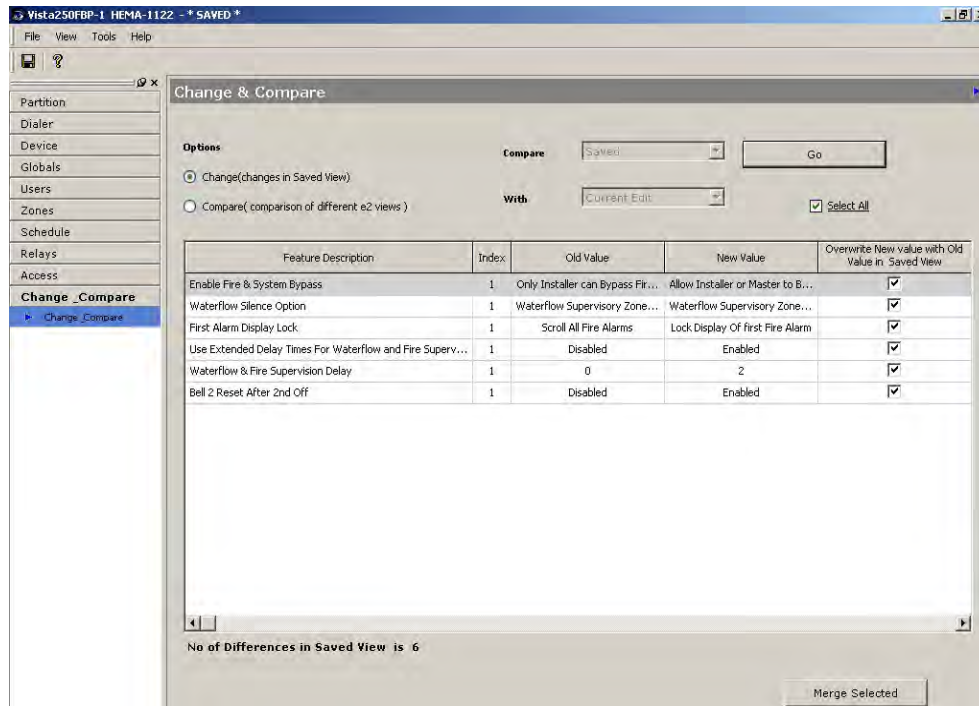

Figure 6-15 Change

## Compare

Use the Compare option to compare your Saved, Default, Uploaded or Current Edit values for each feature with any of the values in the other three E2 views. For example, the Saved value of a feature can be compared with the Default, Uploaded or Current Edit value for the feature.

To compare, select the values to be compared from the drop-downs for **Compare** and **With**. Click **Go**. The features and the comparison of values are displayed in the grid.

The number of differences between the compared values is displayed at the bottom of the screen.

You can overwrite the values for each feature by selecting the **Overwrite...** option in the last column of the grid. To replace all the values with the modified value, select **Select All** above the grid. Click **Merge Selected** to replace the values.

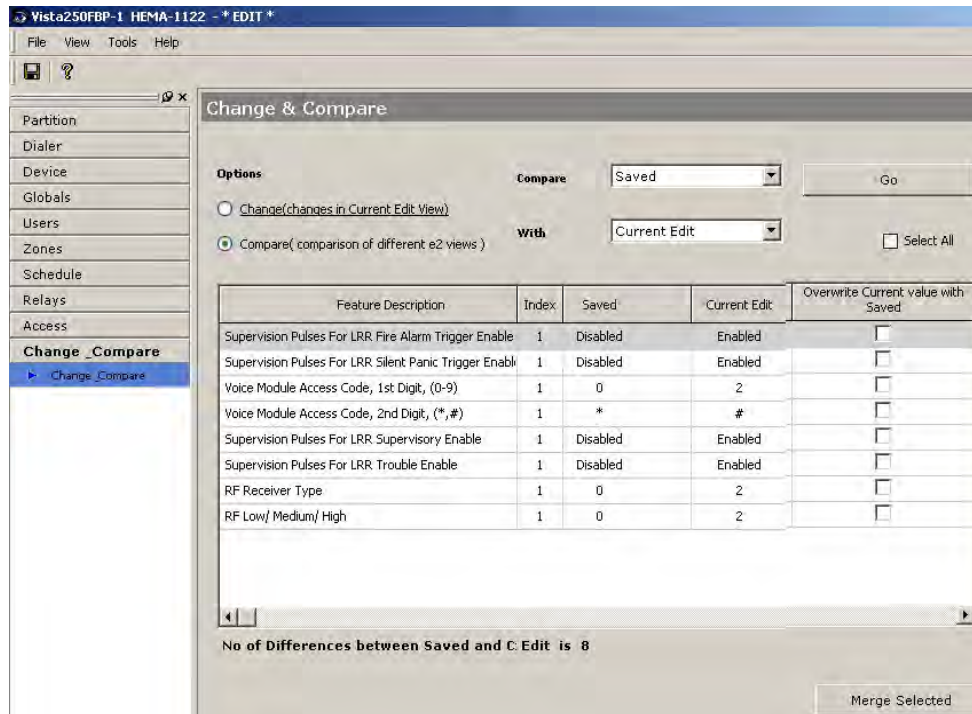

Figure 6-16 Compare

## History

The **ShowLog** screen shows the history of the changed data. The previous and changed values of the feature are displayed. You can specify the date range between which you want the history data. The data in the grid can also be sorted based on the date/ feature description / Operator name. Click **Refresh Data** to refresh the screen.

Show Log							
Start		1/6/2006 11:47:54 AM	End	Present	Sort By	Date	Refresh Data
Operator Name	Feature Description	Index	Date Time	Old Value	New Value		
Master	Master Partition	3	1/6/2006 11:49:18 AM	Disabled	Enabled		
Master	User Code	3	1/6/2006 11:49:18 AM		1237		
Master	ACCOUNT DATA SAVED!	0	1/6/2006 11:47:54 AM	----	Current Edit		
Master	Partition Entry Delay 1	1	1/6/2006 11:47:54 AM	30 sec	60 sec		
Master	Partition Exit Delay 2	1	1/6/2006 11:47:54 AM	120 sec	150 sec		
Master	Partition Entry Delay 2	1	1/6/2006 11:47:54 AM	90 sec	135 sec		
Master	Partition Exit Delay 1	1	1/6/2006 11:47:54 AM	60 sec	75 sec		
Master	Random Timers	1	1/6/2006 11:47:54 AM	Enabled	Disabled		
Master	Permanent Backlight Enable	1	1/6/2006 11:47:54 AM	Enabled	Disabled		
Master	Zone Input Type	5	1/6/2006 11:47:54 AM	1	3		
Master	Zones - Bell & Aux Relay Activation	5	1/6/2006 11:47:54 AM	5 - Bell 1 and Au	6 - Bell 2 and Aux		
Master	Zone Response Type	5	1/6/2006 11:47:54 AM	3 - Perimeter	5 - Trouble Day/Alarm Night		
Master	Relay List Assignment For ECP Zones -Zone 804	11	1/6/2006 11:47:54 AM	Enabled	Disabled		
Master	Relay List Assignment For ECP Zones -Zone 804	10	1/6/2006 11:47:54 AM	Enabled	Disabled		
Master	Relay List Assignment For ECP Zones -Zone 804	2	1/6/2006 11:47:54 AM	Enabled	Disabled		
Master	Relay List Assignment For Relay Zones -Zone 602	15	1/6/2006 11:47:54 AM	Enabled	Disabled		
Master	Relay List Assignment For Relay Zones -Zone 602	12	1/6/2006 11:47:54 AM	Enabled	Disabled		
Master	Relay List Assignment For Relay Zones -Zone 602	11	1/6/2006 11:47:54 AM	Enabled	Disabled		
Master	Relay List Assignment For Relay Zones -Zone 601	12	1/6/2006 11:47:54 AM	Enabled	Disabled		
Master	Relay List Assignment For Relay Zones -Zone 601	11	1/6/2006 11:47:54 AM	Enabled	Disabled		
Master	Relay List Assignment For Normal Zones -Zone ...	3	1/6/2006 11:47:54 AM	Enabled	Disabled		
Master	Relay List Assignment For Normal Zones -Zone ...	2	1/6/2006 11:47:54 AM	Enabled	Disabled		
Master	Partition Primary Sub Id	1	1/6/2006 11:47:54 AM	1122	1122		

Figure 6-17 History

## 5.4 Using Templates

Templates are used to create “master” files for control panel programming data to speed up programming of a new account. A template gives you a very quick and easy way to add a customer’s alarm control programming information.



To access the available Template screen, click  at the top of the Compass Shell screen. The following screen is displayed:

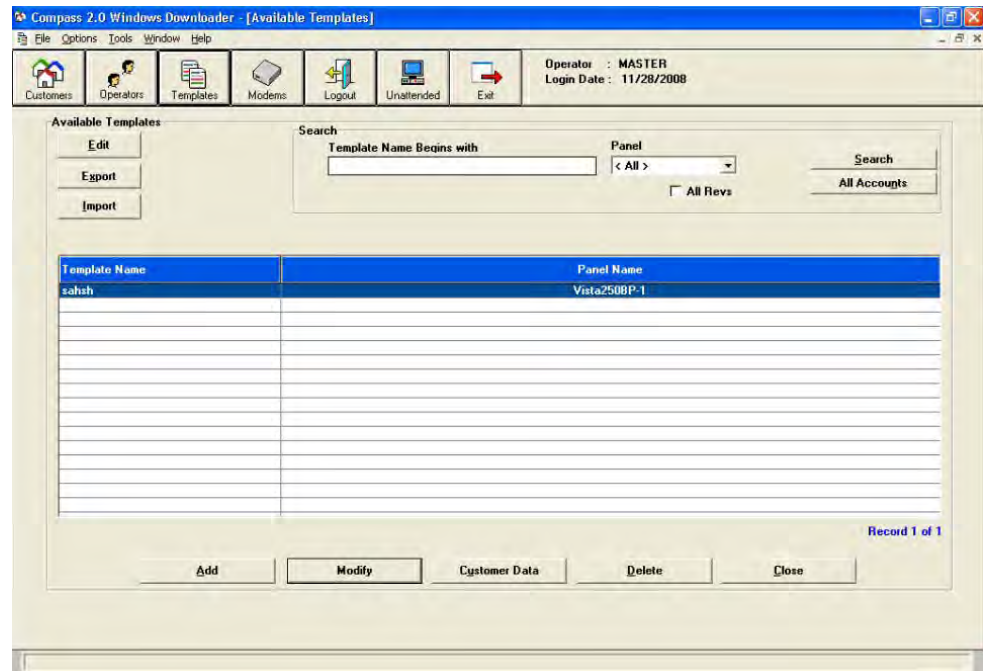
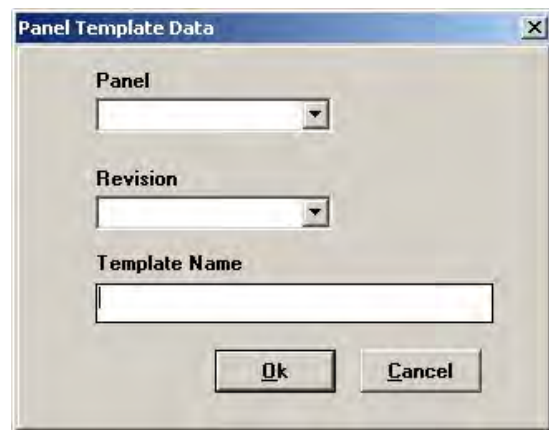

Figure 6-18 Available Templates

## Creating New Templates

To create a new template, click **Templates** at the top of the Customer Information screen, perform the following steps:

Step	Action
1	Click <b>Add</b> in the available templates window (refer to <a href="#">Figure 6-18 Available Templates</a> ). The screen displayed allows you to type the control panel type, the revision, and a name for this template.



- 2 Click **Ok** to save, or **Cancel** to close without saving.



- 3 To edit the data you have saved, click **Edit** to the top-left of the Template Name column (refer to [Figure 6-18 Available Templates](#)).  
The **Panel Template Data** dialog box opens again and allows you to make changes to the Revision and Template Name.



**ATTENTION:** The Panel selection cannot be changed using **Edit**.

## Modifying Templates

To modify an existing template, perform the following steps:

Step	Action
1	Click the <b>Templates</b> icon at the top of the Customer Information screen.
2	Select the template from the Templates list.
3	Click <b>Modify</b> . The alarm control Panel Edit screen opens, where you can program the template information.
4	When you have completed setting up the template, select <b>Close</b> and then <b>Save</b> to save the information.

## Deleting Templates

Use the **Delete** button on the available templates window (refer to [Figure 6-18 Available Templates](#)) to delete an existing template. Confirm deletion when prompted.

## Setting Up an Existing Customer Template

To use another customer's account data as a template, perform the following steps:

Step	Action
1	Create a new template as detailed in the section <a href="#">Creating New Templates</a> .
2	Click <b>Customer Data</b> . The <b>Select Customer Data..</b> dialog box is displayed.

- 3 Type the **Receiver Number** and the **Account Number** of the customer account to be copied.

- 4 Click **Ok** to copy the customer details to the template. Confirm the operation when prompted.

## Using a Template to Create a New Account

Templates speed up the process of programming a control panel.

To use a template to program a control panel, perform the following steps:

Step	Action
1	Create a new account or highlight on the Customer Information screen the account that the template is to be applied to.
2	Click  , at the bottom of the Customer screen. The following screen is displayed:

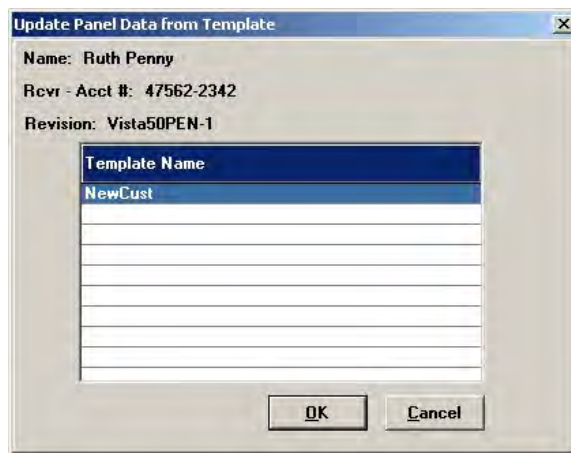

- 3 Select the template to be applied to the account.
- 4 Click OK. The GUISubscriber Tools dialog box is displayed.



- 5 Click **Yes** to update the Panel data from the selected template.

## 5.5 Copying an Account

The Copy command can be used in place of Templates to copy programming information quickly from one control to another.

To copy an account, perform the following steps:

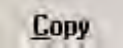
Step	Action
1	Click  at the bottom of the Customer screen. The following dialog box is displayed.

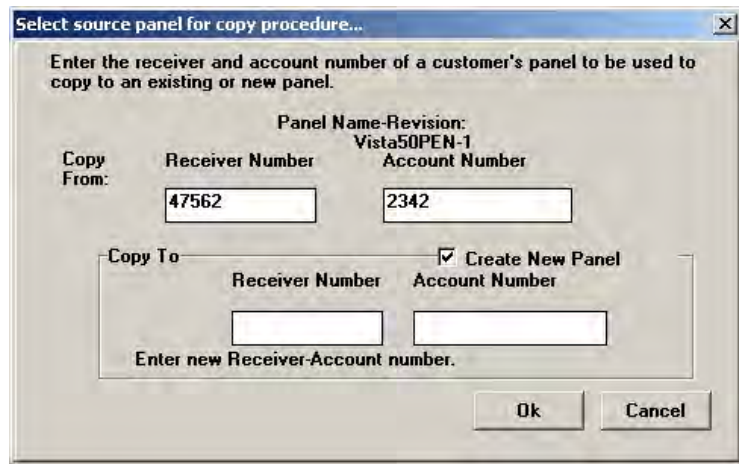

- 2 Type the **Receiver** and **Account** number of the control panel from which the programming information is to be copied.
- 3 Type the receiver and account number of the panel to be copied.
- 4 Selecting **Create New Panel** creates a new panel with the panel type corresponding to the destination account and copies all the data to the new account.



**ATTENTION**

An account can be copied only to another account that uses the same control panel type and revision.

---

## 6. Interactive Communications

### 6.1 On-Line Communications

The redesigned Compass 2.0 Communication Server (Commserver) supports a set of panels with the Ademco, FBII, and Apex protocols. You can continue to use the Compass 16 communication server for the unsupported panels.

The following chapter guides you through Interactive Communications for Ademco, FBII, and Apex control panels.

### 6.2 Ademco

#### Launching the Ademco Commserver

To launch Interactive Communications with an Ademco panel, perform the following steps:

Step	Action
1	From the Customer Account Screen, customer table, select an Ademco customer.
2	Click <b>Modify</b> in the Panel Options toolbar. The Panel Programming screen is displayed.

Panel for Compass 16

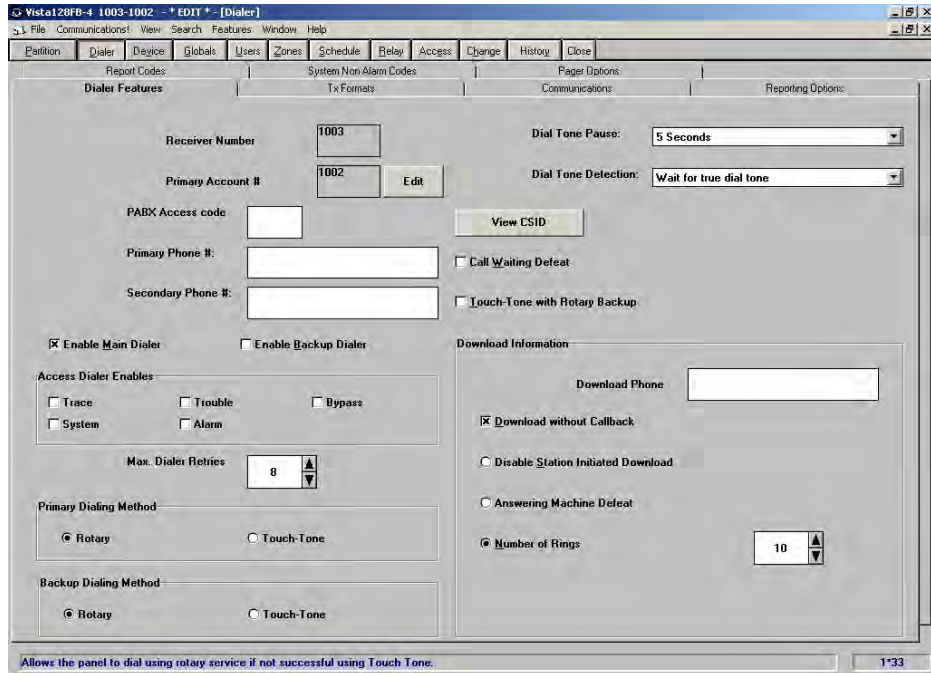

Panel for Compass 2.0

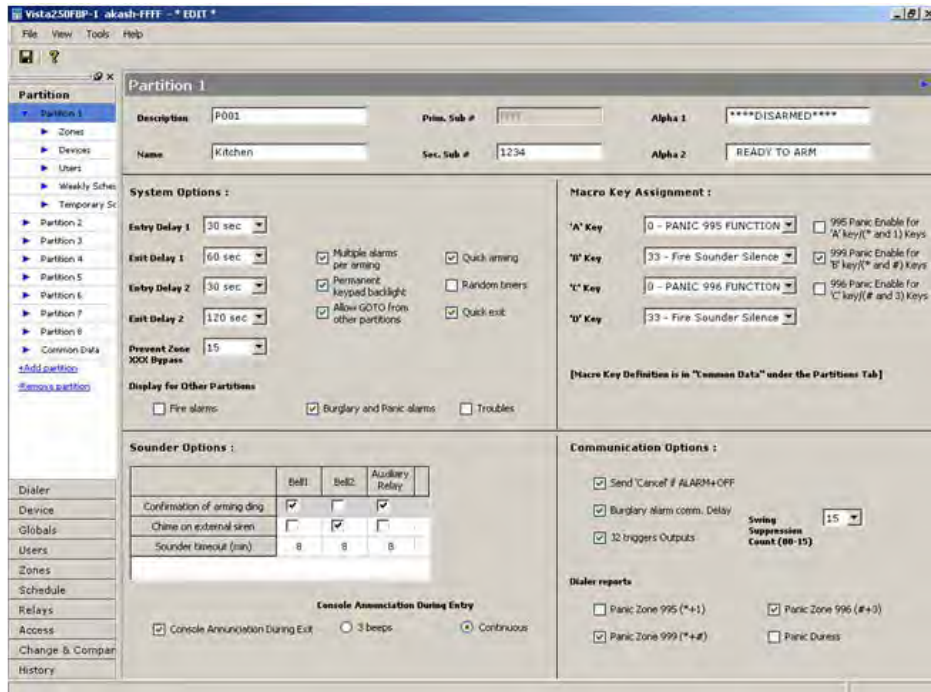

- 3 Select **Communications** from the “Tools” option in the menu bar of the Panel Programming screen. You can alternatively click the Communication Toolbar button as high-lighted below -



The Compass Communications screen for the selected account is displayed.

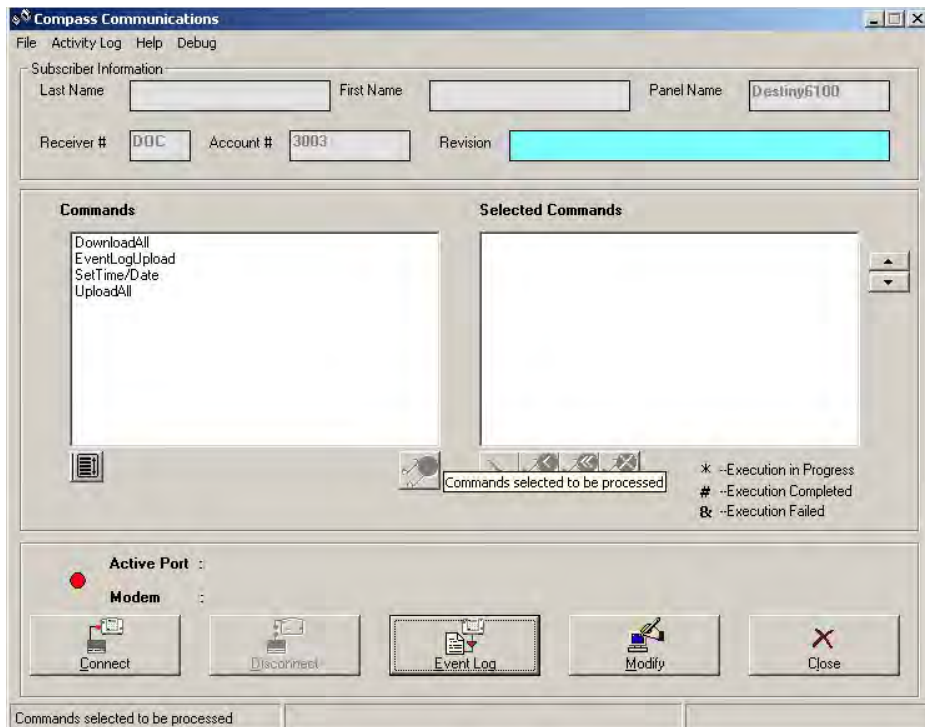

**Figure 7-1 Compass Communication - Ademco Interactive UI**

- 4 Click **File> Communication Settings**.  
The Communication Settings screen is displayed.

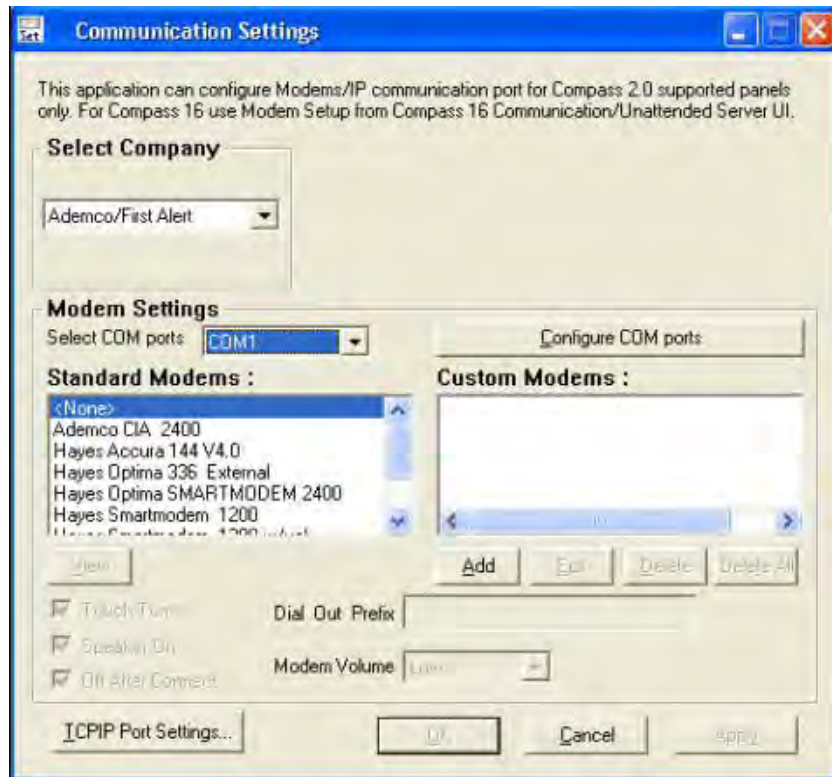

- 5 Ademco is selected as the default company as you have selected a customer who uses an Ademco panel.  
After the modem is configured, click **Apply**. Click **OK** to close the Modem dialog box.



**REFERENCE– INTERNAL:** For more information on modem setup see [2.2 Setting up the Modem](#).

- 6 Click **Connect** on the Communications screen.  
The Communications dialog box is displayed:

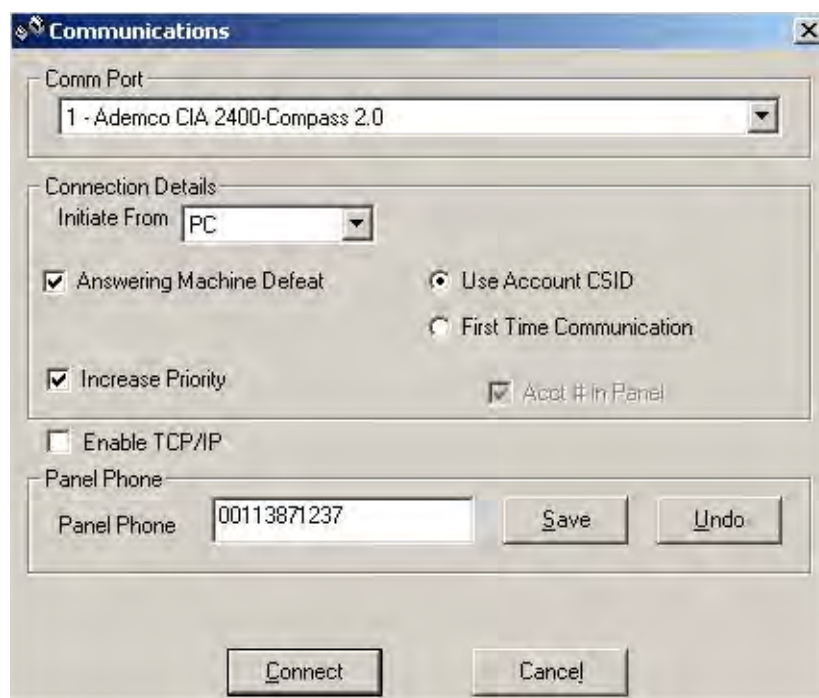

**Figure 7-2 Communications - Connection Details**

Configure the connection details here.

- 7 Select the **Comm Port** from the drop-down.
- 8 In the **Initiate From** box, select the origin of the call. It might be **PC** or **Panel**. If your control is directly connected to your computer's serial port, (if supported by the control) select **Direct**. In **Direct**, the PC and Panel are connected by a RS232 cable. On some panels, a **Telco** option is also available. The setup in Telco is very similar to Direct except that there are telephone handsets placed at both ends that enable voice communication.



**ATTENTION:** The **Direct** and **Telco** modes are only for **Interactive Communications**. They are not applicable to **Unattended Communications**.

- 9 Select **Answering Machine Defeat** if there is an answering machine at the premises. The ring count in the panel should be programmed for 15.



**REFERENCE– INTERNAL:** For more information, refer to [Configuring for Answering Machine Defeat](#).



- 10 Type the **panel phone number** if it is not already entered in the Customer Detail screen.  
To save the phone number, select **Save** to the right of the control panel phone number. This is the number used for calling this particular panel, and is displayed on both the Customer Detail and Communications screens.



**TIP:** If you need to change the number, type the new number and select **Save** again. The old number is overwritten. If you want to temporarily use another number, type it, and after the session, select **Undo**. You are asked if you want to restore the earlier number. Select **OK**.

- 11 To use the TCP/IP connection, select **Enable TCP/IP**.  
The following window is displayed:

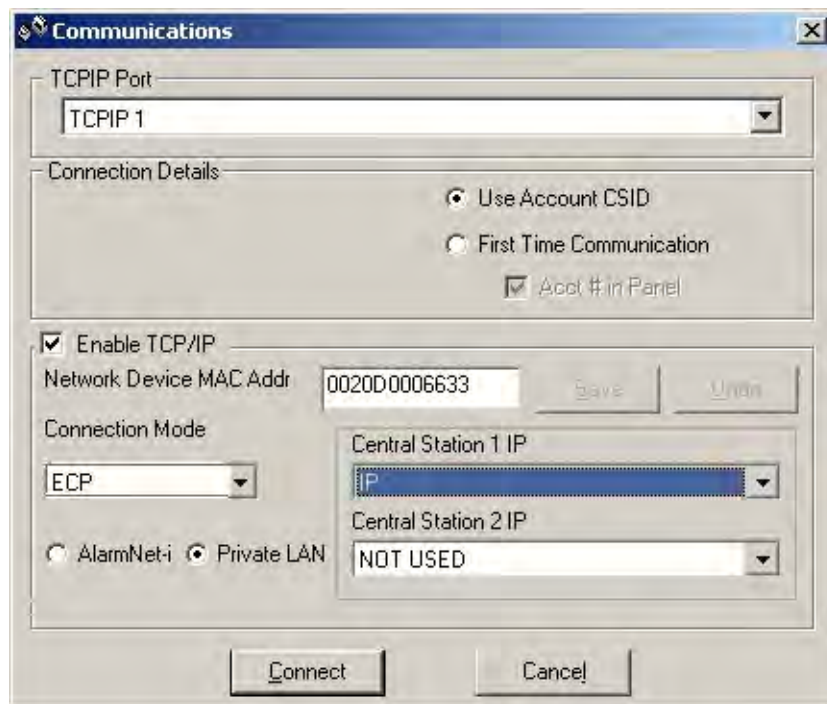

- 12 Select TCP/IP port from the drop-down.  
Select the required option for **Connection Mode** - Direct Wire or ECP, based on whether you want to connect to the Panel through Direct Wire or through ECP.  
If you want to communicate over an Intranet, select the option **Private LAN** and select **Central Station 1 IP** and/or **Central Station 2 IP** from a list of the 7810iR Device names that you have configured through File -> Device and Computer Names/ IP Addresses.



**REFERENCE- INTERNAL:** For more information, refer to [2.4 Mapping Devices to IP](#).

- 13 If you want to communicate with the panel over Internet (through AlarmNet-i Control Server), select the option **AlarmNet-i**.



**REFERENCE– INTERNAL:** For information on configuring the Alarmnet-i URL, refer to **2.2 Setting up the Modem**.

- 14 Type the **Network Device MAC Addr** (IP communication Device MAC address) if it is not already entered in the Customer Detail screen.  
To save the MAC address, select **Save**. This is the address used for connecting to this particular panel through TCP/IP, and is displayed on both the Customer Detail and Communications screens.



**TIP:** If you need to change the address, type the new address and select **Save** again. The old address is overwritten. If you want to temporarily use another address, type it, and after the session, select **Undo**. You are asked if you want to restore the earlier address. Select **OK**.

- 15 Some panels, like the Lynx family panels, support a Flexible Callback Option. The Download phone number that you type in the dialer screen of the panel (see figure below) is used as the basis for the callback number.

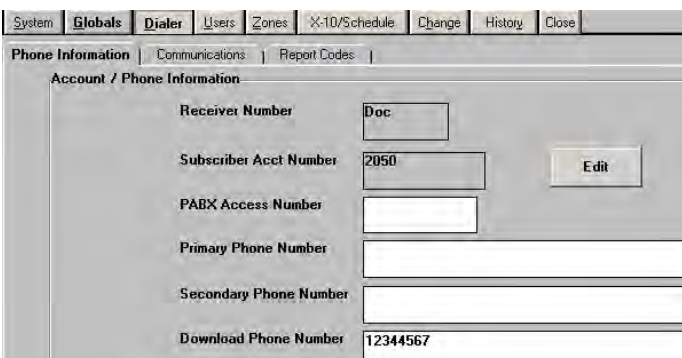

The figure below shows the Flexible Callback Phone Number option. This option allows you to change the last three digits of the configured callback number.

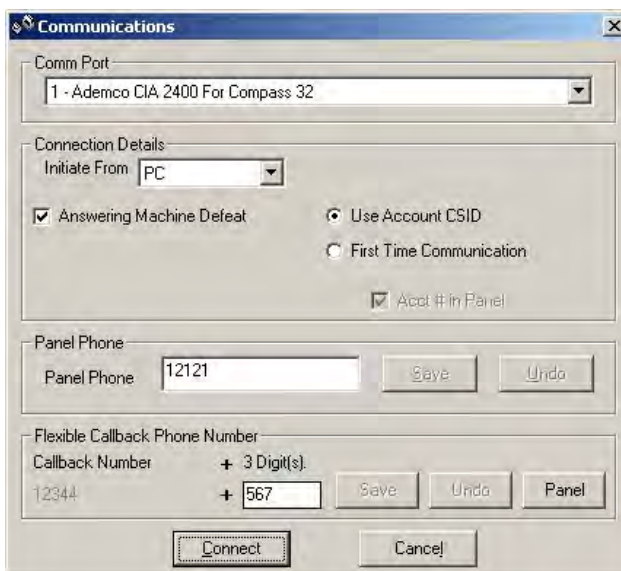

- 16 Select **Use Account CSID** if the panel you want to communicate with has already been downloaded. Otherwise, select **First Time Communication** and select **Acct # in Panel** if the account number is available in the panel.  
If the panel is yet unprogrammed, select **First Time Communication** without selecting Acct # in the panel.
- 17 Click **Connect**.
- 18 The PC calls the panel if **Initiate From PC** was selected.  
If Callback is enabled, the modem disconnects and waits for the panel to call back.  
If Initiate from Panel was selected, the Installer Code + [#] + [1] must be entered at the panel keypad, which causes the panel to call the PC. The progress of the connection is displayed at the bottom of the screen.  
  
After the initial exchange and verification of the CSID and the subscriber account number, a **Status** screen is displayed. This screen displays the current status of the panel:



**ATTENTION**

If you select **First Time Communication**: The panel must be programmed for a **Ring Detect** greater than zero, and a **Download Callback Number**. If Callback is disabled at the panel, you must also enable **Download Without Callback** in the Downloader.

If you select **USE ACCOUNT CSID**:

- The panel must have a **Ring Detect Count** greater than zero.
- If the panel has Callback enabled, a Download Callback Number must also be programmed.
- If Callback is disabled at the panel, you must enable **Download Without Callback** in the Downloader.
- The subscriber's account number must be programmed into the panel and must match what is in the Downloader.

If any of these items do not match, the panel does not get on-line with the Downloader.

## Available Options in Ademco

There are various settings you can configure from the **Options** menu in the Communications Menu bar.



### ATTENTION

In Unattended Communications, the options are accessible from the Settings button of the Setup window. For more information, refer to step 3 of [Setting up Ademco Unattended Mode](#).

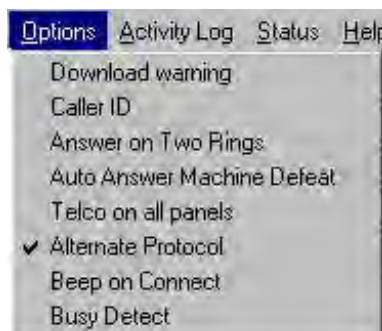

**Figure 7-3 Ademco Communication Options**

Option	Description
Download Warning	Issues warning, if you attempt to download without first performing an upload during the current communication session. You can still perform the download without performing the upload.
Caller ID	Displays the Caller's information on the Customer Detail screen during the connection.
Answer on Two Rings	Answers an incoming call on the second ring. This is particularly useful while using the Caller ID feature. The Caller ID signal is sent between the first and second rings.
Auto Answer Machine Defeat	If this option is selected, the answering machine is automatically defeated irrespective of whether manual defeat is selected or not.
Telco on all Panels	All connections are made through the Telco mode irrespective of selection in the communication window.
Alternate Protocol	Helps to maintain the connection when disconnect problems occur during upload/download.
Beep on Connect	Causes the computer to beep when a connection to the panel is established.
Busy Detect	Enables the X4 option of the modem, which reports if the phone is busy.

## Log reports available in Ademco

Event Logs, or the list of all events with the time and date are recorded in Ademco, as in all the other protocols. However, in some high-end panels of Ademco, in addition to Event Logs, other options like ECP (Expander Console Protocol) reports, Fire Test reports, and Unsolicited alarm reports. They are explained as follows:

- **ECP Reports:** Lists all the addressable devices connected to the system (keypads, voice module, and other devices).
- **Fire Test Reports:** Views the results of the Fire Walk Tests that have been logged onto the panel.
- **Unsolicited Alarms:** Lists all alarms that have occurred when on-line.



### REFERENCE- INTERNAL

For more information on Event logs, refer to 6.5 Event Logs and Viewing Event Log (Ademco) ( in section 9.3.).

## Configuring for Answering Machine Defeat

Sometimes the Downloader might have to initiate calls to sites that have an answering machine. In such cases, you must ensure that the call is picked by the panel and not by the answering machine.

To do that, perform the following actions:

1. Enable the modem speaker in the Downloader Communications screen so that you can hear the phone ringing at the site.
2. Enable **Answering Machine Defeat** in the Connect screen of the Downloader or in the **Dialer** section of the panel programming screen.
3. Program the panel's **Ring Detect Count** for 15 rings.

To initiate connection to a site with an answering machine, perform the following steps:

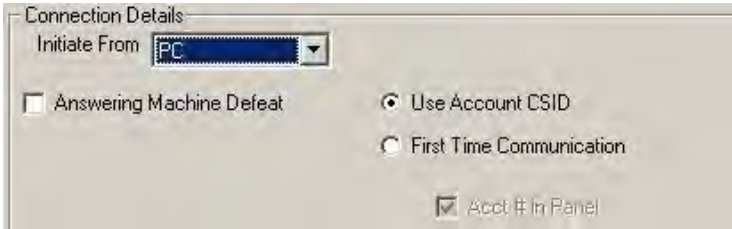
Step	Action
1	Select <b>Answering Machine Defeat</b> on the Downloader Communications screen.
	
	A prompt appears asking you to "Press Escape or Click OK after first Ring". Press the Escape key or click <b>OK</b> .
2	The first call is disconnected immediately and a second call is made. The panel picks up on the first or second ring of the second call, 'defeating' the answering machine. If the panel is programmed for Callback Required, it hangs up and calls the PC.
3	The PC takes the call and a connection is established.

## 6.3 FBI

### Launching the FBI Commserver

To launch Interactive Communications with an FBI panel, perform the following steps:

Step	Action
1	Go to the <b>Customer Account Screen</b> and select the FBI customer from the grid.
2	Click <b>Modify</b> in the Panel Options toolbar. The Panel Programming screen for the selected panel is displayed.

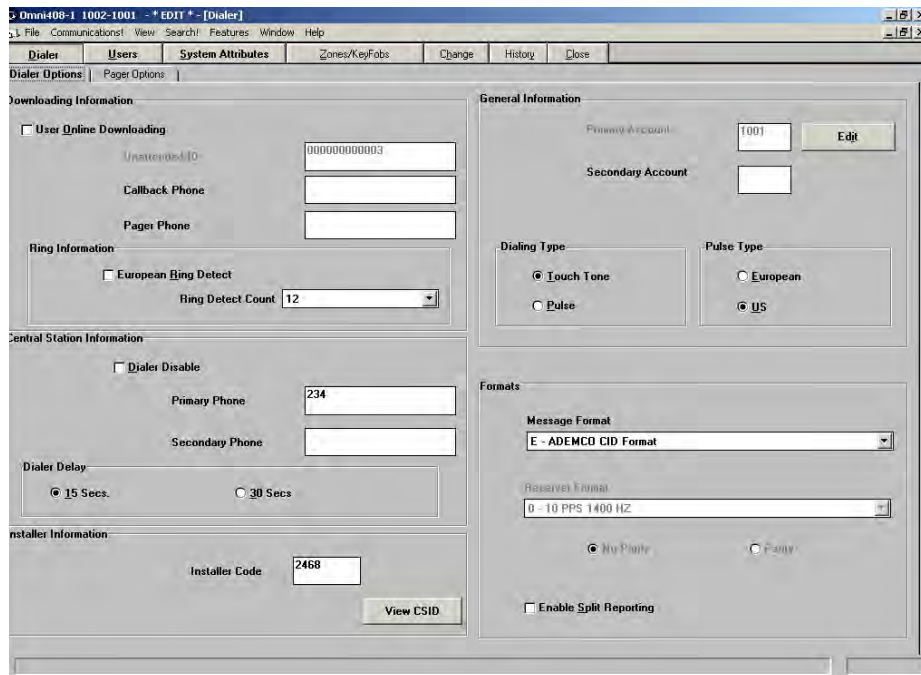

- 3 Select **Communications!** from the menu bar of the Panel Programming screen.  
The **Compass Communication** screen is displayed.

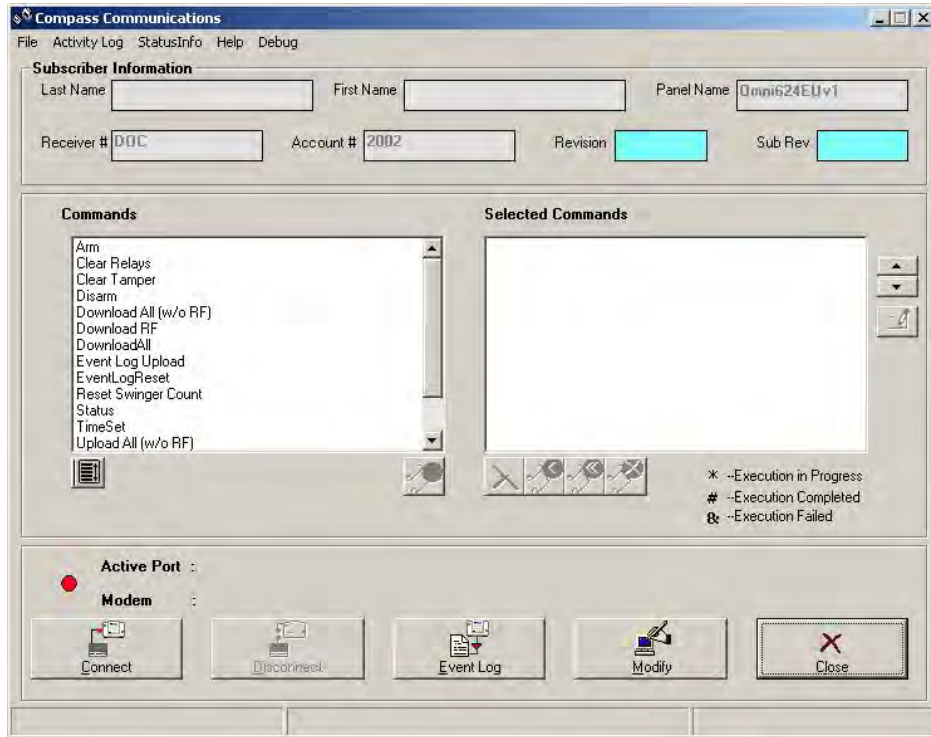

**Figure 7-4 Compass Communication - FBII Interactive UI**

- 4 Click **Connect**. The Communications dialog box is displayed.



- 5 In the **Initiate From** box, select the origin of the call. It could be **PC** or **Telco**.  
 If your control is directly connected to your computer's serial port, select **Telco**. In **Telco**, the PC and Panel are connected by an RS232 cable. Telephone handsets at both ends enable voice communication.  
 Compass initiates communications with the panel. When on-line, you can modify the existing account programming information and perform a number of online commands.



**ATTENTION:** The Telco mode is only for Interactive Communications. It is not applicable to Unattended Communications.

### Setting up the Modem for FBII panels

To configure the modem for FBII panels, perform the following steps:

Step	Action
1	Click File> Communication Setup in the menu bar. The following screen is displayed:

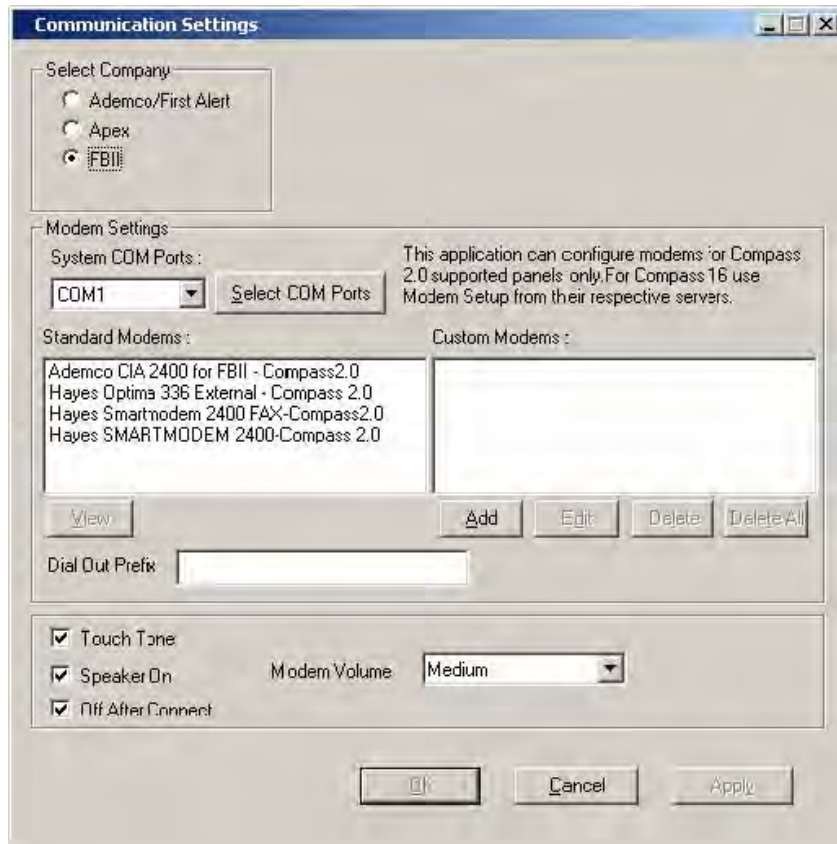

**REFERENCE- INTERNAL:** For more information on modem setup, see [2.2 Setting up the Modem](#).



- 2 FBII is selected as the default company. You can select a modem from the available list or click **Add** under Custom Modems, to configure a new modem that is not in the list.
- 3 Select the **COM Port**.
- 4 Select **Touch Tone** and **Speaker on**, if required. Adjust **Volume**.
- 5 Type the **Dial Out Prefix**.
- 6 Configure the FBII F7702 Interface.  
 [REFERENCE- INTERNAL: For details on configuring the Interface, refer to FBII F7702 Interface.](#)
- 7 Click **OK**.

### Available Options in FBII

Click Options in the menu bar to view the different options available in FBII panels.

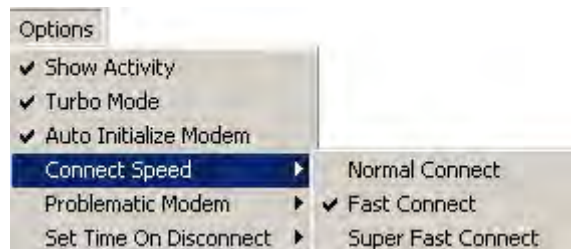

**Figure 7-5 FBII Communication Options**

Option	Description
Show Activity	If this option is enabled, the UI shows the progress of communication activities like send/receive data. This is applicable only to Compass 16, and not to Compass 2.0.
Turbo Mode	If this option is selected, no status request occurs between commands. A status request is sent only if there are no pending commands, or if the command requires a status command to end.
Auto Initialize Modem	This option initializes the modem on connect.
Connect Speed	It is the speed at which the connection is made. You can choose Normal, Fast, or Super Fast.
Problematic Modem	This option is used to help diagnose and bypass modem problems. The DTR (data terminal ready) line is used to get the modem's attention. Sometimes this line is not well connected to the cable running from the PC to the modem.

To check for a bad cable set:

- 1 Choose the Toggle DTR On First Command and Drop DTR 3.1 Seconds options.
- 2 Do a fake Connect Panel Initiated.
- 3 If the Modem Status TR indicator light goes off on the screen but not on the modem, the DTR signal is not getting through to the modem.
- 4 This can probably be corrected by replacing the modem cable. If replacing the cable does not correct the “Unable to put modem in command state” problem, select the Alternate At/Hangup (Bad Modem Cable) option.

Alternate AT/Hangup

This option changes the method used for obtaining get the modem’s attention and disconnects the modem by an alternate method.

Set Time On Disconnect

You can set time on disconnect **Always**, **Never**, or when **Prompted**.

## 6.4 Apex

### Launching the Apex Commserver

To launch Interactive Communications with an Apex panel, perform the following steps:

Step	Action
1	Go to the <b>Customer Account Screen</b> and select an Apex customer from the customer table.
2	Click <b>Modify</b> in the Panel Options toolbar. The Panel Programming screen for the selected panel is displayed.

- 3 Select **Communications!** from the menu bar of the Panel Programming screen.  
The **Compass Communication** screen is displayed.

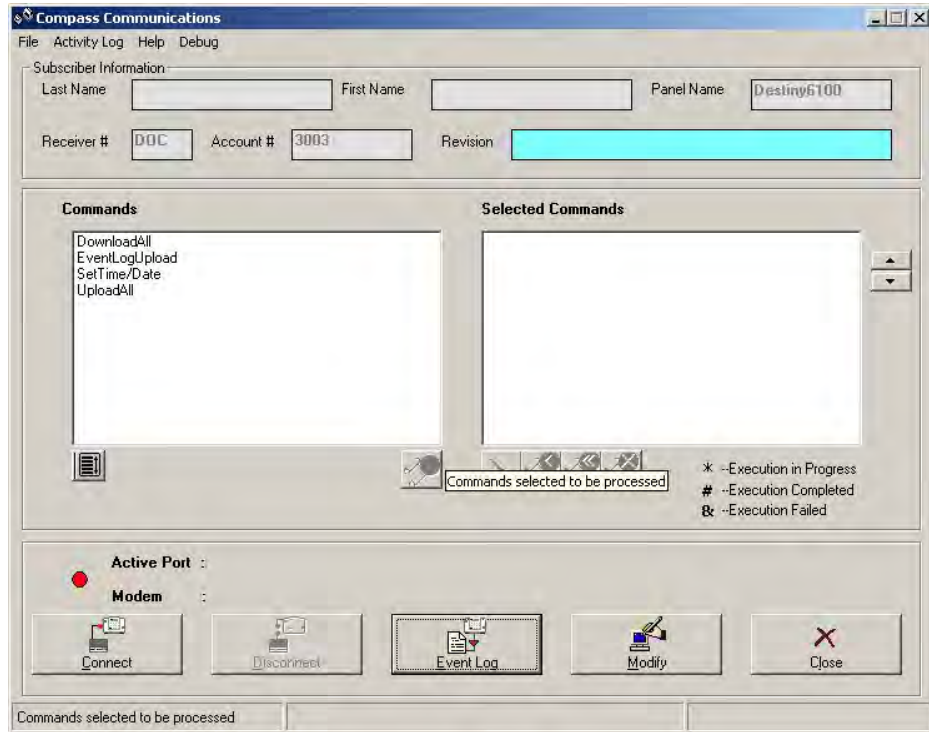
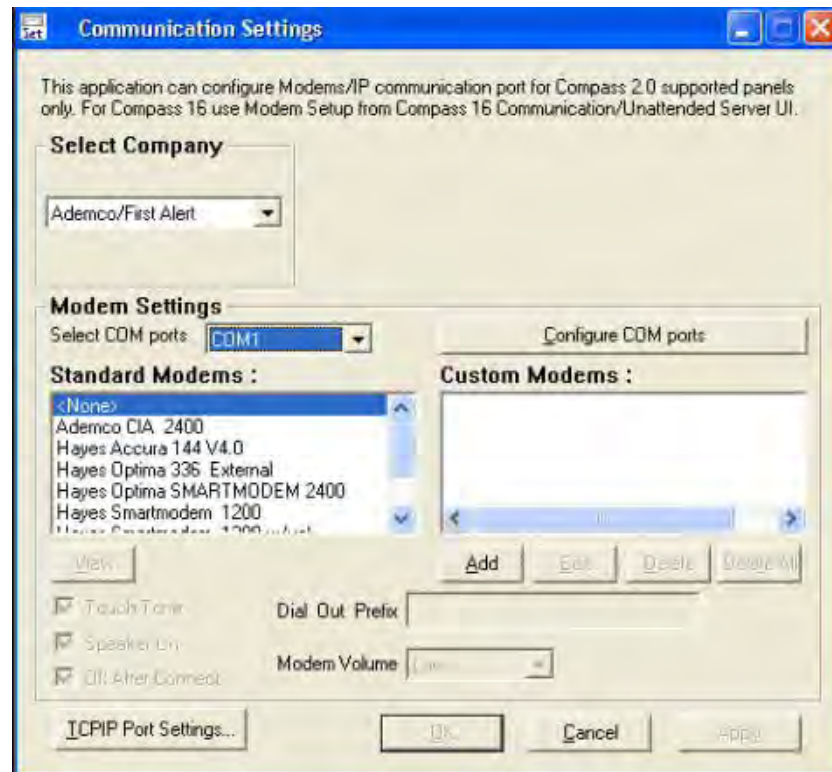

Figure 7-6 Compass Communication - Apex Interactive UI

- 4 Click **File> Communication Setup** in the menu bar.  
The following screen is displayed:



The modem setup is very similar to Ademco. For more information, refer to [2.2 Setting up the Modem](#).

- 6 After the modem is set up, click **Connect** in **Compass Communications**. The following screen is displayed:



- 7 Type the **Panel Phone** number.
- 8 Select the **Connection Type** and **Answering Machine Override Digit**. The PC Access Code is passed internally. Do not type it.
- 9 Click **Connect**.

## 6.5 Event Logs

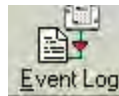

Event Logs can be viewed either by clicking **Event Log** at the bottom panel of **Compass Communications**, or through **File>View Logs>Event Logs** in the menu bar of the same screen. The Event Log is displayed as illustrated below.

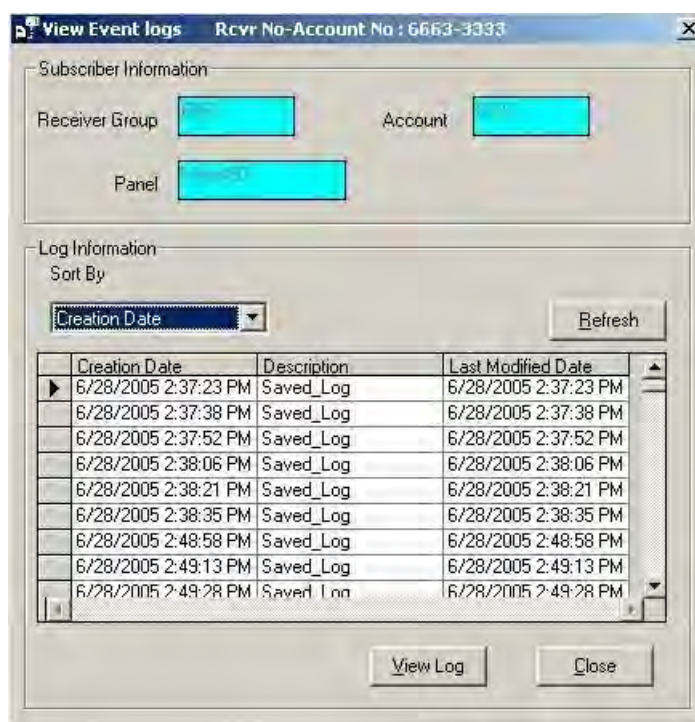

**Figure 7-7 Event Log - Interactive Communication**

To obtain the details of the event, select a row and click **View Log**, or double-click the row. The **Event Log Response** screen is displayed as illustrated below.

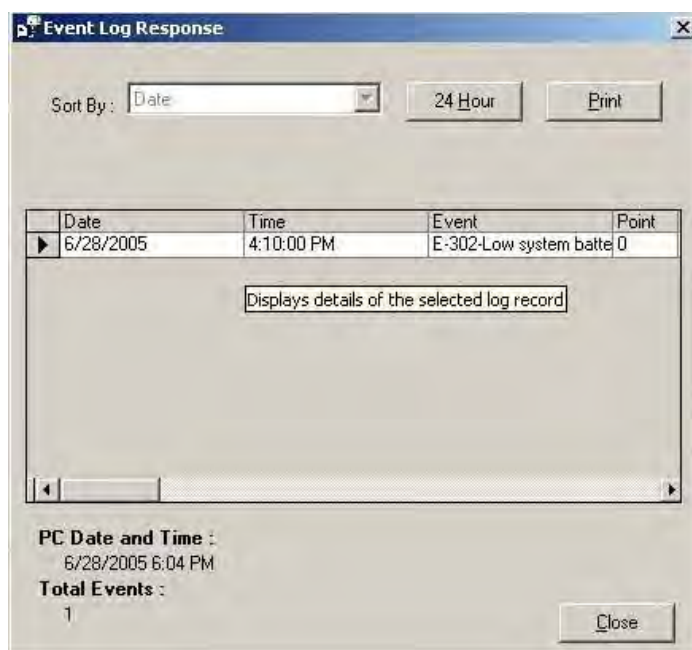

**Figure 7-8 Event Log Response - Interactive Communication**

The details of the selected log recorded are displayed here. You can click **24 hour** to see the time in a 24 hour format. To print the details, click **Print**.

## 7. Unattended Communications

### 7.1 Unattended Operation

Unattended Operation allows communication between the Downloader and the control panel even in the absence of the operator.



#### ATTENTION

'Unattended Mode' in Compass 16 is renamed as 'Scheduled Mode' in Compass 2.0. We have used 'Unattended' and 'Scheduled' interchangeably in this user guide.

There are three types of Unattended modes available in Compass. They are: Unsolicited Mode, Scheduled Mode, and Mixed Mode.

#### Unsolicited Mode

In the Unsolicited mode, the Server is not informed in advance that a panel is calling in. When a Server receives a call from a panel, it must determine what type of panel it is communicating with, and perform the appropriate task.

#### Scheduled Mode

In the scheduled mode, the Server checks for scheduled jobs to be performed on a panel at a certain time. At the scheduled time, the Server connects and performs the tasks scheduled by the operator for the panel.

In this case, the PC initiates the call or calls the panel, disconnects, and waits for a callback.



#### REFERENCE- INTERNAL

For more information on how the scheduled mode of operation works, refer to [Working of the Scheduled Mode](#).

#### Mixed Mode

In the mixed mode, both Unsolicited and Scheduled modes are activated. The Server operates in the Unsolicited and Scheduled modes simultaneously. It executes scheduled jobs at their pre-defined times; and, when not busy, answers unsolicited calls. This is the default mode and recommended mode of Unattended operation.

### 7.2 Assigning Receiver Groups

You can add, edit, or delete a mapping of Receiver Group to Primary Phone number using the Receiver Group Assignment function.

You may assign duplicate account numbers to accounts programmed to report to different central station primary phone numbers. When duplicate account numbers are used during uploading, the Receiver Group Assignment option prevents one account from overwriting another that has the same account number.

When a control panel using the primary telephone number that is associated with a Receiver Group calls for uploading, it is automatically connected to the corresponding Receiver Group.

To assign receiver groups to phone numbers, perform the following steps:

- | Step | Action   |
|------|--|
| 1    | On the Customer screen menu of the Downloader, select <b>File &gt; Receiver Group / CS Phone #</b> . |
| 2    | Click <b>Add</b> in the <b>Receiver Group Options</b> in the bottom toolbar of the screen.           |

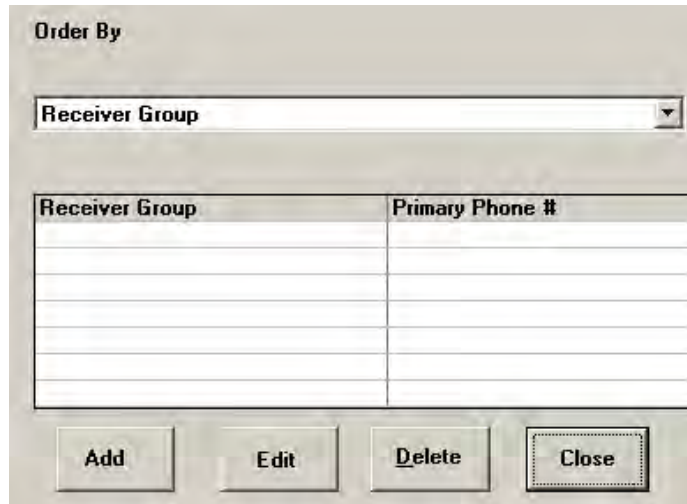

- 3 Type the Receiver Group details (It takes a maximum of six characters or numbers) and the corresponding primary phone number.

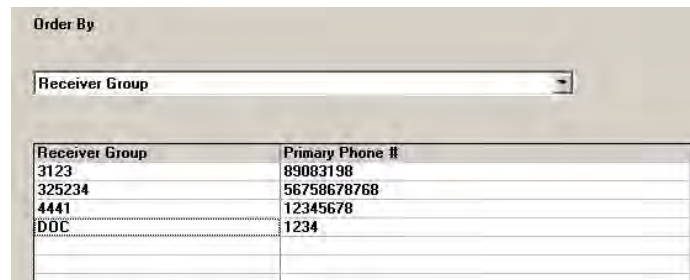

- 4 Click **Ok**. (When the screen is in Add Mode, the Add button is changed to Ok button)
- 5 Enter a different Receiver Group for each central station primary phone number that you use.



**ATTENTION**

If the Downloader does not have a corresponding Receiver Group for a primary phone number, when it receives an unsolicited call from a control panel for uploading, the Receiver Group displayed for that phone number appears as a series of six question marks (??????).



## 7.3 Viewing Scheduled Jobs

To view scheduled jobs, perform the following steps:

- | Step | Action   |
|------|--|
| 1    | Click <b>Unattended Jobs</b> in the top left of the Customer Information screen.<br>The following screen is displayed: |

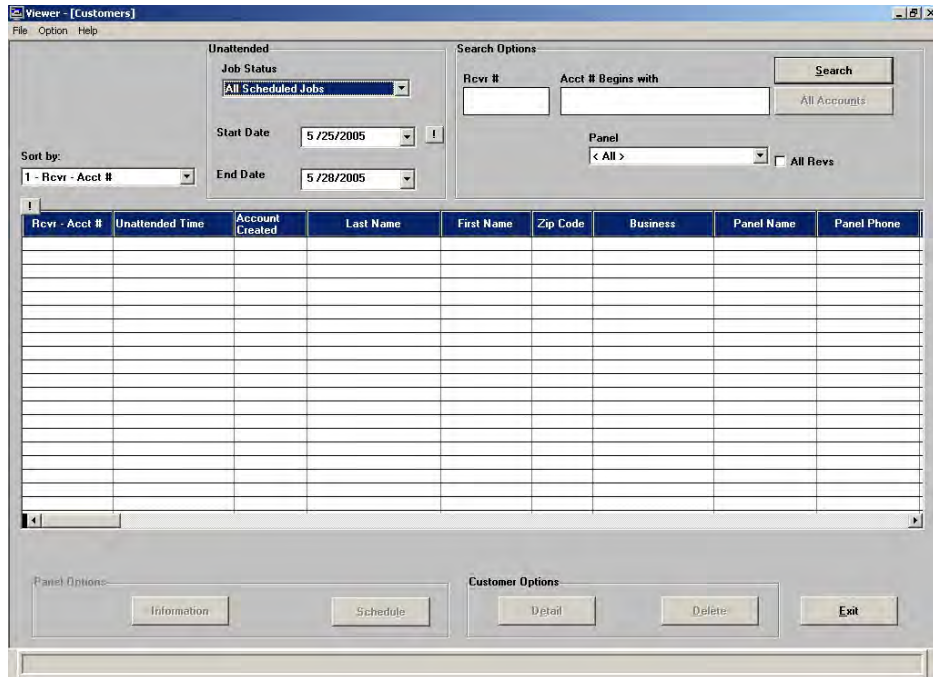

- 2 The Viewer displays the Unattended Job Status, the Start Date and the End Date.



- 3 The drop-down list shows the jobs in various categories.

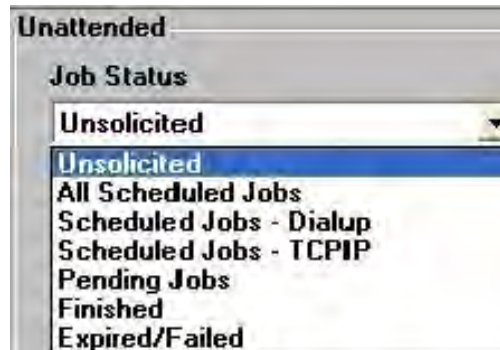

Choose the type of Unattended Jobs you want to view based on the following description:

Category	Description
Unsolicited	Accounts that were created/updated through an unsolicited call from a panel.
All Scheduled Jobs	All scheduled jobs, regardless of status.
Scheduled Jobs -Dialup	All scheduled jobs for dialup connection.
Scheduled Jobs -TCP/IP	All scheduled jobs for TCP/IP connection.
Pending Jobs	Scheduled jobs for the unattended server that are not yet executed.
Finished	Any job (unsolicited or scheduled) that is done.
Expired / Failed	Scheduled jobs that did not finish in the required time frame/ jobs that were not completed.

- 4 After choosing one of the job status options and the date information, click **Search** on the upper right of the screen to complete the selection. The scheduled jobs and their status are displayed in a grid as illustrated below:

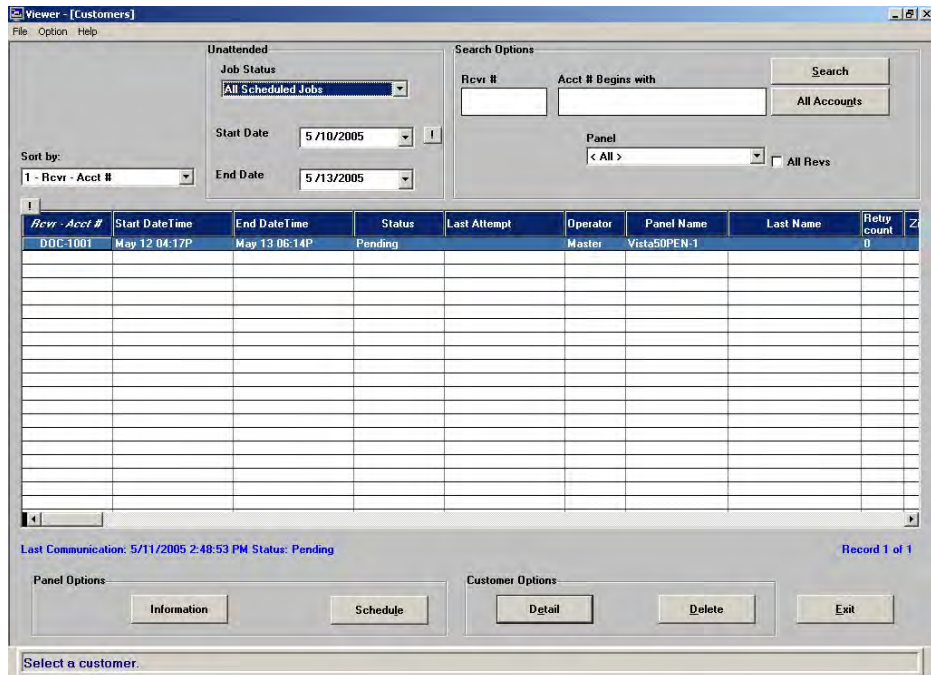

### Viewing the Commands and Activity Log Information

For information on the status of the Unattended tasks and commands, click **Information** in the Panel Options of the Unattended tasks **Viewer**.

The Unattended Batch Commands screen is displayed.

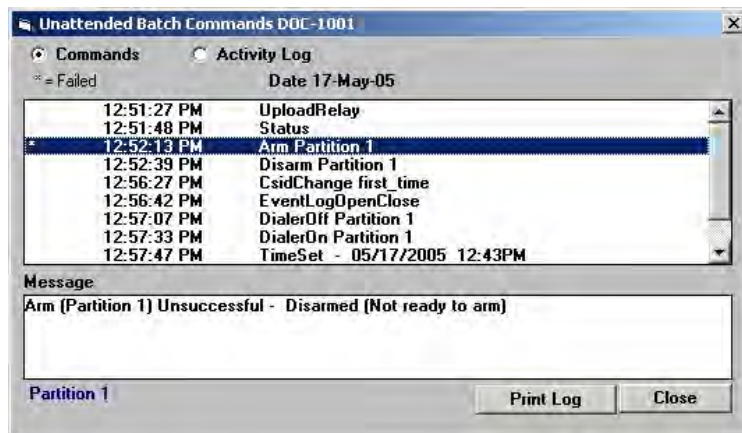

Figure 8-1 Unattended Batch Commands - Commands

Select **Commands** to see the list of jobs scheduled for the selected batch (row). Any information related to the command is displayed in the Message box.

Select **Activity Log** to display the Activity Log for the selected job. The commands that have not been executed are indicated with an “\*”.

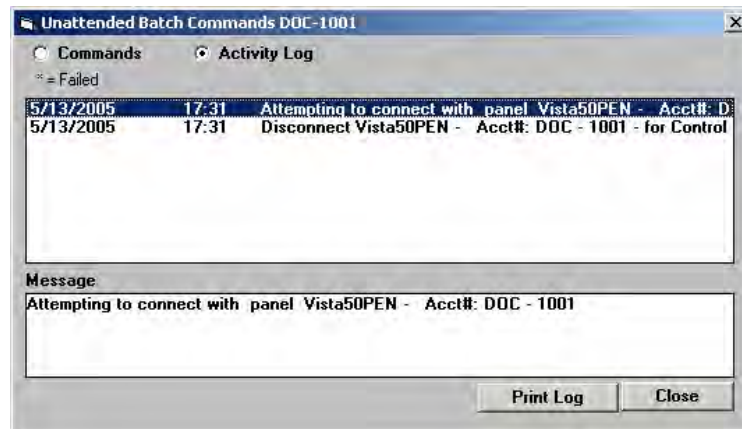

Figure 8-2 Unattended Batch Commands - Activity log

## Opening the Scheduler

Click **Schedule** under Panel Options of the Viewer screen. This option lets you open the scheduler and select more commands for scheduling.

## Viewing Customer Account Details

Click **Detail** under Customer Options of the Viewer screen to obtain the details of the customer account. The screen is not editable, but you can print it.

Figure 8-3 View Customer Detail



## 7.4 Using Unattended Mode

### Working of the Scheduled Mode

The Scheduled Mode works for Ademco, FBII, and Apex protocols as follows:

Step	Action
1	The Server checks the unattended queue for jobs to be performed in the current time frame. For example, jobs can be scheduled to occur during specific time windows, such as between 10 AM today and 3 PM tomorrow. An attempt to connect to the panel is made only during the specified time range.
2	The server picks the next job to be performed in the time period and attempts to connect to the panel.
3	If the connection to the panel fails, another attempt is made 5 minutes from the current time, then the next at 15 minutes after that, and the final attempt at 30 minutes after that.
4	After a successful connection is made to the panel, the Server performs the scheduled tasks.





#### ATTENTION

If you schedule a second job for the same account, the new job replaces the original one and only the new job appears in the queue.

### Starting the Unattended Server

To start the Unattended Server, perform the following steps:

Step	Action
1	 <p>To start the Unattended Server, click  on the Downloader Shell screen toolbar. The Launch Unattended Server dialog box is displayed.</p>



- 2 Select between Compass 16 and Compass 2.0, based on the panel being used.



**ATTENTION:** Compass 2.0 may fail to handle the calls coming from unsupported panels. In case of unsolicited mode, use separate phone lines for Compass 16 and Compass 2.0.



**TIP:** To see the list of panels supported by Compass 2.0 and panels supported only by Compass 16, click **Help** of the Launch Unattended Server dialog.

- 3 Click **OK**.  
The **Scheduler Activities Viewer** screen is displayed:

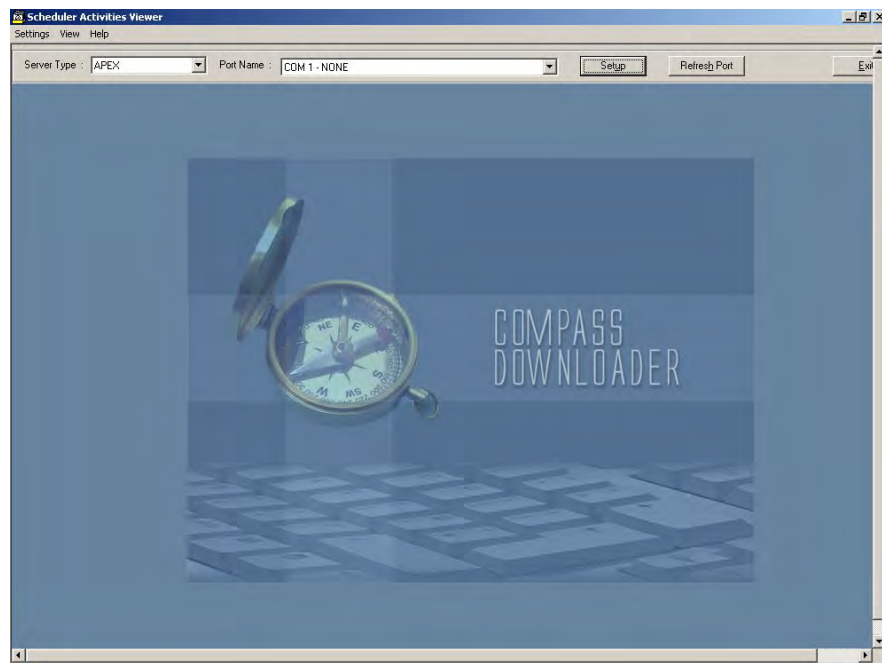

- 4 Select the **Server Type** and the **Port Name** from the drop-downs at the top of the screen.

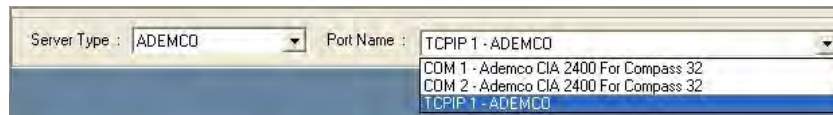

- 5 Follow the steps for individual Server types as detailed in the following sections.

## 7.5 Ademco Unattended Communications

### Setting up Ademco Unattended Mode

To set up Ademco Unattended Mode, perform the following steps:

Step	Action
1	Follow the steps for starting the unattended server as detailed in <a href="#">Starting the Unattended Server</a> .
2	Select the Server Type as <b>Ademco</b> and select the corresponding Port Name.
3	Click <b>Setup</b> . The following screen is displayed:

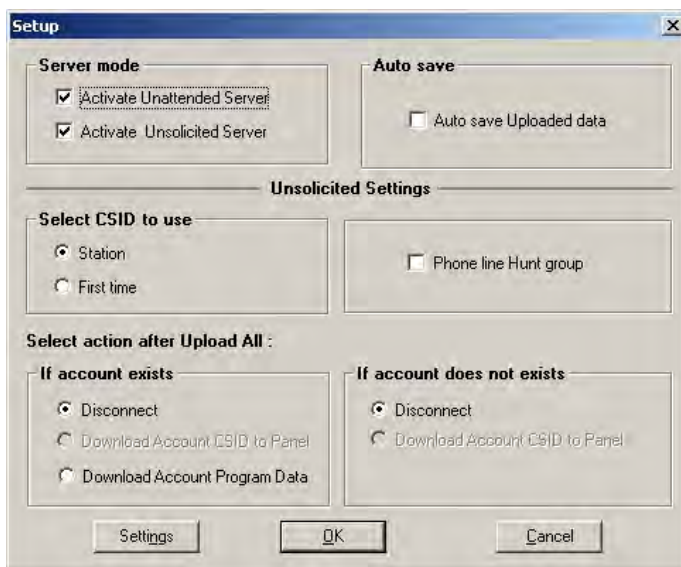



4 Configure the settings as detailed below:

Setting	Description
Server mode	Select the server you want to activate—Unattended or Unsolicited. Selecting both gives you the Mixed mode.
Auto Save	Selecting this option enables the unattended server to save all the uploaded data from the panel automatically to the database. You need not save it from panel application each time an upload happens during unsolicited or unattended mode.
Select CSID to use	Based on whether you are connecting with an unprogrammed panel, or a panel that is already downloaded, select <b>First Time</b> or <b>Station</b> .   <b>ATTENTION:</b> If this is not correctly selected, it affects the Incoming call and CPC connection.
Phone line Hunt group	This option only affects panels that require callback and if you are using multiple unattended servers on a phone line hunt group.  If a PC initiated Unattended batch connection is attempted and the panel requires callback, the CSID for the specific account is saved along with the time that the panel hung up to do the callback. The panel then calls back in 35 seconds.  If a phone line hunt group is used, the panel may call back to a different unattended server. The unattended server answers the call and finds out that it is a response to a call that the PC had initiated 35 seconds back.  The server tries to save the CSID instead of the default CSID usually attempted for unsolicited uploads.  All PCs running as unattended servers must have their clocks set accurately within one minute of each other.
Select action after Upload All:	
If account exists:	Select one of the following:
Disconnect	Disconnect from Panel
Download Account CSID to Panel	Download the Account CSID information from the PC to the panel
if account does not exist:	Select one of the following:
Disconnect	Disconnect from Panel

Download Account CSID to Panel

Download the Account CSID information from the PC to the panel

5 Click **OK**.

The COM Port is started. The Subscriber Information, Panel Information, details of the scheduled jobs, and the Activity Log are displayed in the **Scheduler Activities Viewer**.

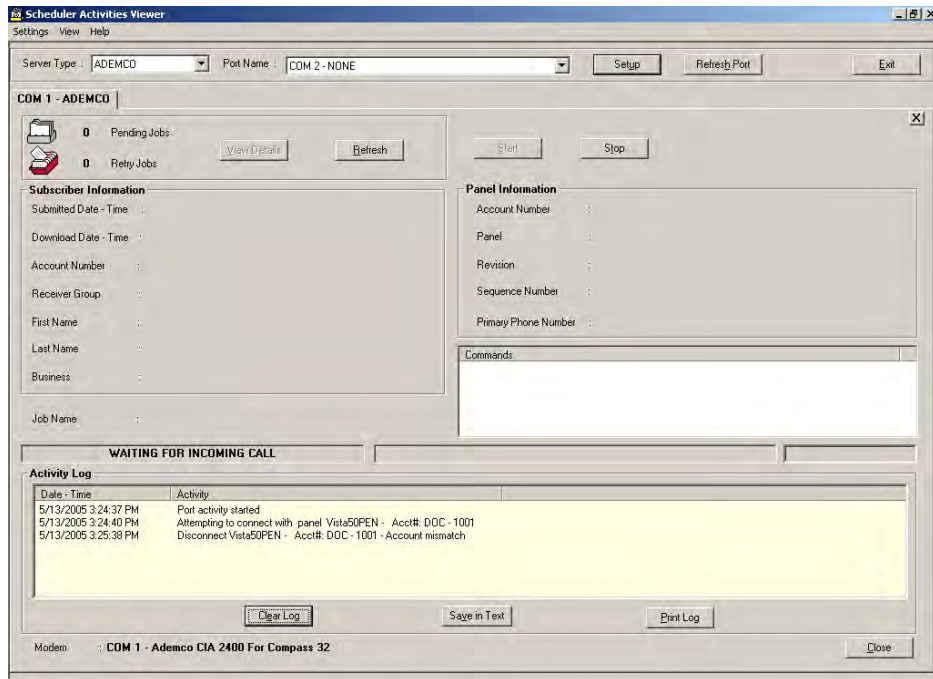

**Figure 8-4 Scheduler Activities Viewer - Activity Log**

6 You can **print** the Activity Log, **save** it as a text file or simply **clear** it from the screen using the relevant buttons at the bottom of the screen.

7 To stop the activity of the Com Port, click the **Stop** button above **Panel Information**.

To restart, click **Start**.

The Setup screen is again displayed for configuration.

## Scheduling Ademco Unattended Jobs

To schedule Ademco Unattended jobs, perform the following steps:

Step	Action
1	Follow the steps for starting the unattended server as detailed in <a href="#">Starting the Unattended Server</a> .
2	To schedule an unattended job, click the account in the Customer grid. Click the <b>Schedule</b> button located in the Panel Options area of the screen. The <b>Scheduler</b> is displayed as illustrated below:

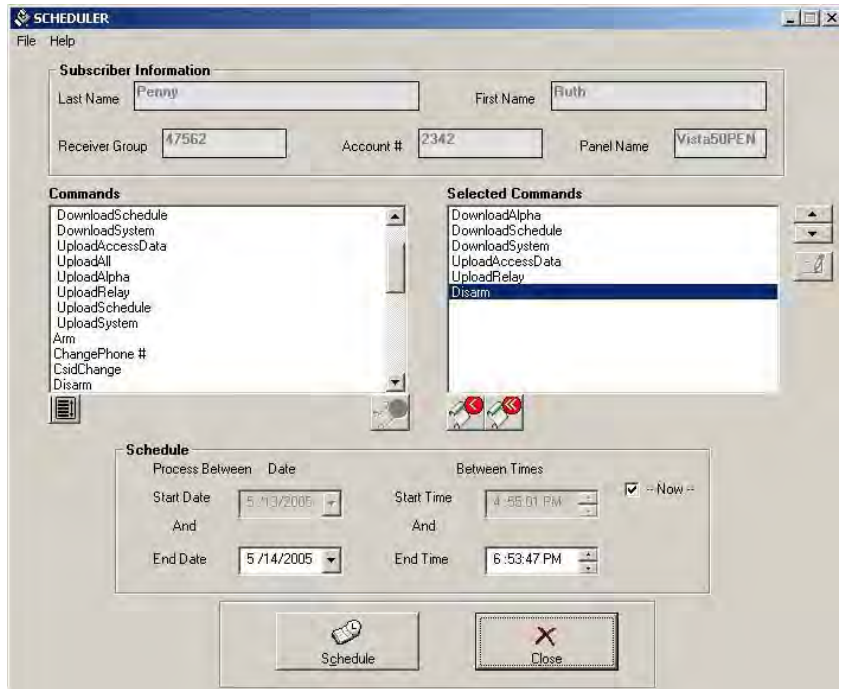

- 3 Select the commands to be scheduled and move them to the **Selected Commands** list.



**REFERENCE- INTERNAL:** For more information on selecting commands, refer to 8.1 Selecting a Command.

- 4 Select the start and end dates, and the start and end times.

- 5 Click **Schedule**.  
The following screen is displayed:

The screenshot shows a window titled "Communications" with the following settings:

- Connection Details:**
  - Initiate From: PC (dropdown menu)
  - Answering Machine Defeat
  - Increase Priority
  - Enable TCP/IP
  - Use Account CSID
  - First Time Communication
  - Acct # in Panel
- Panel Phone:**
  - Panel Phone: 00113871237 (text field)
  - Buttons: Save, Undo
- Buttons:** Schedule, Cancel

- 6 Note that **PC** and **Panel** are the only "Initiate from" options available here. Select one of them, based on whether you want the call to be made by the PC, or the Panel.
- 7 Select the **Answering Machine Defeat** and **Increase Priority** options if required.



**ATTENTION:** When you select the **Increase Priority** option, the job is placed high on the list of tasks and run before other less priority jobs. This feature is applicable only for Unattended mode.

- 8 Type the Panel Phone number.



**TIP:** To save this phone number, click Save.

If this phone number is for this session only, and you do not want to overwrite an already saved number, click **Undo** at the end of the session. The previous phone number is retained.

- 9 To use the TCP/IP connection, select **Enable TCP/IP**.

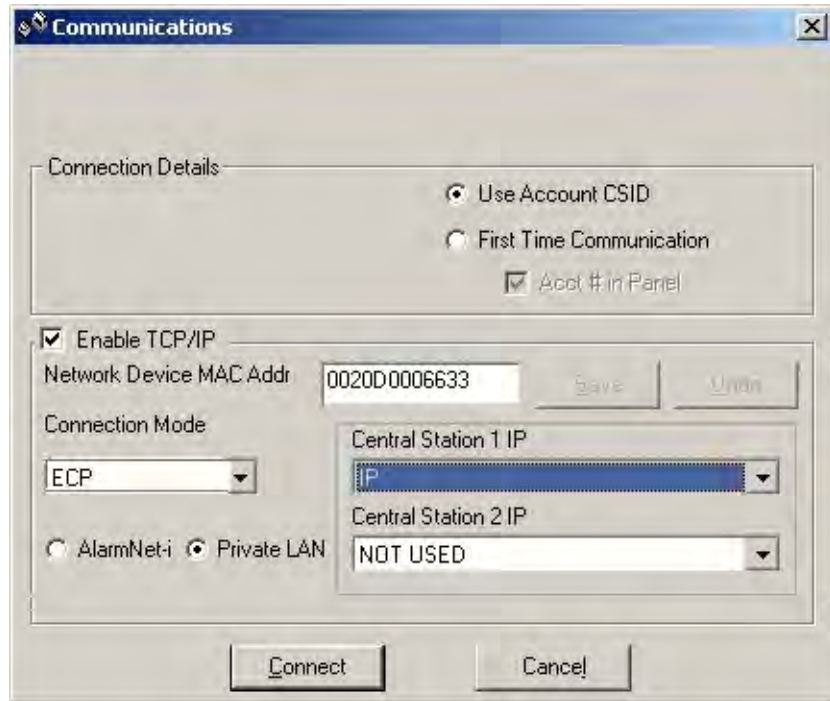

- 10 Select the required option for **Connection Mode** - Direct Wire or ECP, based on whether you want to connect to the Panel through Direct Wire or through ECP.
- 11 If you want to communicate over the Intranet, select the option **Private LAN** and select **Central Station 1 IP** and/or **Central Station 2 IP** from a list of the 7810iR Device names that you have configured through File -> Device and Computer Names/ IP Addresses.



**REFERENCE- INTERNAL:** For more information, refer to [2.4 Mapping Devices to IP](#).

- 12 If you want to communicate with the panel over the Internet (through AlarmNet-i Control Server), select the option **AlarmNet-i**.



**REFERENCE- INTERNAL:** For information on configuring the Alarmnet-i URL, refer to [2.2 Setting up the Modem](#).

- 13 Click **Schedule**.
- 14 The scheduled tasks are taken up and completed on priority. You can view the details of the processing in the Activity Log of the **Scheduler Activities Viewer**.

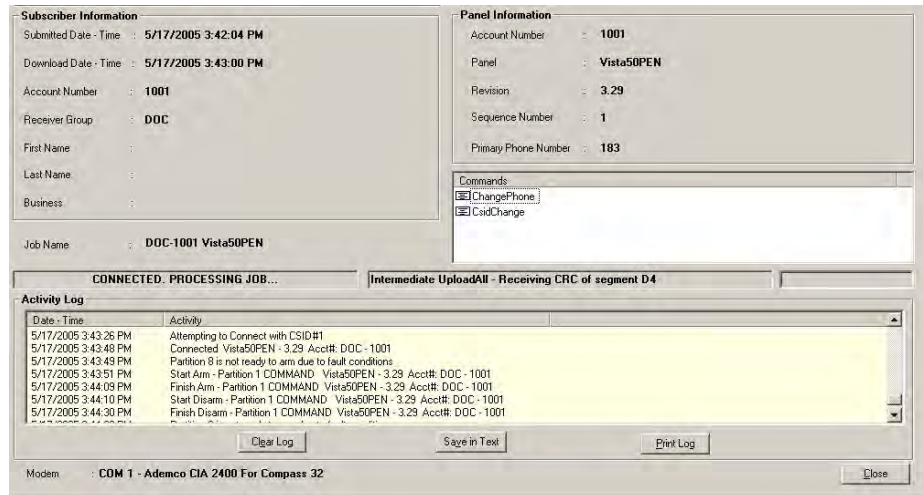

15 The **Viewer-[Customers]** screen shows the status of the batch. For information on the individual tasks, click **Information**. Click **Commands** to see the status of commands execution. Click **Activity Log** to see a listing of all the activities since the batch was scheduled.



**REFERENCE– INTERNAL:** For more information on accessing the Viewer screen, refer to 7.3 Viewing Scheduled Jobs .

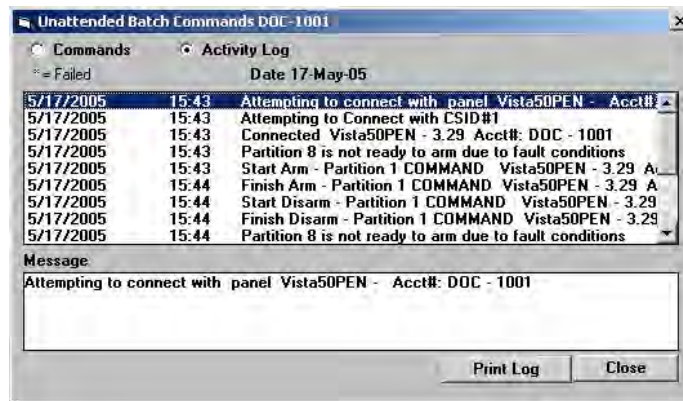

## How the Ademco Unsolicited Mode works

### Preparing the Server to Receive Unsolicited calls

To prepare an Ademco server to receive unsolicited calls, perform the following steps:

Step	Action
1	Start the unattended server as detailed in <a href="#">Starting the Unattended Server</a> .
2	Select the Server Type as <b>Ademco</b> and select the corresponding Port Name.
3	Select <b>Unsolicited Server</b> in <b>Server Mode</b> .

- 4 Select the action to be taken when the panel calls in.  
The Unsolicited Setup Screen prompts the operator to define the actions that the Server must perform after uploading data from the panel (described in section [Setting up Ademco Unattended Mode](#) ).

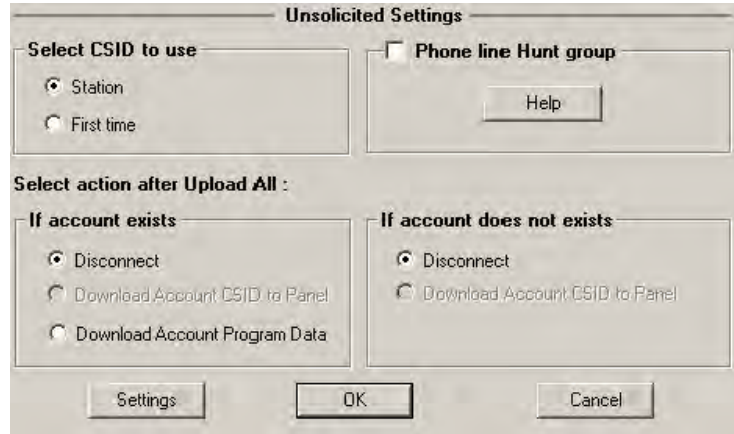

- 5 Start the Server in Answer mode so that any incoming calls are answered.

**Working of the Ademco Unsolicited Mode**

Step	Action
1	The panel calls the Compass Downloader.
2	The server identifies the panel type, and the panel information is uploaded to the server.
3	The server extracts the primary phone number information just uploaded and determines if a receiver group is assigned to that phone number. It checks for this within the Receiver Group/CS Phone number table previously set up by the operator.
	 <b>REFERENCE- INTERNAL:</b> For more information on Receiver Group assignment, refer to <a href="#">7.2 Assigning Receiver Groups</a> .
4	If the primary phone number has a receiver group assigned to it, then the assigned receiver group together with the account number sent from the panel is defined as the unique Compass Account number within the Downloader. If the account already exists, and the panel type is correct, unsolicited operation continues. If this unique Compass Account number does not exist in the Downloader, then the Downloader generates a new number.
5	If a primary phone number does not have a receiver group assigned to it, then the receiver group is assigned a value of "??????", indicating that this record is incomplete. The defined Compass Account number is "??????" and the account number sent from the panel. Note that this defined Compass Account may not be unique. If this unique Compass Account number does not exist in the Downloader, then the Downloader generates a new number.

- 6 After a Compass Account has been identified, the Server checks for jobs scheduled to be done with the panel initiated option and those tasks are executed based on priority.  
If no jobs are found, it performs actions pre-defined by the operator in the Unsolicited Setup screen.

## Setting Up an Ademco Panel to Call an Unsolicited Server

To setup an Ademco panel to call an unsolicited server, perform the following steps:

Step	Action
1	Program the primary phone number, account number, and download phone number in the Ademco panel.

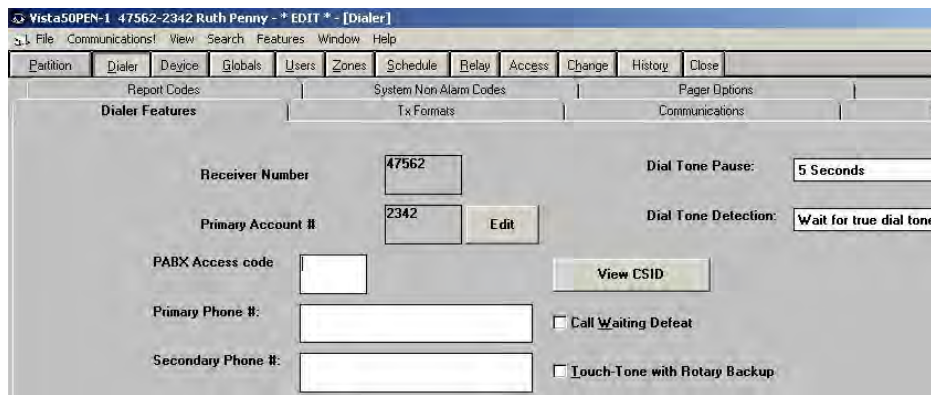

- 2 Ensure that the primary phone number has a receiver group assigned to it within the Downloader.



**ATTENTION:** This phone number field does not take any characters other than numbers.



**REFERENCE– INTERNAL:** For more information on Receiver group assignment, refer to 7.2 Assigning Receiver Groups.

During the handshake between the Server and the Ademco panel, the Ademco panel passes the programmed account number.



After the connection between the Server and the Ademco panel is established, the Server requests an upload so that it can retrieve the primary phone number programmed. As mentioned above, the Server uses the primary phone number and account number programmed to determine the Compass Account.



## 7.6 FBII Unattended Communications

### Setting up FBII Unattended Mode

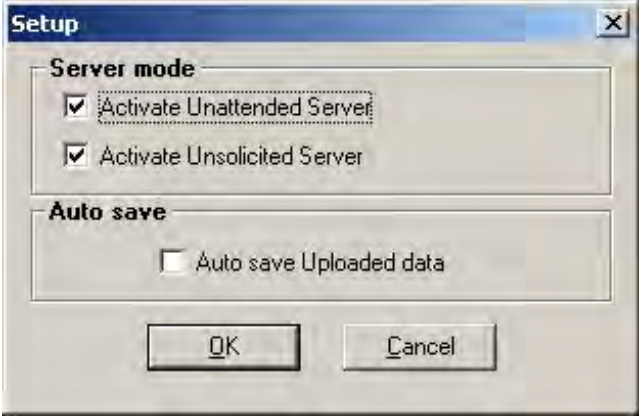
To select FBII Unattended Mode, perform the following steps:

Step	Action
1	Start the Unattended Server.   <b>REFERENCE– INTERNAL:</b> Refer to <a href="#">Starting the Unattended Server</a> .
2	Select the Server Type as <b>FBII</b> from the drop-down list and select the appropriate port.
3	Click <b>Setup</b> . The following dialog box is displayed:  
4	Select the required options and click <b>OK</b> .   <b>REFERENCE– INTERNAL:</b> For more information on the options, see <a href="#">Step 4 of Setting up Ademco Unattended Mode</a> .

### Scheduling FBII Unattended Jobs

To schedule FBII Unattended jobs, perform the following steps:

Step	Action
1	Start the Unattended server.   <b>REFERENCE– INTERNAL:</b> Refer to <a href="#">Starting the Unattended Server</a> .
2	To schedule an unattended job, click the account in the Customer table. Then click the <b>Schedule</b> button located in the Panel Options area of the screen. The <b>Scheduler</b> is displayed.

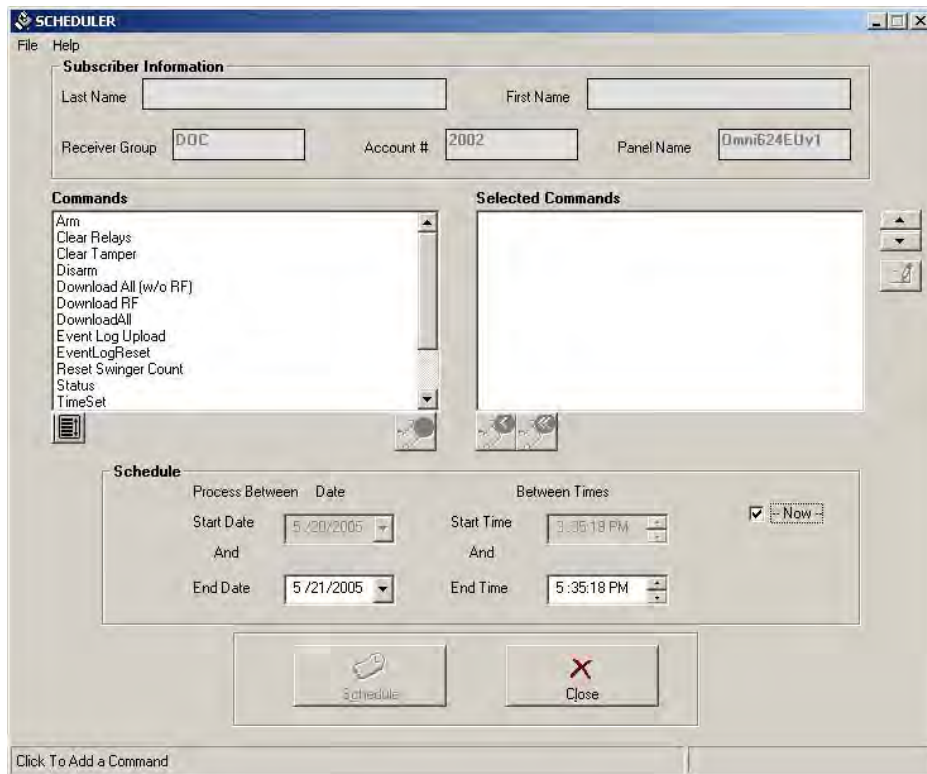

- 3 Select the commands to be scheduled and move them to the **Selected Commands** list.



**REFERENCE- INTERNAL:** For more information on selecting commands, refer to 8.1 Selecting a Command.



**ATTENTION:** Note that the FBII protocol does not allow selection of some of the commands multiple times, unlike Ademco. However, you can select any number of different commands.

- 4 Select the start and end dates, and the start and end times.
- 5 Click **Schedule**.  
The **Communications** screen is displayed.



- 6 In Connection Details, select the options as required.  
The 2 Call Method is the same as Answering Machine Defeat in Ademco.



**TIP:** When you select the Increase Priority option, the job is placed high on the list of tasks and run before other less priority jobs. This feature is applicable only for Unattended mode.



**REFERENCE– INTERNAL:** For more information on Answering Machine Defeat , refer to Configuring for Answering Machine Defeat.

- 7 Type the Panel Phone number, and click **Schedule**.

### How the FBII Unsolicited Mode works

The FBII unsolicited mode of working is as follows:

Step	Action
1	The Unattended Server is started, and listens for incoming calls.
2	The panel calls in.
3	The server identifies the panel type and extracts the Unattended ID from the panel. The Unattended ID from the panel is used for locating the correct Compass Account within the Downloader.
4	After the Compass Account is found, the server downloads the Compass Account data to the panel.
5	The scheduled jobs are executed.

### Setting up the FBII Panel to Call Unsolicited Server

The FBII panel can call the Unsolicited server if the Unattended Account ID number is programmed in the FBII panel Dialer. This value is retrieved from an existing Compass Account.

To ensure that the right Account ID is programmed, perform the following steps:

Step	Action
1	In the Compass Customer Screen, find or create the Compass Account of interest.

- 2 Highlight the Compass Account and press the following keys: <Shift>+<Ctrl>+?. The account information is displayed as below.

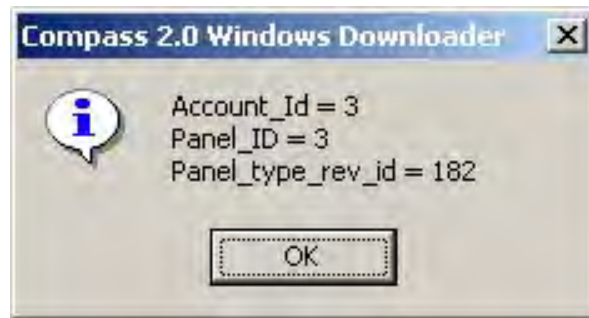

- 3 Verify that the Account ID value is the same as the unattended ID value in the FBII panel's Dialer. After this is done, the FBII panel can call the Server at any time.



**ATTENTION:** In the Panel Dialer, the account ID must be exactly 12 digits. If the Account\_Id is 4, the number in the panel would be 000000000004.

## 7.7 Apex Unattended Communications

### Starting Apex Unattended Mode

To start Apex Unattended Mode, perform the following steps:

Step	Action
1	Start the Unattended Server.
	 <b>REFERENCE– INTERNAL:</b> Refer to <a href="#">Starting the Unattended Server</a> .
2	Select the Server Type as <b>Apex</b> from the drop-down and select the appropriate port.
3	Click <b>Setup</b> . The following dialog box is displayed:

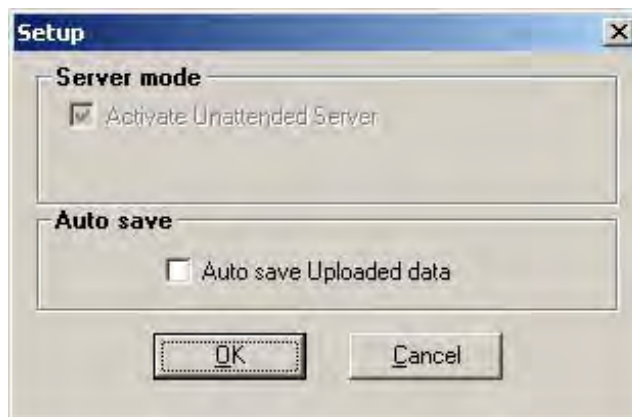

- 4 Select **Auto Save Uploaded data** and click **OK**.

## Scheduling Apex Unattended Jobs

To schedule Apex Unattended jobs, perform the following steps:

Step	Action
1	Start the Unattended server.
2	To schedule an unattended job, click the account in the Customer grid. Click the <b>Schedule</b> button located in the Panel Options area of the screen.
3	The Scheduler is displayed.

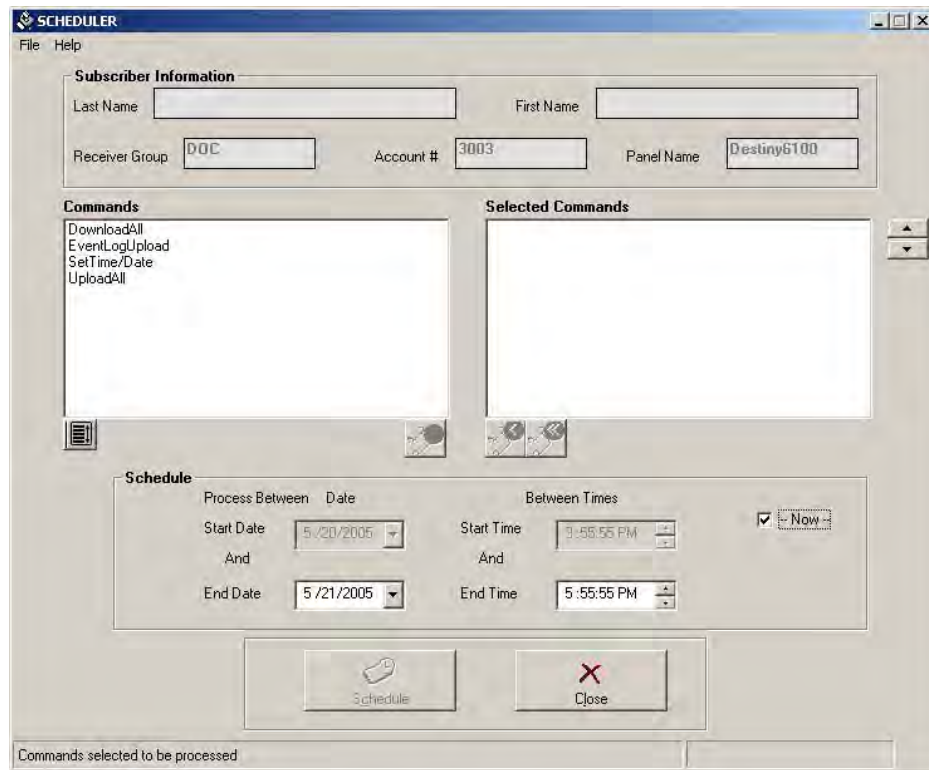

- 4 Select the commands to be scheduled and move them to the **Selected Commands** list.



**REFERENCE- INTERNAL:** For more information on selecting commands, refer to 8.1 Selecting a Command.

- 5 Select the Start and End Dates and Start and End Times in **Schedule**.

- Click the **Schedule** button at the bottom of the screen. This button is enabled only if any commands are selected.

The following screen is displayed:

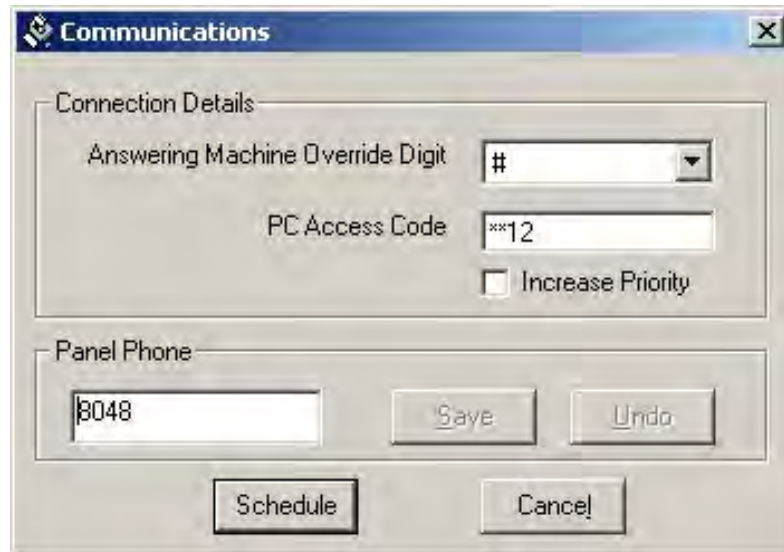

The screenshot shows a dialog box titled "Communications". It contains two main sections: "Connection Details" and "Panel Phone". In the "Connection Details" section, there is a dropdown menu for "Answering Machine Override Digit" set to "#", a text field for "PC Access Code" containing "\*\*12", and an unchecked checkbox for "Increase Priority". In the "Panel Phone" section, there is a text field containing "8048", a "Save" button, and an "Undo" button. At the bottom of the dialog, there are "Schedule" and "Cancel" buttons.

- Type the Panel Phone number, and select the **Answering Machine Override Digit**.

The PC Access Code is passed internally, so you need not type it.



**ATTENTION:** When you select the **Increase Priority** option, the job is placed high on the list of tasks and run before other less priority jobs. This feature is applicable only for Unattended mode.

- Click **Schedule**.

## 8. On-Line Commands

Irrespective of whether the panel is Ademco, FBII, or Apex, many on-line commands are common across them. All the commands may not be valid for all the panels.

These commands are common for the Interactive mode and the Unattended mode. The only difference is that in the Unattended mode the screens asking for user input during command execution are not displayed.

Instead, the Command Details screen is displayed during the scheduling.







### REFERENCE- INTERNAL



For more information on Command Details, refer to [Single Window for Configuring Multiple Commands](#).

### 8.1 Selecting a Command

You can select and de-select commands using the following buttons:

Button	Click this to...
	Move commands to the Selected Commands list.  <b>TIP:</b> You can also select a command by double-clicking the command, or using the drag-and-drop method described in section 1.4 of this user guide.
	Move commands from the Selected Commands to the Commands list.
	Move all commands from the Selected Commands to the Commands list.

### Other Tools

Tool	Use this to...
	Stop the execution, and cancel the command. This is enabled when the selected commands are being processed. It is placed below the Selected Commands list. This is not available in the Unattended mode.   <b>ATTENTION:</b> This button is disabled for some lower end panels.



Remove the completed or failed tasks from the Selected Commands list.

It is placed below the Selected Commands list. This is not available in Unattended mode.



Deselect all the highlighted commands at once.

It is placed below the Commands list.



Edit a selected command.

It is placed to the right of the Selected Commands list.



**ATTENTION:** This tool is enabled only when the user input is taken for a command as in Arm/Disarm or Timeset. It is disabled for other commands.



Move the selected commands up or down to prioritize a task.

It is placed to the right of the Selected Commands list.

## 8.2 List of Commands

A comprehensive list of commands and their description is provided in the following table:

Command	Description
Arm	Arm the panel from the downloader. You have to specify the area, when prompted
ChangePhone	Change the download phone number
Clear Relays	Clear relay information
Clear Tamper	Clear tamper information
Clear Zone Lockouts	Clear zone lockouts information
CsidChange	Change the Central Station ID
DialerOff	Switch-off dialer from the monitoring station
DialerOn	Switch-on dialer from the monitoring station
DirectConnect	Connect the downloader to the panel by a RS232 cable
Disarm	Disarm the panel from the downloader. You have to specify the area, when prompted.
Download All (w/o RF)	Download all information except the RF data
Download All (w/o User Codes)	Download all information except the user codes
Download All (w/User Codes)	Download all information, including the user codes
Download Ambush	Download ambush details
Download Auto Arming Times	Download auto arming times details
Download BA Options	Download burglary alarm details



Download Comm	Download communication details
Download Ctrl Set Options	Download control set options details
Download Device Options	Download options configured for the device
Download Group	Download group details
Download Holiday	Download holiday schedules
Download Keypad Information	Download keypad information to the panel
Download Loop / Point	Download loop and points details
Download Pass Code	Download pass code details
Download RF	This command is used only when the optional RF Expander module is installed
Download Temporary Schedule	Download temporary schedules to the panel
Download User Codes	Download only user codes to the panel
DownloadAccessData	Download access data to the panel
DownloadAlarmTypes	Download alarm type data to the panel
DownloadAll	Download all programming information to the panel
DownloadAlpha	Download panel Alpha display strings
DownloadRelay	Download relay information to the panel
DownloadSchedule	Download all schedule information to the panel
DownloadSystem	Download system information to the panel
Download TroubleTypes	Download trouble type details
ECPList	Upload ECP device details
Engineer Reset	Perform Engineer reset to control panel
EventLogAlarms	Get event log regarding alarms from panel
EventLogAll	Get event log regarding all events from panel
EventLogBypasses	Get event log regarding bypasses from panel
EventLogClear	Clear an existing event log from the panel
EventLogOpenClose	Upload event log of Open/Close details
EventLogReset	Clear all events in the control panel
EventLogSystem	Get event log regarding system events from panel
EventLogTested	Get event log of system test events
EventLogTroubles	Get event log regarding troubles from panel
EventLogUpload	Upload an event log from the panel

---

FireTest	Upload the fire test results from panel
Message	Send message for display on panel
PhoneLockOutOff	Prevent users from changing the Primary phone number
PhoneLockOutOn	Allows users to change the Primary phone number
PointBypass	Bypass a point
ProgrammableOutput	Turn a programmable output device ON or OFF
RelayBurglary	Report burglary to the monitoring station
RelayFire	Report incidence of fire to monitoring station
RelayOpenClose	Trigger Open/Close relay
RelayPanic	Trigger panic relay
RelayRemoteSiren	Trigger remote siren relay
Reset Swinger Count	Clear swinger count
Set Relay	Set a relay
Shutdown DialerOff	Shut down the panel dialer functionalities (suspend the Dialer operation in a panel)
Shutdown DialerOn	Restore operation of panel dialer functionalities
Shutdown SystemOff	Shutdown the system functionalities. (suspend panel operations)
Shutdown SystemOn	Restore panel operations
SilenceReset	Disarm the panel
SounderOff	Switch off the sounder
SounderOn	Switch on the sounder
Status	Get the status of the panel that is on-line with the downloader
StatusAlarms	Get the Alarms status in the panel
StatusAlarmsHistory	Get the Alarms history status in the panel
StatusBypasses	Get the Bypass Status in the panel
StatusFaults	Get the Faults status in the panel
StatusLowBattery	Get the LowBattery Status in the panel
StatusTroubles	Get the Troubles Status in the panel
StatusTroublesHistory	Get the TroublesHistory Status in the panel
TimeRead	Read the time from the panel
TimeSet	Set the time to the panel

UnBypassZone	Unbypass a zone
Upload All (w/o RF)	Upload all information other than RF details from the panel
Upload Ambush	Upload ambush details
Upload Auto Arming Times	Upload auto arming times from the panel
Upload BA Options	Upload burglary alarm details from the panel
Upload Comm	Upload communication details
Upload Ctrl Set Options	Upload control set options from the panel
Upload Device Options	Upload device options from the panel
Upload Group	Upload group details from the panel.
Upload Holiday	Upload holiday schedules from the panel.
Upload Keypad Information	Upload keypad information from the panel
Upload Loop / Point	Upload loop and point details
Upload Pass Code	Upload pass code details
Upload RF	Upload RF data. This command is used only when the optional RF Expander module is installed.
Upload Temporary Schedule	Upload temporary schedules from the panel
Upload User Codes	Upload only user codes from the panel
Upload Zone Info 1	Upload information regarding zone 1
Upload Zone Info 2	Upload information regarding zone 2
Upload Zone Info 3	Upload information regarding zone 3
Upload Zone Info 4	Upload information regarding zone 4
Upload Zone Info 5	Upload information regarding zone 5
Upload Zone Info 6	Upload information regarding zone 6
UploadAccessData	Upload access data from the panel
UploadAlarmTypes	Upload alarm type data from the panel
UploadAll	Upload all programming information from the panel
UploadAlpha	Upload panel Alpha display strings
UploadRelay	Upload only relay information from the panel
UploadSchedule	Upload schedule information from the panel
UploadSystem	Upload system information from the panel
Upload TroubleTypes	Upload trouble type details
Zone Status	Get the status of the zone. Specify the zone.

ZoneBypass

Bypass faulted zones via the downloader. Specify the zone.

### 8.3 Descriptions

Some commands, such as Timeset, Arm, or Bypass, require additional information (like the time to be set, or area to be armed). A separate dialog box is displayed on selecting these commands, asking for user input.

#### Changing CSID and Phone Number – Ademco

You can change the existing CSID or the Phone Numbers using the **CsidChange** and **ChangePhone#** Commands in the Scheduler.

#### Changing CSID

To change CSID, perform the following steps:

Step	Action
1	Double-click <b>CsidChange</b> in the Scheduler Commands list in the Scheduler to select it. The <b>Change CSID</b> dialog box is displayed.



2 Select your option based on the guideline below:

Option	Description
CSID in Station Data	CSID that exists under File/Station Data.
CSID in Account Record	CSID that was saved in the Modify screen (panel).
First time CSID	Default CSID of the panel.
Choose CSID	Enter any 8-digit CSID.

3 Click **OK**.

## Changing the Phone Number

To change phone number, perform the following steps:

Step	Action
1	Double-click <b>ChangePhone#</b> in the Scheduler Commands list to select it. The <b>Change Phone Number</b> dialog box is displayed.

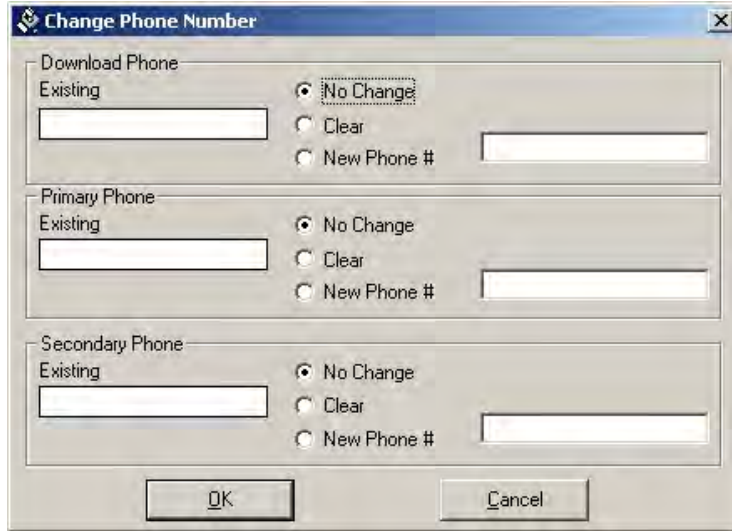

- 2 The existing phone number for this panel is displayed on the left side of the Change Phone Number screen.  
For each phone number, the Operator can:  
keep the phone number as is (**No Change**)  
clear the phone number (**Clear**), or  
change the phone number (**New Phone #**)  
In case **New Phone #** is selected, type the new number in the box provided.
- 3 Click **OK**.

## Displaying Messages

To display messages on the panel, perform the following steps:

Step	Action
1	Double-click <b>Message</b> in the Scheduler Commands list to select it. The <b>Message</b> dialog box is displayed.

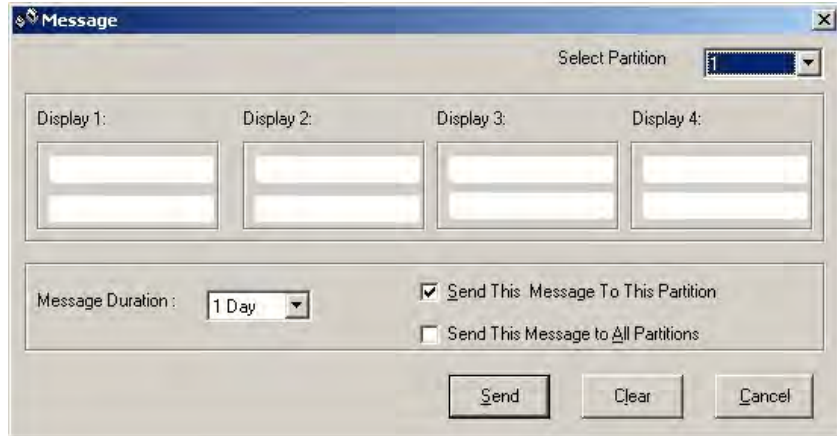

- 2 Type the messages that need to be displayed on the panel, and select the message duration.  
You have a choice of sending the message to the single partition selected in **Select Partition** or all the partitions.
- 3 Click **Send** to send the message to the panel.

## Arming/Disarming

To arm or disarm a partition, perform the following steps:

Step	Action
1	Select <b>Arm</b> or <b>Disarm</b> as required. The Partition Selection dialog box is displayed.

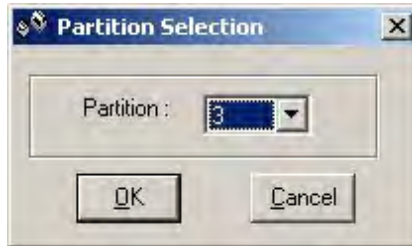

**Figure 9-1 Arm/Disarm - Ademco**

In FBII panels Arm/Disarm is a single option. The arm/Disarm dialog box is displayed.



**Figure 9-2 Arm/Disarm - FBII**

- |   |   |
|---|---|
| 2 | Select <b>OK</b> (Ademco) or <b>Select</b> (FBII) as the case may be. |
|---|---|

## Setting the Time

To set the time in the panel, perform the following steps:

Step	Action
1	From the list of commands in the Communication screen, select <b>Timeset</b> .

- 2 Double-click **Timeset** or click the green arrow below the Commands list. The following screen is displayed:

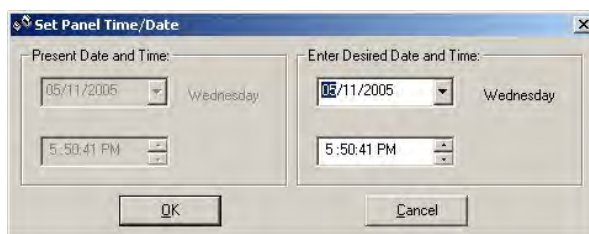

**ATTENTION:** FBI and Apex protocols do not offer the option of entering the desired date and time. They use the Present Date and Time by default.



**TIP:** In Guardian Panels, the time and date are displayed automatically according to the time zones programmed in the panel.

- 3 The current date and time is displayed by default under both **Present Date and Time**, and **Enter Desired Date and Time**. While you cannot make changes to the former, the Desired date and time section allows editing.
- 4 Click **OK**.



## Viewing Event Log (Ademco)

To view Event Log in Ademco panels, perform the following steps:

Step	Action
1	Select <b>EventLogAll</b> from the list of commands. The <b>Get EventLog From Panel</b> dialog box is displayed.

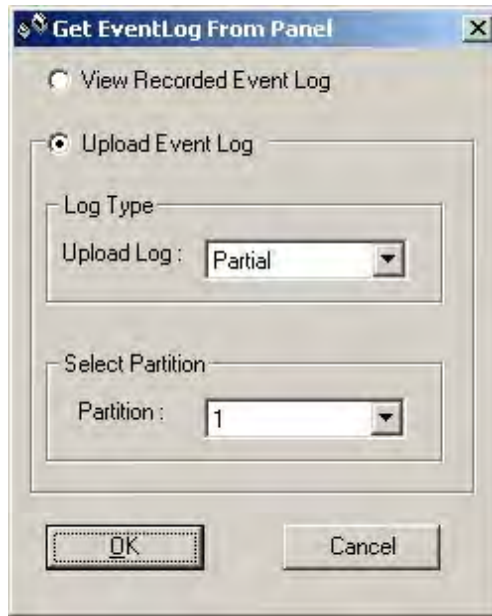

**ATTENTION:** In case of non partition or if only one partition is selected, the **Select Partition** option is not displayed.

- 2 You have the option of viewing the log, or uploading it.  
If Upload Event log is selected, you can specify if you want a partial upload or a full upload.
- 3 Select the partition on which the command is to be executed.
- 4 Click **OK**.

## Shutting Down a Panel (Ademco)

To shut down an Ademco panel, perform the following steps:

Step	Action
1	Select the required shutdown command from the list of four shutdown commands available.

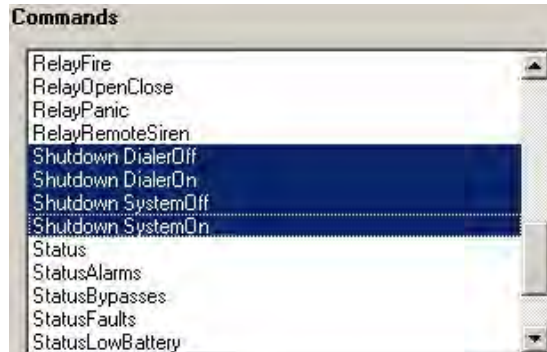

- 2 Double-click the command or click the green arrow below the commands list. The following screen is displayed:

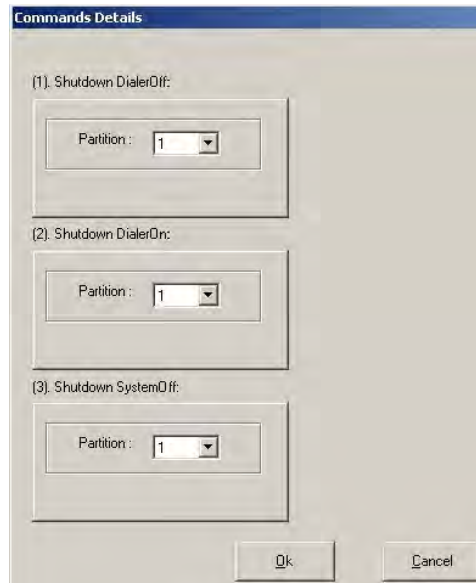

**ATTENTION:** Although you have selected four commands, only three are shown here. This is because the third one is Shutdown SystemOff. After this command is executed, the panel gets disconnected and we cannot execute any more commands

- 3 Select the partition for which the operation is to be performed.
- 4 Click **Ok**.



**ATTENTION**

After the Shutdown System ON/OFF connection is executed, the panel is disconnected from the Compass. After Shutdown SystemOff, the panel operation is suspended.

**Bypassing a Zone**

To bypass a zone, perform the following steps:

Step	Action
1	Select the <b>ZoneBypass</b> command. In Ademco Panels, the Zone Bypass dialog box is displayed.

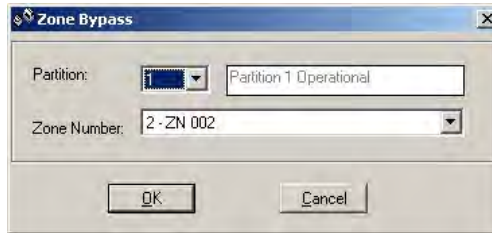

In FBII, the dialog box displayed does not ask for a partition selection.



- 2 Select the Partition and the Zone number to be bypassed if the panel is Ademco, or only the Bypass Zone in case of FBII.
- 3 Click **OK** or **Select** as the case may be.

## Sending a Test Report (Ademco)

To send a Test Report, perform the following steps:

Step	Action
1	Select <b>TestReport</b> from the list of Commands in the Communication screen/Scheduler.
2	Double-click the command or click the green arrow below the commands list. The <b>Request Test Report</b> screen is displayed.

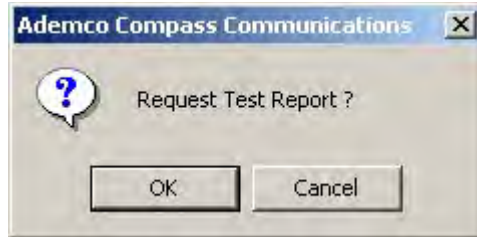

3 Click **OK**.



**TIP** :During the processing of the request, you will see a '\*' to the left of TestReport, which turns to a '#' after the command is processed. If the command is not executed, the failure status is indicated by an '&'.

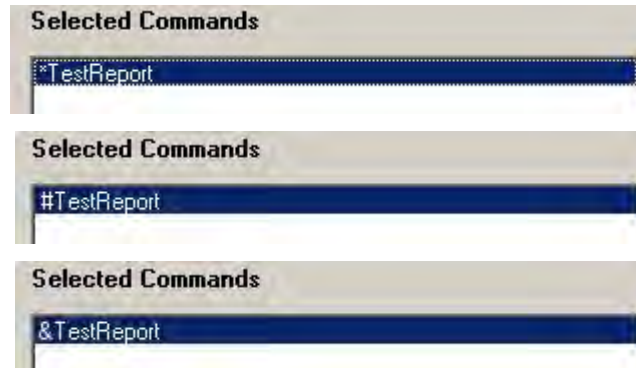

## 9. Database Management Utility

### 9.1 Overview

The Compass2.0 database contains information about configuration details for the intrusion control panel. It is essential that a backup of the information is taken on a regular basis. This chapter describes how to switch over the databases, backup, and restore the Compass2.0 database.



#### ATTENTION

The change, backup, and restore operations requires access to the SQL Server. It is recommended to close all Compass2.0 applications that are open when the Database Management Utility operations are performed.

### 9.2 Change Database

If you have data stored across multiple databases or servers and if you want to switch between them, use the change database option



#### ATTENTION

When you change your database, the previous database data is not affected. You can again change the database to go back to the previous, if necessary.

To change databases, perform the following steps:

Step	Action
1	Choose <b>Start &gt; All Programs &gt; Compass Windows Downloader &gt; DatabaseManagementUtility</b> . The <b>Database Management Utility</b> dialog box appears.

- 2 Select **Change Database** option. The details of the active Compass database are displayed under **Existing Database Option**. The information is read only.

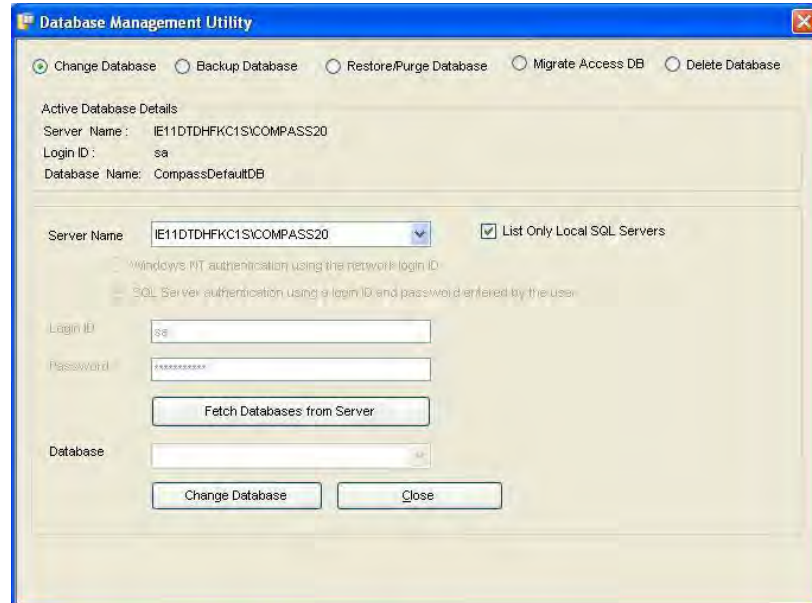

- **Server Name** - The name of the computer in which the active Compass database resides.
  - **Login ID** - The login ID using which you can login to the SQL server.
  - **Database Name** – The active Compass database name.
- 3 From the drop down list, select the name of the computer where the database you would like to switch to resides.

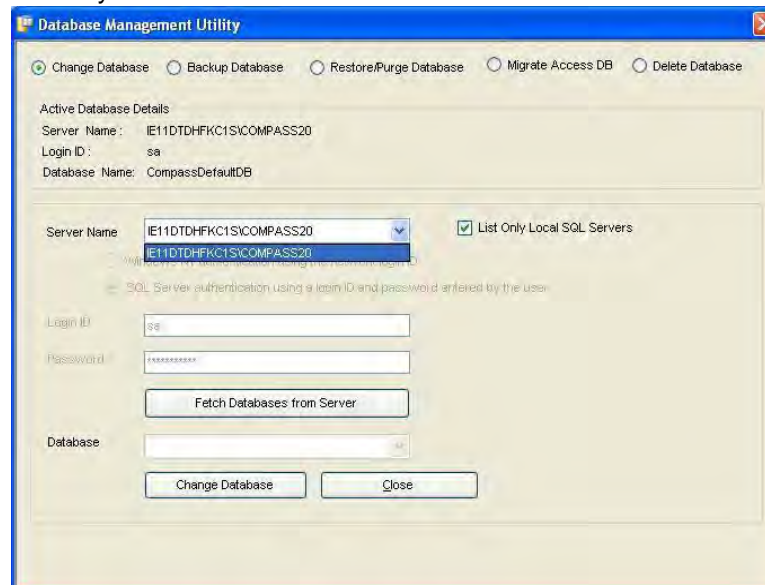

- 4 Select the **List only local SQL Servers** check box to view all the servers in the local computer. To view all the servers in the network, clear the **List only local SQL Servers** check box.
- 5 Select one of the following server connectivity options.
  - **Windows authentication credentials of current user** - Select this option if the credentials for logging on to Windows must be used for logging on to the database.
  - **Server authentication using the Login ID and password below** - Select this option if the SQL Server user name and password must be used for accessing the Compass database. When you select this option, the following fields are displayed.



**ATTENTION:** If you select Compass20 server from the drop down list, the server connectivity options are disabled as the Compass20 server is the local computer.

- 6 Click **Fetch Databases from Server** to obtain the list of databases present in the selected server. The list is refreshed in the **Database** drop down list.
- 7 Click **Change Database**. The Compass application points to the selected database.

### 9.3 Backup Database

The need of taking backup of Compass database arises when:

- Compass2.0 MSDE databases must be ported to SQL Express. The active version of Compass2.0 supports only SQL Express and not MSDE. The MSDE database can be backed up and restored to SQL Express.
- You want to ensure that another version of database is maintained in case there is a crash of the old database.



**ATTENTION**

The format of the Compass database remains the same even after the database is restored to SQL Express.

To take backup of a Compass database, perform the following steps:

Step	Action
1	Choose <b>Start &gt; All Programs &gt; Compass Windows Downloader &gt; DatabaseManagementUtility</b> . The <b>Database Management Utility</b> dialog box appears.

- 2 Select **Backup Database** option. The details of the active Compass database are displayed under **Existing Database Option**. The information is read only.

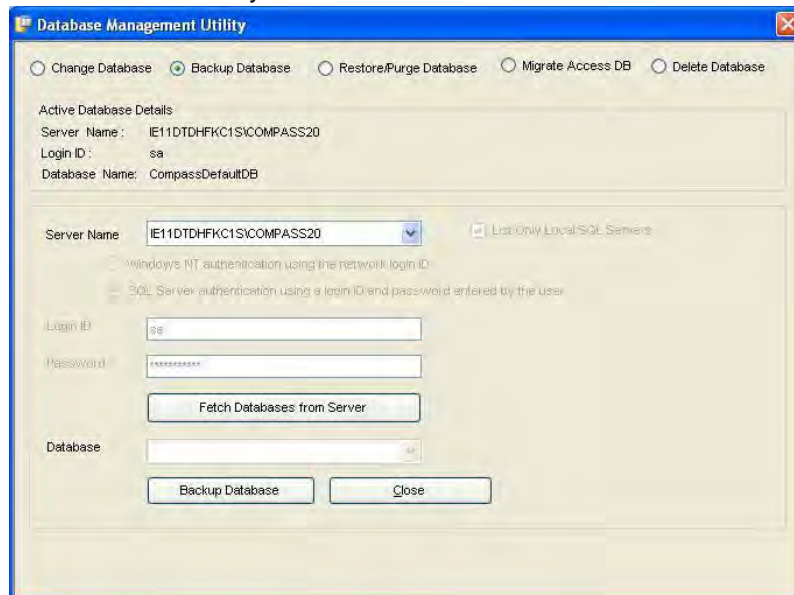

- **Server Name** - The name of the computer in which the active Compass database resides.
- **Login ID** - The login ID using which you can login to the server.
- **Database Name** – The active Compass database name.

- 3 Select the database **Server Name** from the drop down list.

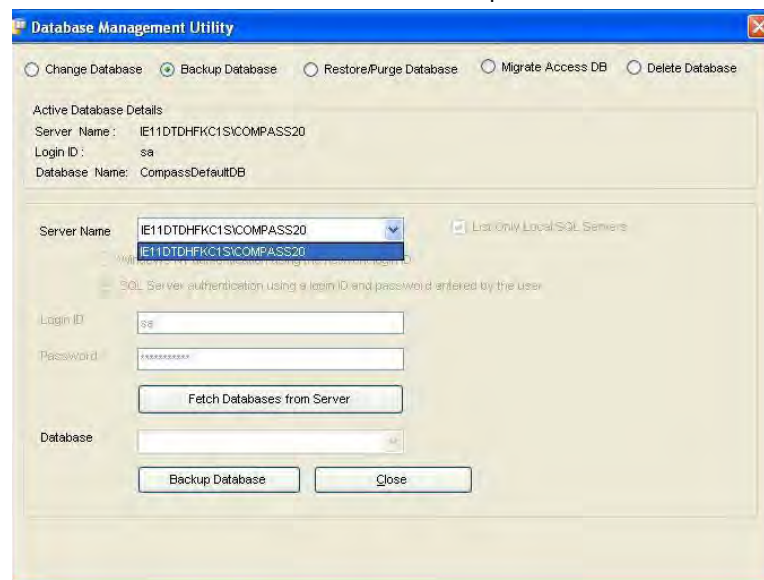

**ATTENTION:** As the databases listed are only those present in the local server, by default, the **List only local SQL Servers** check box is disabled.



- 4 Select one of the following server connectivity options.
  - **Windows authentication credentials of current user** - Select this option if the credentials for logging on to Windows must be used for logging on to the database.
  - **Server authentication using the Login ID and password below** - Select this option if the SQL Server user name and password must be used for accessing the Compass database. When you select this option, the following fields are displayed.



**ATTENTION:** If you select Compass20 server from the drop down list, the server connectivity options are disabled as the Compass20 server is the local computer.

- 5 Click **Fetch Databases from Server** to obtain the list of databases present in the selected server. The list is refreshed in the **Database** drop down list.
- 6 Click **Backup Database**. A backup of the Compass database is taken and the extension of the database file is .bak in the current computer. The database is stored in C:\CompassDatabase\Backup.

## 9.4 Restore/Purge Databases

### Restore Database

After the backup operation is complete, the database can be restored. The database becomes the active database only after it is restored.

To restore Compass database, perform the following steps:

Step	Action
1	Choose <b>Start &gt; All Programs &gt; Compass Windows Downloader &gt; DatabaseManagementUtility</b> . The <b>Database Management Utility</b> dialog box appears

- 2 Select **Restore Database** option. The details of the active Compass database are displayed under **Existing Database Option**. The information is read only.

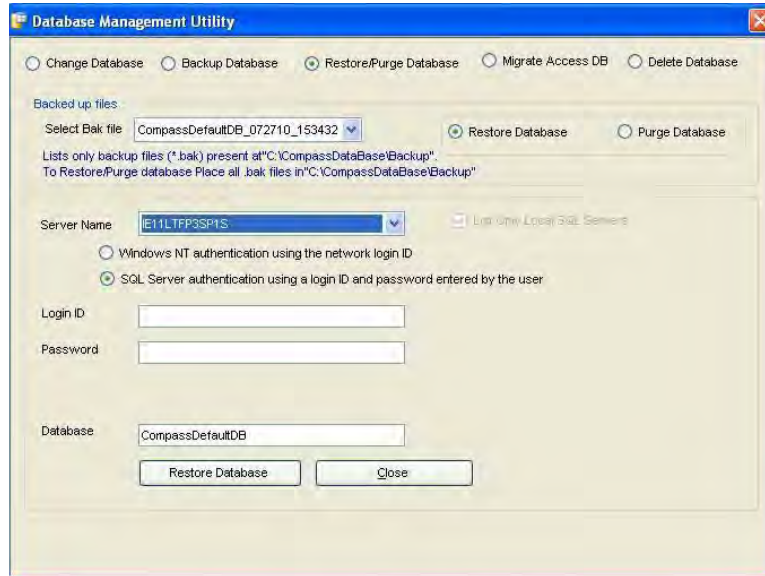

- **Server Name** - The name of the computer in which the active Compass database resides.
- **Login ID** - The login ID using which you can login to the server.
- **Database Name** – The active Compass database name.

- 3 Select the database **Server Name** from the drop down list.

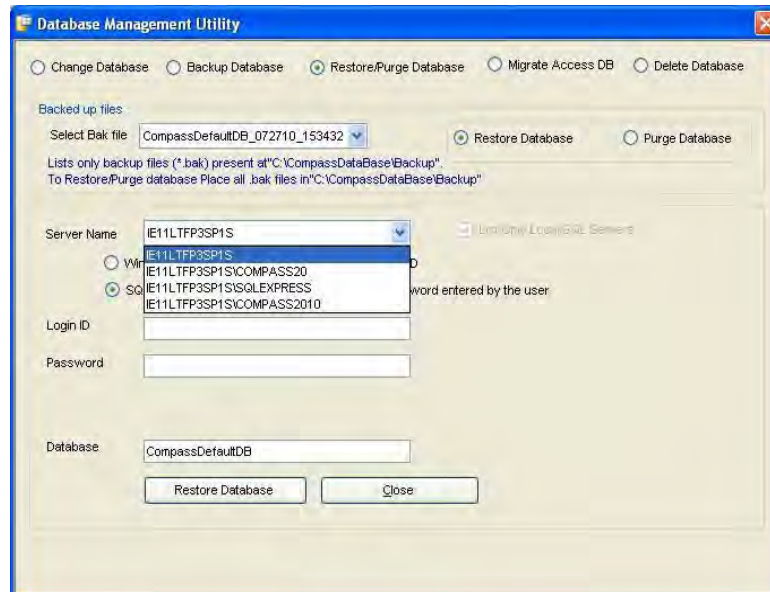

- 4 Select one of the following server connectivity options.
  - **Windows authentication credentials of current user** - Select this option if the credentials for logging on to Windows must be used for logging on to the database.
  - **Server authentication using the Login ID and password below** - Select this option if the SQL Server user name and password must be used for accessing the Compass database. When you select this option, the following fields are displayed.



**ATTENTION:** If you select Compass20 server from the drop down list, the server connectivity options are disabled as the Compass20 server is the local computer.

- 5 **Select Bak file** from the drop down list. The list is refreshed in the **Database** drop down list.
- 6 Click **Restore Database**. The database is restored successfully to the original path.

## Purge Database

After you delete the database from compass, it is not completely removed from the system. To remove the database permanently from the system, you may use the purge option.

To Purge database, perform the following steps:

Step	Action
1	Choose <b>Start &gt; All programs &gt; Compass Windows Downloader &gt; Database Management Utility</b> .
2	The following Screen appears. Choose <b>Restore/Purge Database followed by purge database..</b>

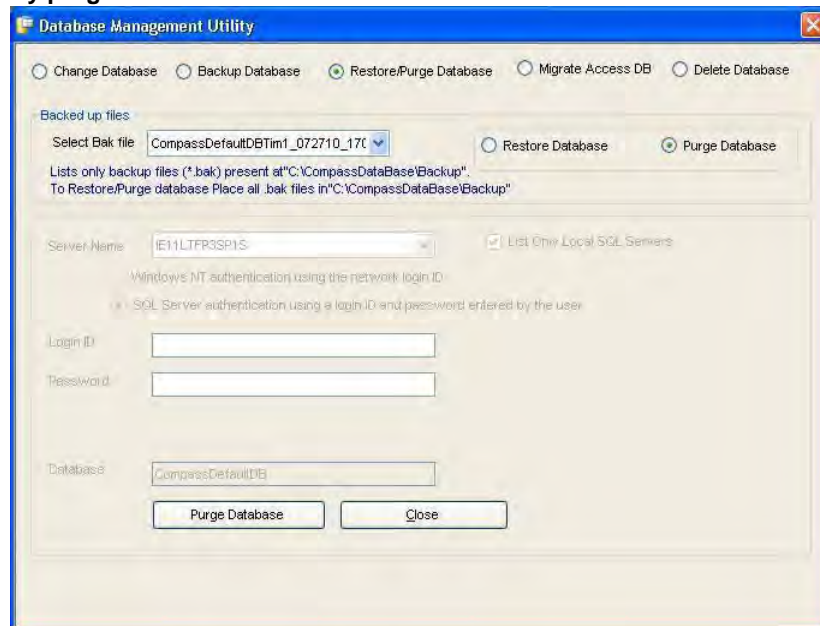

- 3 Choose the appropriate Database and click **purge Database**.

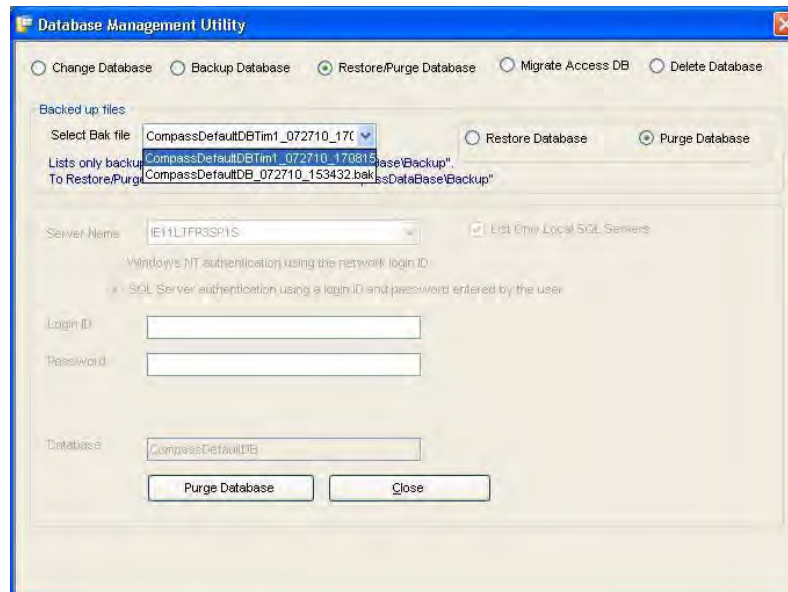

- 4 **Note:** All deleted databases will be present in the Backup folder. Only the files those are present in the C:\Compass\Database\Backup will only be available to purge and will be displayed in the Database dropdown.



**ATTENTION:** If you purge the database, the .bak file will be deleted permanently from the backup folder. Before purging the database, please make sure that you select the appropriate .bak file,

## 9.5 Migrate Database

To migrate all the user accounts present in the MS Access database to a new database in the local SQL server, perform the following steps:

Step	Action
1	Choose <b>Start &gt; All programs &gt; Compass Windows Downloader &gt; Database Management Utility</b> .

- 2 The following screen appears. Choose Migrate database..

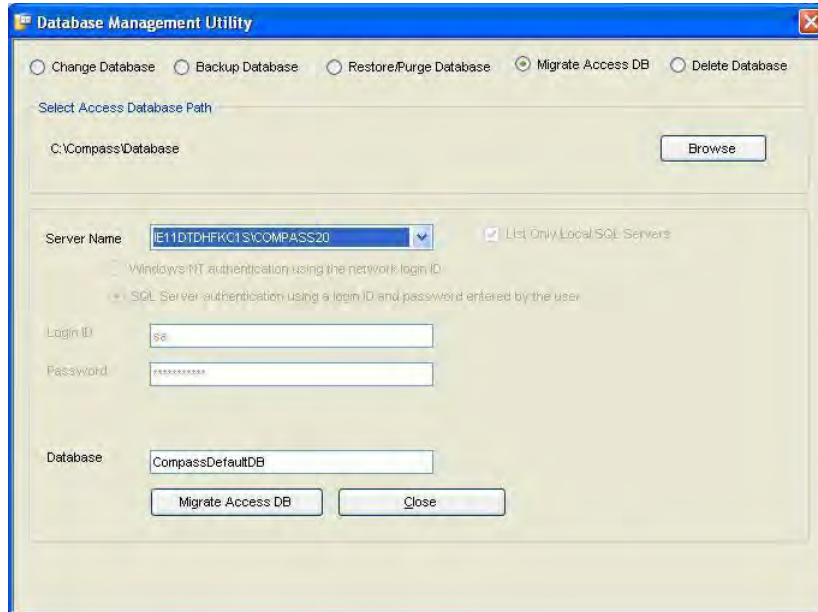

- 3 Click browse and perform the following:  
 Select the Compass 1.5.8.X directory on this computer to migrate your MS Access database to SQL Express.
- Note:** The database folder can reside anywhere in your Hard Drive or even in your USB Drive. However do not keep it on your Desktop or any mapped network drives and try to open as it may have access privilege issues.
- 4 Copy the three .mdb files: Download.mdb, History.mdb, and E20001.mdb, as well as, the system.mda file from Compass installed on another computer, to a folder in this computer and then convert the database
- Note:** The installation may take a while to migrate depending on the size of the database

## 9.6 Delete Database

To Delete database, perform the following steps:

Step	Action
1	Choose <b>Start&gt; All programs &gt; Compass Windows Downloader &gt; Database Management Utility.</b>

- 2 The following Screen Appears. Choose **Delete Database**..

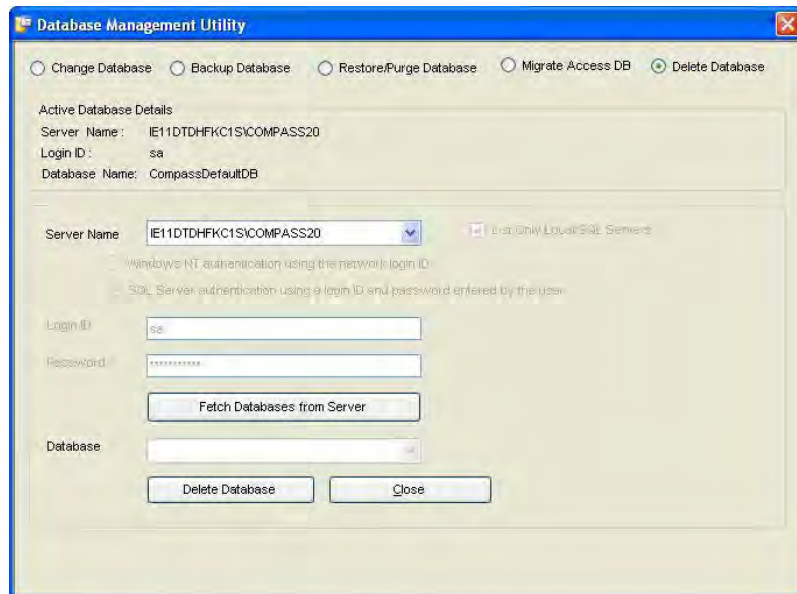

- 3 Click **Fetch Databases** from Server. The available databases are listed in the Database dropdown. Choose the appropriate one and click **Delete Database** button to delete the database.

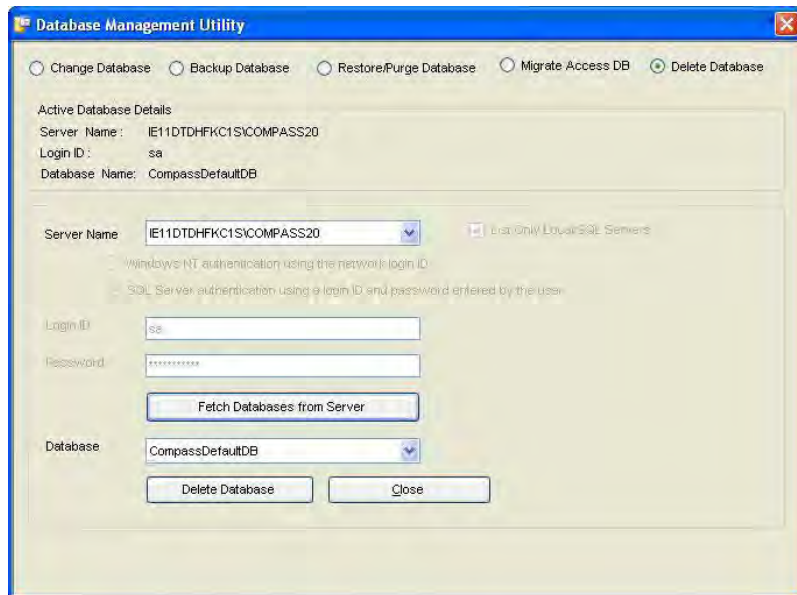

**ATTENTION:** Before deleting the database, ensure that no client is connected to the respective database. If the database is deleted from the server, the client ceases to work. After deleting the database, a file with .bak extension will be created in the backup folder. If you want to use the same database, you can restore it from DBMU.

## 9.7 Client Installation

The database backup and restore options in the **Database Management Utility** are available only with the Compass Standard installation. If Compass 2.0 is installed as a Client, the backup and restore options are automatically disabled.

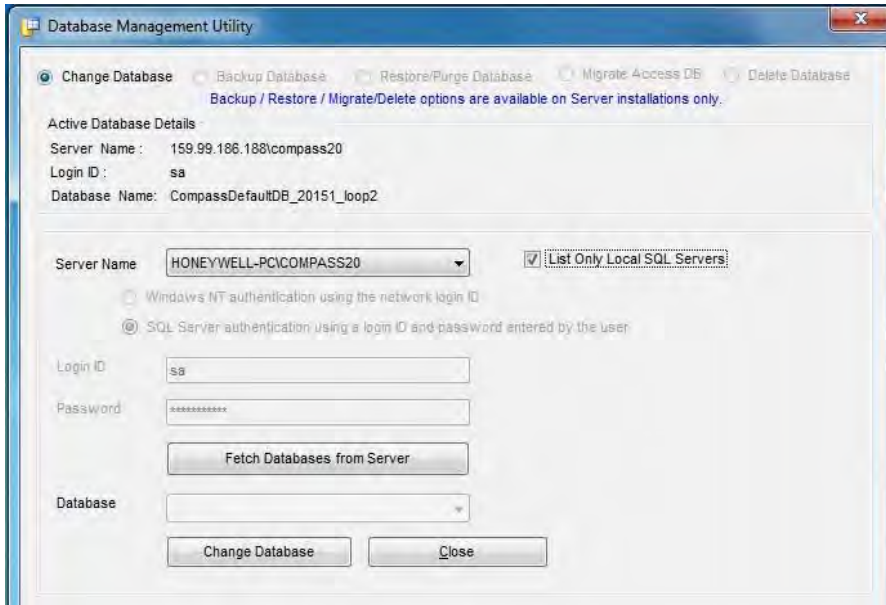

# 10. Bug Reporter

Bug reporter is a newly added feature for diagnostic purposes to trace an issue when it is reported. It is primarily designed to extract all the log files and the system related information from the system that would help in analyzing the root cause of an issue to give the fix for the same. Bug reporter creates a log file under C:\Windows\Compass\_Log with the extension '.clg'.

Bug reporter can be accessed in three ways:

- Access through Start up menu (choose Start>all programs>Compass Windows Downloader>Bug Reporter)
- Access through Compass application (Click Help> Report a bug)
- Access through Utility Folder (in the CD)

## Access through Startup Menu

Choose **Start>All programs>Compass Windows Downloader>Bug Reporter**

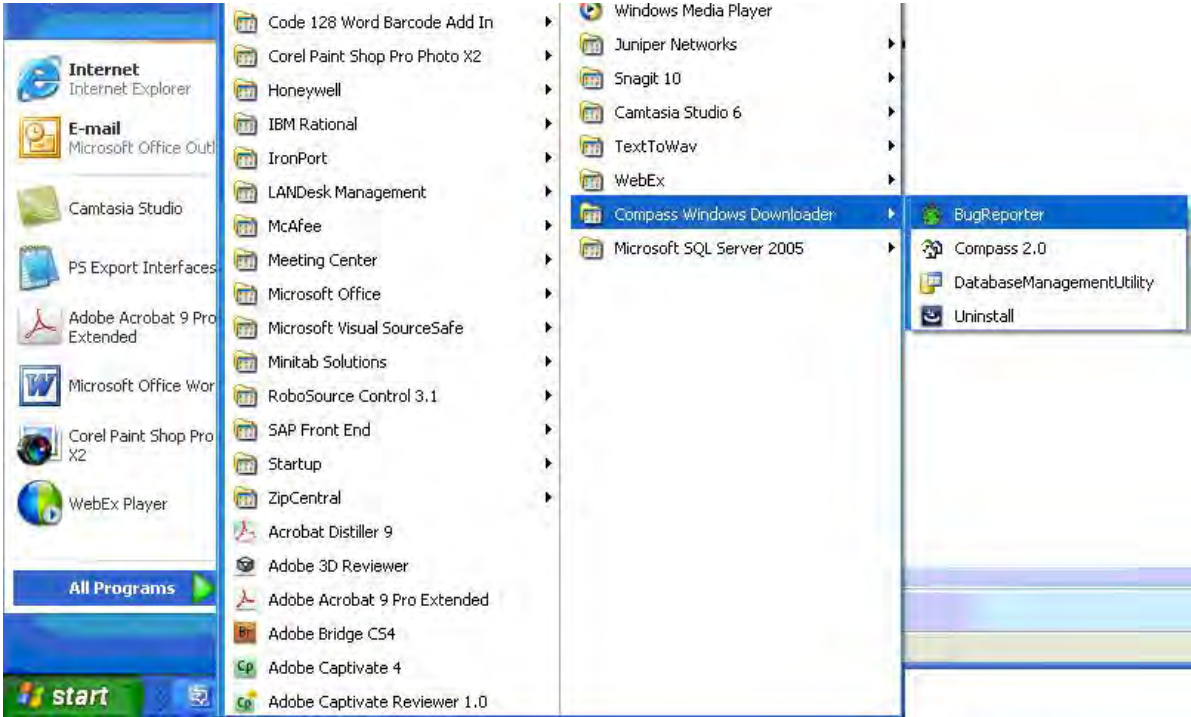

## Access through Compass Application

Choose **Help > Report a Bug**





### **Access through Utility Folder**

Bug Reporter is accessible through a separate folder that is provided inside the utility folder of the installation CD provided.

## 11. New Features in Compass 2.0

### 11.1 Overview

The new features in Compass 2.0 are summarized here.

- Drag and Drop Commands
- Common User Interface
- Single Window for Configuring Multiple Commands
- Simultaneous TCP/IP and dialup connection
- Activity Log
- Unattended/Unsolicited Mode Features
- Multiple Panel Usage
- Interactive Mode Features
- Export and Import Subscriber utilities
- Panels Report
- View all Customer Records
- Print Customer Detail
- Purge Event Log

### 11.2 Descriptions

Each of the new features is described in this section.

#### Selecting Commands using Drag-and-Drop

The drag-and-drop option is an alternative to the select and click method of selecting commands. This option is supported in both Interactive Communications and Scheduling mode for all the protocols.

To select a command, click the command from the Commands list and drag it to the Selected Commands list before releasing the mouse button. You can select multiple commands in one operation before dragging them.

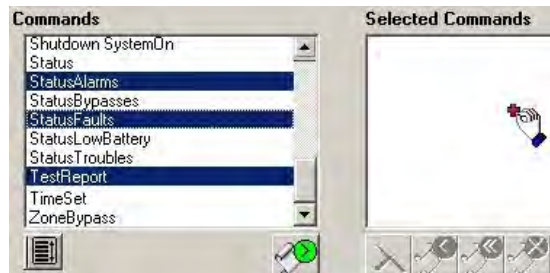

Figure 10-1 Drag and Drop Commands

## Common User Interface

The Communications UI for all the protocols share the same look-and-feel. Only the commands list differs from one panel to the other.

You can identify the panel by the Panel Name.

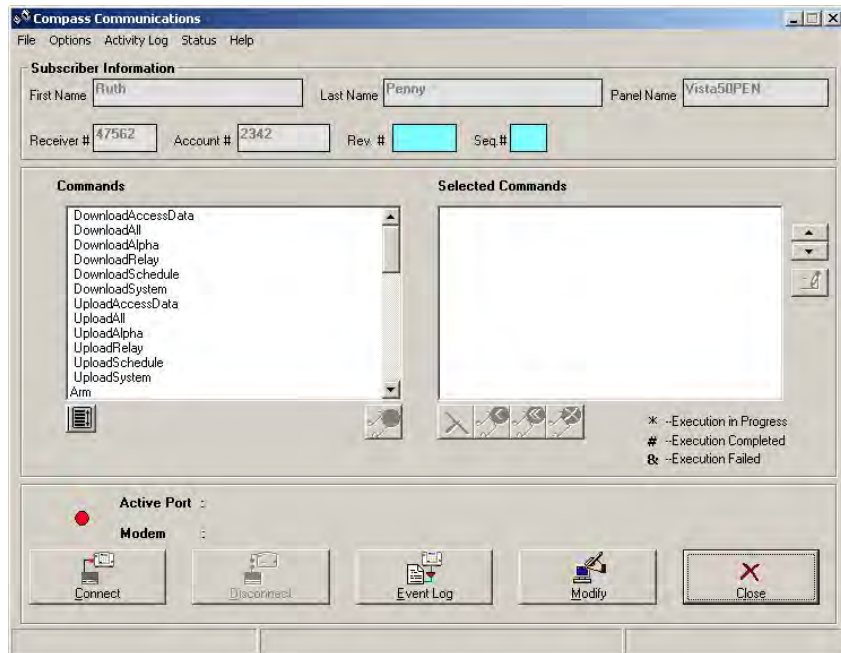

Figure 10-2 Compass Communications UI

## Single Window for Configuring Multiple Commands

If you have selected multiple commands that need user input for their processing, all the forms are displayed in a single window. This applies to both Interactive and Scheduled (Unattended) modes.

For example, if you have selected the **ChangePhone#** and **CsidChange** commands, both of which require user input, these can be configured in one **Command Details** window as illustrated below:

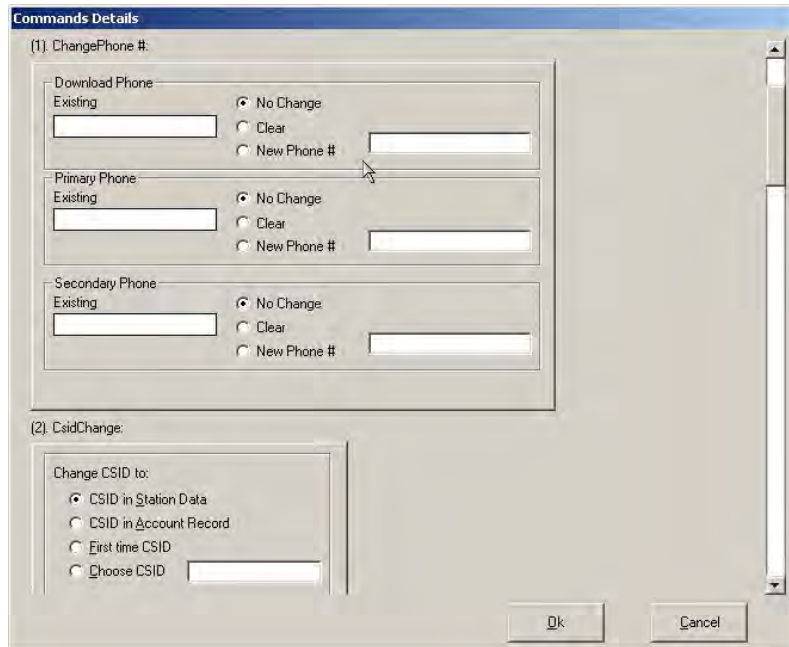

Figure 10-3 Common Window for Multiple Command Details

## Connecting through TCP/IP and Dialup Simultaneously

You can execute unattended jobs (for different Panels) through dial up mode and TCP/IP mode simultaneously (at different Ports).



## Activity Log

You can view or export the activity log in the interactive mode. If not required, you can disable this feature. The exported activity logs must be saved in a text format.

To view the activity log, click **Activity Log > View Activity Log** in the menu bar of the Compass Communications screen.





**TIP**

To access the **Compass Communications** screen, double-click the account in the Customer grid. Then, click **Communications** in the menu bar of the open panel.

The Activity Log is displayed as illustrated below. It lists the Commands that were run, the status of execution, and the date and time when the commands were processed. It also displays some messages if a certain command could not be processed as desired.

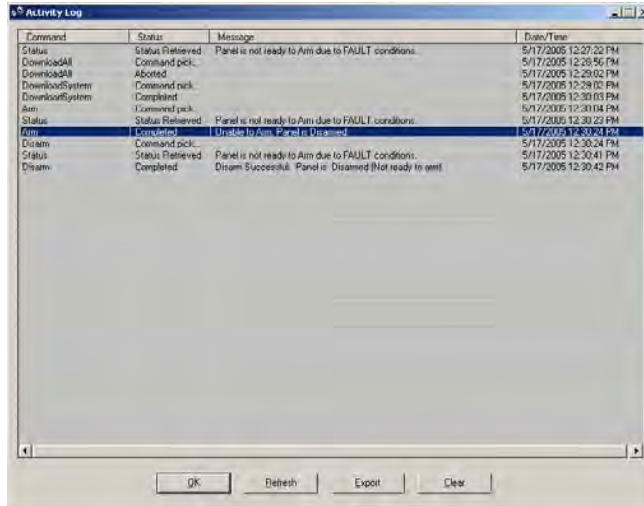

**Figure 10-4 Activity Log - Interactive**

In the Scheduled Mode, the activity log generated can be saved in the text format, or printed.

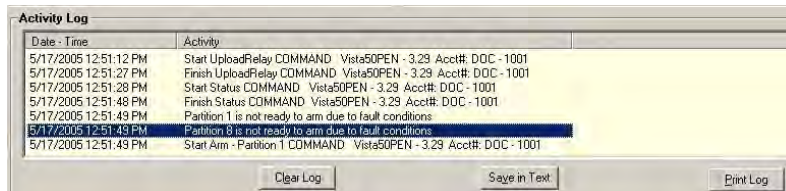

**Figure 10-5 Activity Log - Unattended**



**REFERENCE- INTERNAL**

For more information regarding Activity Log in the Unattended Mode, refer to step 10 of [Scheduling Ademco Unattended Jobs](#).

## Unattended/Unsolicited Mode Features

The following are some of the new features implemented in the Unattended Mode:

- A single UI caters to all the protocols and multiple ports.
- The Unattended UI shows details of the job in the queue.
- The Viewer UI shows the offline status message for an account.
- You can modify the commands that require user input, with new values, when rescheduling an Unattended batch.
- Compass 2.0 supports the Unattended mode for Apex.
- When you launch the Unattended UI, you can use the **Auto Save** option to automatically save uploaded information in the Unattended mode.



### REFERENCE- INTERNAL

For more details on Unattended Mode and its features, refer to [7. Unattended Communications](#).

## Working with Multiple Panels

You can schedule jobs for any number of panels, even while one of the panels is open. Only jobs for the open Panel Application cannot be scheduled. You can schedule jobs for one panel, and while the job is executed, schedule the next (other than the open panel).



### REFERENCE- INTERNAL

For more information on scheduling, refer to [7. Unattended Communications](#).

## Interactive Mode Features

The following are some of the new features implemented in the Interactive Mode:

- You can stop the execution of a command before it is finished.
- The Event Log shows you the list of all commands that have been executed previously in the Interactive mode. This is a new feature for Apex and FBII protocols. The Event Log can be viewed from the Shell (**View Log** under **Panel Options** in the bottom toolbar) or from the **Compass Communication** screen (**Event Log** in the bottom Toolbar).
- You can view offline status messages for an account.
- Event Log, ECP Details and Fire Test Reports are saved automatically to the database. This is a new feature for Ademco protocol.



### REFERENCE- INTERNAL

For more details on Interactive Mode and its features, refer to [6. Interactive Communications](#).

## Export and Import Subscriber

This feature provides the ability to export/import customer information from the Compass application.

## Exporting Subscriber Information

You can export the subscriber details into a text file or an Excel sheet using the Export Subscriber feature.

To export the subscriber information, perform the following steps:

Step	Action
1	In Compass 2.0 Shell, click <b>Tools&gt;Export Subscriber</b> . The Define Export Sources dialog box is displayed.

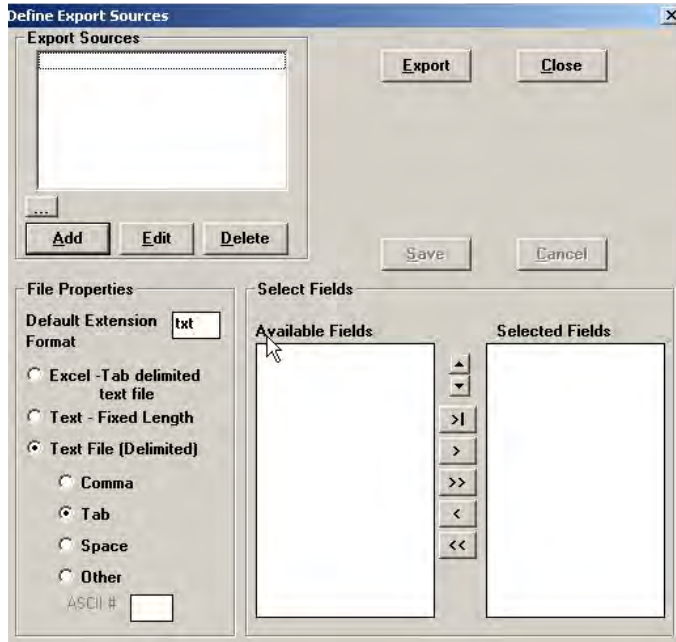

- Click **Add**.  
The Add Export Source dialog box is displayed.

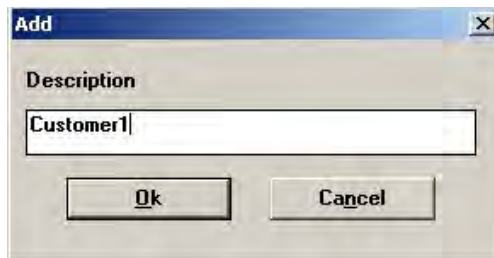

- Type a **Description** to the export source (For example, Customer1) and click **Ok**.  
The column headings in the customer information screen are displayed in the **Available Fields** listbox.

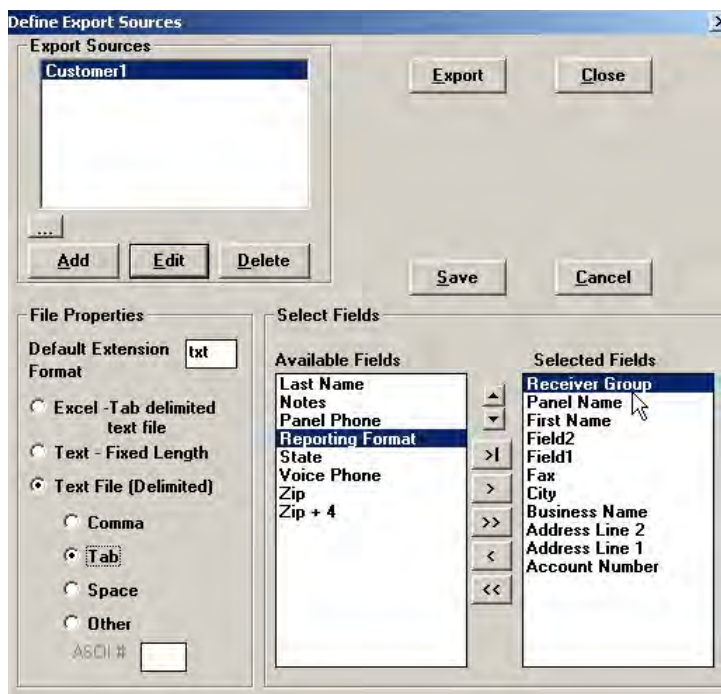

4 From the **Available Fields** list, select the fields that you want to export.

Click the > arrow to move the fields to the **Selected Fields** list and the arrows to sequence the list in the order in which you want to export it.



**TIP:** The arrows help you move the fields between Available and Selected lists

- moves the selected item to the cursor position in Selected Fields
- moves the selected item to the end of the Selected Fields list.
- moves the entire list from Available Fields to Selected Fields
- moves a single Selected Field entry to Available Fields
- moves all Selected Fields to Available Fields



**ATTENTION:** The import action can be performed only if the **Reporting Format** field is not included in the text file. So if the data needs to be imported, you must ensure that the Reporting Format is not one of the selected fields while exporting.

5 In **File Properties**, specify the file type and format from the list of options. You can save the details as an Excel file or a text file.

6 Click **Export**.

The Select Path to Export Subscribers dialog box is displayed.



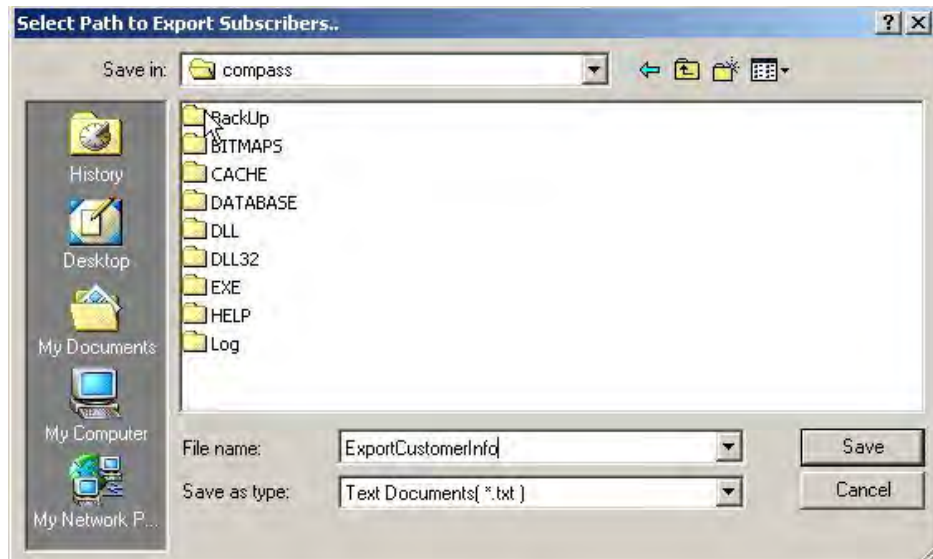

- 7 Type a name for the file.
- 8 Select the desired destination and click **Save**.
- 9 Click **Close** in the Define Export Sources dialog box to close it.  
The saved file (ExportCustomerInfo.txt) contains details of the subscribers as displayed on the customer screen of the Compass Shell.

## Importing Subscriber Information

The file generated using Export Subscriber can be imported to the customer screen.

To import subscriber information, perform the following steps:

Step	Action
1	In Compass 2.0 Shell, click <b>Tools&gt;Import Subscriber</b> . The Define Import Sources dialog box is displayed.

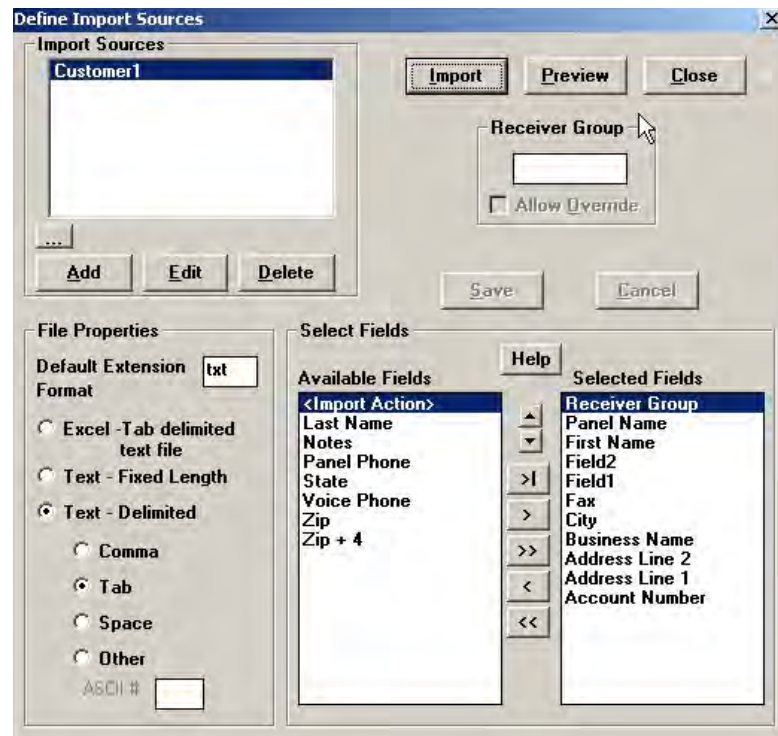

- 2 If the source is not defined, click **Add** and type a description for the source.  
 **REFERENCE- INTERNAL:** For more information on adding a new Import Source, refer to [Importing Information from Other Sources](#).
- 3 From **Select Fields**, select the appropriate Fields from the available fields.
- 4 From **File Properties**, select the format for the file imported.

- To preview the import source, click **Preview**.  
The Test "ImportSourceName" dialog box is displayed showing a preview of the Import file. The selected fields are displayed as columns in the same order of selection.

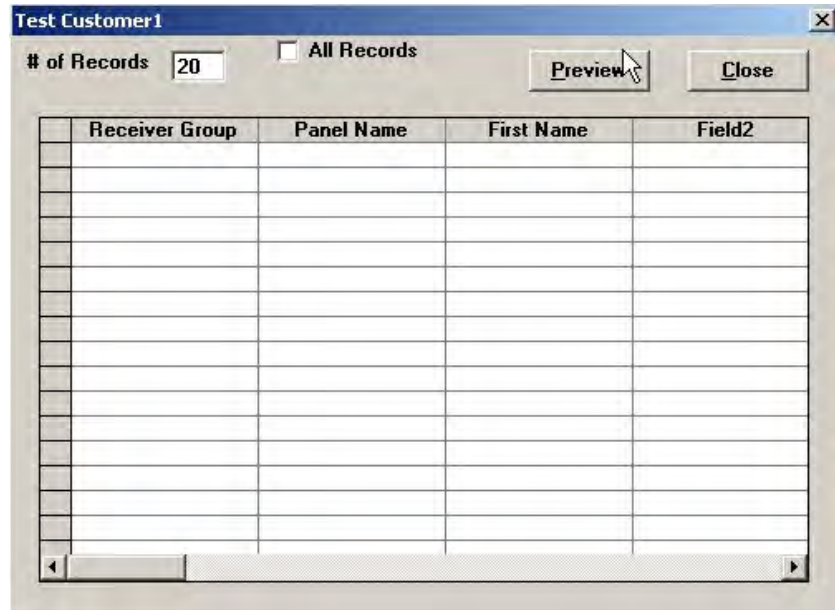

- Click **Preview** in Test "ImportSourceName" to select the file that contains customer information, which was saved during export.

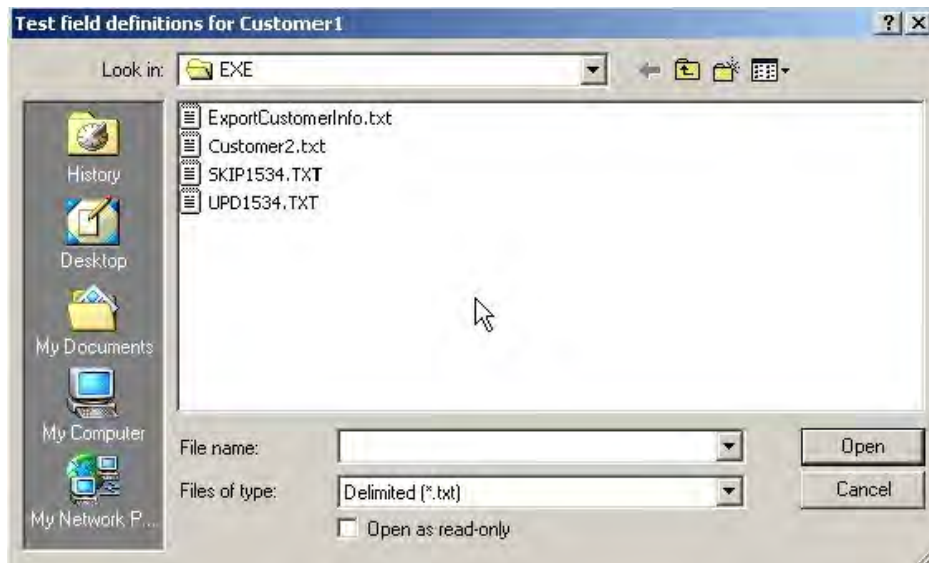

- Select the exported file and click **Open**.  
The Test "ImportSourceName" dialog box is displayed with the records.

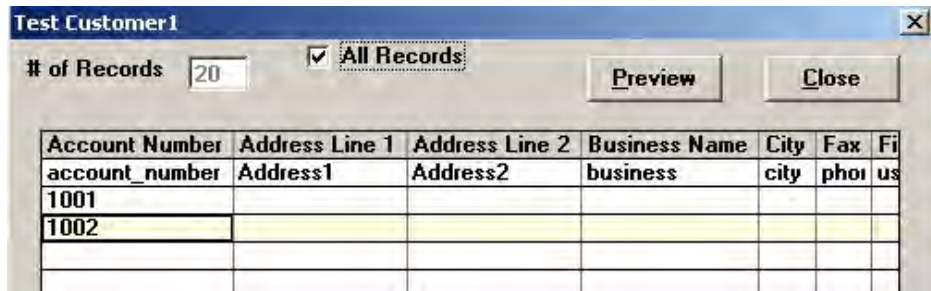

- 8 Click **Close** after viewing.
- 9 In the Define Import Sources dialog, type the account number from which the data importing should begin. Select **Ignore Header Row** if you do not want to import the header.
- 10 Click **Import**.

The **Import Subscribers** dialog box is displayed. To start importing from a particular account number, type the number in the **Starting Account No.** text box.

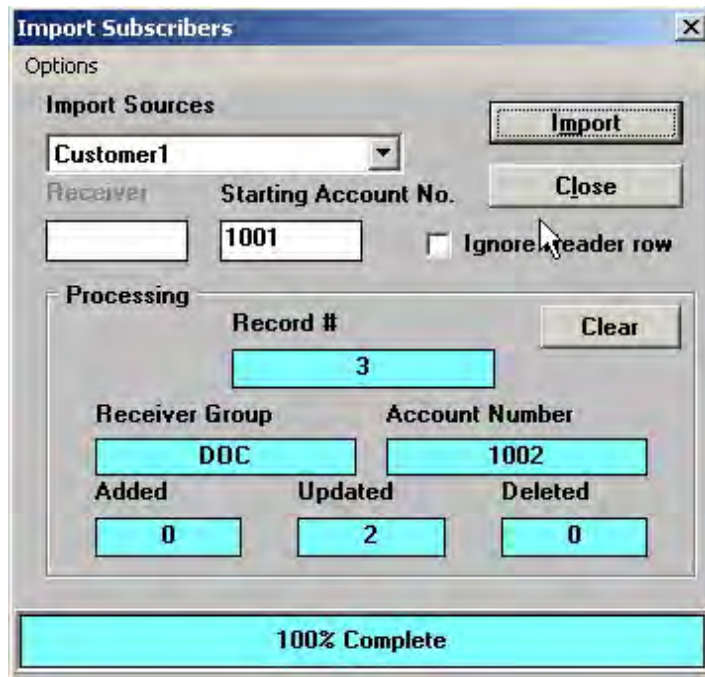

- 11 Select a source from the **Import Sources** drop-down list, if it is not already displayed by default.
- 12 Click **Import**.  
The Import Subscribers from ... dialog box is displayed.

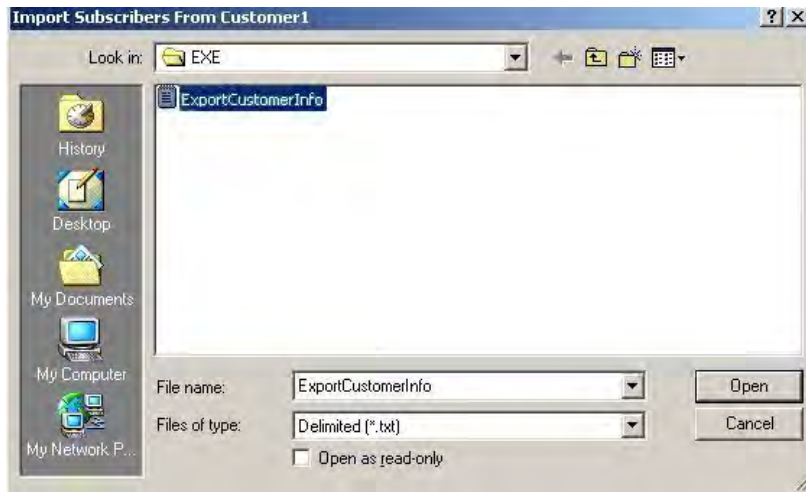

- 13 Select the required file and click **Open**.
- 14 The text boxes with a blue background, under **Processing**, show the status of processing of the import command.
- 15 Click **Close** to close the Import Subscribers dialog box.
- 16 The information in ExportCustomerInfo.txt is imported to the customer screen.

### Import Subscribers – Options

With the Import Subscriber Options, you can choose to import details of a new customer, or modify information of existing accounts, or both.

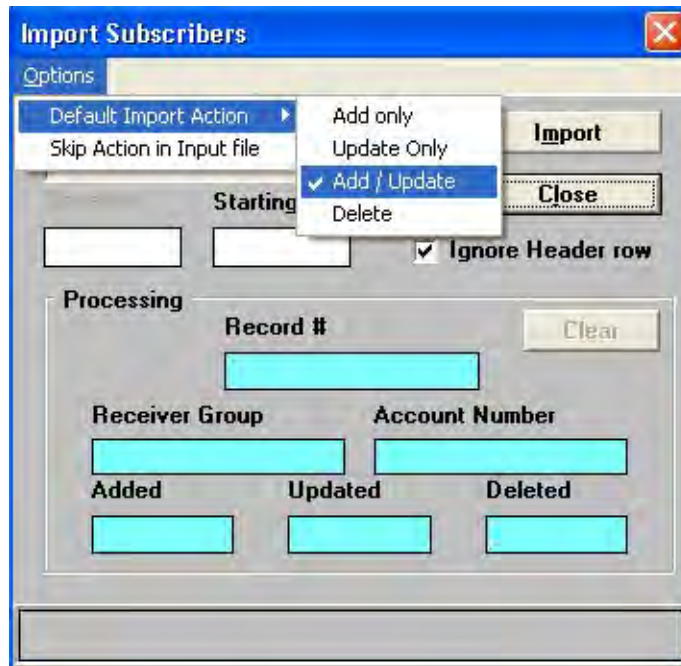

Figure 10-6 Import Subscribers – Options

Option	Description
Default Import Action	<p>The default actions are:</p> <p><b>Add Only</b> –You can only add new accounts where the Receiver number-Account number combination is different.</p> <p><b>Update Only</b> – You can only update customer details of the accounts already present in the list. No new accounts can be added.</p> <p><b>Add/Update</b> – You can add new accounts or update/modify information of existing accounts.</p> <p><b>Delete</b> – You can delete the existing accounts.</p>
Skip Action in Import File	<p>Import Action is a one character field that specifies the actions to take with records in the input file. It is one of the <b>Available Fields</b> in Define Import Sources dialog box.</p> <p>You can select this option to skip the action mentioned in the Import File.</p> <p>Select <b>&lt;Import Action&gt;</b>in Available fields and click <b>Help</b> for more details.</p>



## Importing Information from Other Sources

The Export Source is available in the Import Sources list only if the export/import operations are done in the same Compass network. If you have to import a file given by any other source (third party) to your Downloader, follow the instructions given below:

Step	Action
1	<p>Click <b>Add</b> in the Define Import Sources dialog box. The Add dialog box is displayed.</p>
2	<p>Type the Description (name of the import source) and click <b>Ok</b>.</p>
3	<p>From the <b>Available Fields</b> list, select the fields that you want to import. Click the <b>&gt;</b> arrow to move the fields to the <b>Selected Fields</b> list. To move the entire list, click <b>&gt;&gt;</b>.</p>
4	<p>Click <b>Save</b>. The selection is saved to the new import source.</p>

- 5 Follow the steps 3 to 16 of [Importing Subscriber Information](#).  
The data from the text file is imported to the Import source and is displayed in the same order as the **Selected Fields**.



**REFERENCE- INTERNAL**

You can also Export and Import Accounts. For more details refer to [4.9 Exporting and Importing Accounts](#).

## Panels Report

A new utility for generating a report on the panels being used by a Compass system is provided. However, this newly added feature can work with Compass 16 and does not require the installation of Compass 2.0.



**REFERENCE- INTERNAL**

For more information refer to [Exporting Panel Usage 9.4 Exporting Panel Usage](#).

## Viewing All Customer Records

You can view all customer records from the Shell. A single page displays 1024 records. You can move to the next page or previous page.

## Printing Customer Detail

To print customer details, perform the following steps:

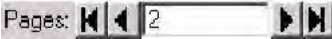
Step	Action
1	Select the row/customer whose details you would like to print from the Customer screen.
2	From the <b>File</b> option in the menu bar, select <b>Print</b> . A form is displayed, which shows the customer details.  <b>TIP:</b> You can move to the first, last, previous, or next customer detail using the  button at the bottom left of the screen.
3	Use Print Setup to configure the details of printing.

You can print only the details of one customer at a time. The customer details are printed as illustrated below.

**CUSTOMER DETAIL**

**SUBSCRIBER DATA**

<b>Receiver</b> <input type="text" value="DOC"/>	<b>Account</b> <input type="text" value="1001"/>	<b>Last Name</b> <input type="text" value="-"/>	<b>First Name</b> <input type="text" value="-"/>
<b>Business</b> <input type="text" value="-"/>		<b>Voice Phone</b> <input type="text" value="-"/>	<b>Fax</b> <input type="text" value="-"/>
<b>Address 1</b> <input type="text" value="-"/>		<b>Address2</b> <input type="text" value="-"/>	
<b>City</b> <input type="text" value="-"/>	<b>State</b> <input type="text" value="-"/>	<b>Zip Code</b> <input type="text" value="-"/>	<b>Zip Ext.</b> <input type="text" value="-"/>
<b>user_defined_field</b> <input type="text" value="-"/>		<b>user_defined_field</b> <input type="text" value="-"/>	

**PANEL DATA**

<b>Panel</b> <input type="text" value="Vista50PEN-1"/>	<b>Revision</b> <input type="text" value="Vista50PEN"/>
<b>Class</b> <input type="text" value="-"/>	<b>Panel Phone Number</b> <input type="text" value="8198"/>
<b>Caller ID</b> <input type="text" value="-"/>	

**Figure 10-7 Printing Customer Detail**

## Purge Event Logs

Operators can now delete the Event Log data from the Compass database using this utility.



**REFERENCE- INTERNAL**

For more information, refer to [Purging Event Logs 4.7 Purging Event Logs](#).

## Other Important Features

The other important features of Compass 2.0 are:

- **Templates** for quick and easy programming of control panels.



**REFERENCE-INTERNAL:** For more information, refer to [5.4 Using Templates](#).

- A full **search** utility to help you quickly finds a programming field.



**REFERENCE-INTERNAL:** For more information, refer to [4.5 Searching/Sorting Customer Data](#).

- Multi-tiered **operator levels** for greater flexibility.



**REFERENCE-INTERNAL:** For more information refer to [3. System Operators](#).

- **Change** button to display programming changes made before saving.
- **History** button to display prior programming changes.





# APPENDIX A

## Error Conditions

Error	Solution						
Cannot find a DLL or VBX file	Manually copy the files giving the error from the DLL subdirectory of Compass to the Windows/system directory.						
xx parameters expected, but none supplied	<p>This error occurs if the database is not synchronized properly at the end of an installation. Try running the database synchronizer again. It is possible that a DLL or VBX was not properly moved to the Windows System directory, or that the Compass upgrade was installed onto a different directory and not the original directory.</p> <p>To see the directory where Compass was installed, run Compass and check the database path on the login screen. The beginning of this path, before the \database\download.mdb, is the location of the previous installation. If this path is not the same as the upgrade, change the path to match the upgrade directory.</p>						
"Decode.dll" error message.	<p>Report this error to Ademco for repair, along with the following information:</p> <ul style="list-style-type: none"> <li>• The panel type.</li> <li>• The type of error: "vb value invalid", "vb type length", "nibble length", etc.</li> <li>• The glf_id and the repeat.</li> </ul> <p>Export the account and send it to technical support.</p>						
Cannot find system.mda when repairing network database locally	<p>This is caused when the Database Repair program cannot find system.mda in a local exe subdirectory, and the download.mdb in a local database subdirectory (For example: C:\compass\exe and c:\compass\database).</p> <p>Copy the system.mda into C:\ Compass\ database, then run the Repair utility.</p>						
Compass running on a Novell Server suddenly stops allowing anyone to add new accounts.	<p>The reason for this error is that the Novell Server runs out of locks. Novell defaults are:</p> <ul style="list-style-type: none"> <li>• Max Records per connection 500&gt;&gt;10,000</li> <li>• Max File Locks per connection 250&gt;&gt;350</li> <li>• Max Record Locks?&gt;&gt;20,000</li> </ul>						
"Permission denied, cannot open system.ldb" error message.	<p>This error message may occur when running netload.exe from a peer-peer network. Netload.exe is designed to speed up a network installation. To solve this problem, perform the following steps:</p> <table border="1" data-bbox="537 1556 1354 1745"> <thead> <tr> <th data-bbox="537 1556 594 1583">Step</th> <th data-bbox="683 1556 756 1583">Action</th> </tr> </thead> <tbody> <tr> <td data-bbox="537 1608 553 1635">1</td> <td data-bbox="675 1608 1094 1635">Load the full installation on the network.</td> </tr> <tr> <td data-bbox="537 1661 553 1688">2</td> <td data-bbox="675 1661 1354 1745">Change the shortcut for each of the client machines to run netload.exe from the server instead of download.exe on the local computer.</td> </tr> </tbody> </table>	Step	Action	1	Load the full installation on the network.	2	Change the shortcut for each of the client machines to run netload.exe from the server instead of download.exe on the local computer.
Step	Action						
1	Load the full installation on the network.						
2	Change the shortcut for each of the client machines to run netload.exe from the server instead of download.exe on the local computer.						



**REFERENCE– INTERNAL:** For information on technical support, refer to Technical Support.

- 
- 3** Netload checks the network drive to see if any of the files in the exe, dll, or bitmap folders have been updated.
- If any files are newer than those on the client machine, they are copied to the appropriate local c:\compass\ subfolder. The client machines are updated automatically without having to run an individual installation on each machine.

Alternatively, you can set up a partitioned drive (d:) on the server and install Compass to that drive. The server and all client machines can then run netload.exe. Only a network administrator can change these settings. The Head of the downloading department cannot typically change these settings.

"3041 Incompatible database" error messages.

This error occurs when the paging software is running in the background using an older version of either MSAJT200.DLL or MSAJT112.DLL. This software has loaded the older version of these dlls to memory. To fix this situation, don't run the paging software at the same time as Compass. Search to find these 2 dlls on the system. Compass puts them into c:\windows\system.

It is likely that this paging software has the dlls in its local directory. If this is true, rename the dlls in the paging software directory to \*.wdl. Let the paging software use the newer dlls installed and see if the two software packages can both run this way. Always start Compass first and then start the paging software so as to keep the newer dlls in memory.

muscle.vbx can not be located

If you are using Windows 95, 98, ME, or XP, copy the contents of the folder at X:\compass\dll (where X= server drive) to the local machine at C:\windows\system. If you are using Windows NT or 2000, copy the contents to C:\winnt\system.

Make sure to copy it to the system folder and not the system32 folder. Reboot the computer.

Error line: 6005 3044  
C:\compass\databas  
e\ download.mdb  
isn't a valid path

Perform a search for the file "download.ini". It is located in the C:\windows or C:\winnt directory.

Open the file and find the line "mdbpath=C:\compass\database." Change this line to point to the database located on the server. For example, "mdbpath=X:\compass\database."

Click the File, and then Save. Close the file and run netload.exe.

---

# **Index**

## **A**

Ademco  
    Launching Commserver 81  
    Unattended Jobs 111  
Ademco Unattended Jobs 111  
Alarm Control Programming 39  
    Communications 41  
    Menu Bar 40  
    Search 41  
    Using Templates 76  
    View 41  
Alternate Protocol 89  
Answer on Two Rings 89  
Answering Machine Defeat 85, 90, 120  
Apex  
    Launching Commserver 95  
    Unattended Mode 121  
Auto Save 110

## **B**

BackupDatabase 140  
Beep on Connect 89  
Busy Detect 89  
Bypass 136

## **C**

Call Unsolicited Server 120  
Caller ID 89  
Central Station ID 17  
ChangeDatabase 138  
Commands 124  
    Arming/ Disarming 132  
    Change CSID 129  
    Change Phone# 130  
    List 125  
    Messages 131  
    Test Report 137  
Common User Interface 152

Communication Server 81  
    Commserver See Communication Server  
    81  
Compass Downloader 1  
    About 4  
Customer Information 25  
    Adding Customer Accounts 25  
    Changing Customer Account Information  
    27  
    Customizing the Customer Account  
    Screen 34  
    Deleting Customer Accounts 27  
    Restoring/Purging Customer Accounts  
    28  
    Searching/Sorting Customer Data 29

## **D**

DatabaseManagementUtility 138  
Direct 85  
Download Warning 89  
Drag and Drop 151

## **E**

Error Conditions 167  
Event Log 90  
Exporting and Importing Accounts 33

## **F**

FBII  
    Launching Commserver 91  
    Unattended Mode 118  
FBII F7702 Interface 11  
First Time Communication 88  
Flexible Callback 87

---

**H**

Hayes Smartmodem 1200 (B) Internal Modem 15

Hayes Smartmodem 1200 External Modem 15

**I**

Information 104

**L**

Latest Patch Information 7

Log On 1

Log-On 1

**M**

Mapping Devices to IP 16

Merge Compass Database 142, 151

Mixed Mode 100

Modem Setup 8

Modem Switch Settings 14

Modems

    Add Modems 12

    Delete Modem 14

    Edit Modem 13

**N**

New Features 151

**O**

Output 70

**P**

Panel Application for Compass 2.0 43

Panels Supported by Compass 2.0 5

Phone line Hunt group 110

Print Customer Detail 164

Product Updates 7

Purging Event Log Data 31

Purging History Data 30

**R**

Renaming Receiver Group 32

RestoreDatabases 142, 148

**S**

Scheduled Mode 100, 107

Scheduler Activities Viewer 111

Select CSID to Use 110

Select CSID to use 110

Serverauthentication 140

Station Data 17

System / Software Requirements 2

System Operators 21

    Access Definitions 22

    Changing Operator Names 23

    Changing Operator Passwords 23

    Deleting Operators 24

    Updating Operator Information 24

System Options 52

**T**

Technical Support iv

Telco 85

Template 13

Time 95, 110, 133

**U**

Unattended Communications 100

Unsolicited Mode 100, 115, 116

USE ACCOUNT CSID 88

User-Defined Fields 19

---

## V

Viewing Unattended Jobs 35, 102

## W

Windowsauthentication 140

